

AcuSplitCT Series 50/100/150A

Hinged Split Core Current Transformers

The Accuenergy hinged split core CTs are compact and low-cost current transformers with high accuracy. Designed with a single-click installation mechanism, the hinged CTs are ideal for quick and easy installation without disconnecting cables. The compact size is perfect for limited-space panels.



SPECIFICATIONS

Rated Input & Output	333mV@ 50/100/150A AC
Accuracy	0.5%
Frequency Range	50-1KHz
Window Size	1.0 Inch
Case Material	Black Nylon
Rated Voltage	600 Vac, Category III
Note: Do not use 600V class CT in application with voltage greater than 600V L-L	
Operating Temperature	-15°C - 60°C
Certifications	UR & CE approved, RoHS compliant

DIMENSIONS

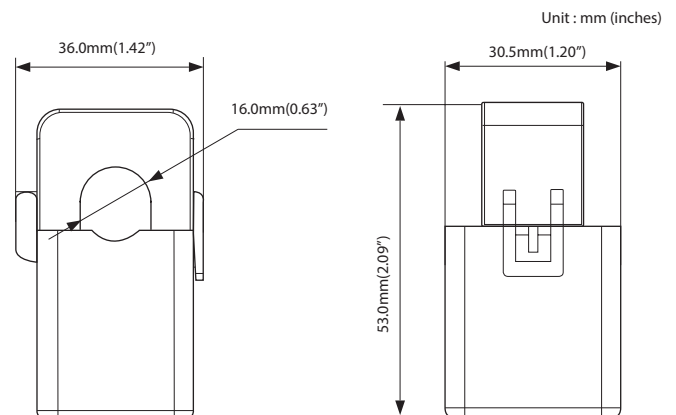

ORDERING INFORMATION

Ordering Number:	Rated Input	
AcuCT- H063 -	333	
Ordering Example: AcuCT- H063 -	50	: 333
	50: 50A	
	100: 100A	
	150: 150A	



Accuenergy Corp.

Los Angeles-Toronto-Beijing

North America Toll Free: 1-877-721-8908

Web: www.accuenergy.com

Email: marketing@accuenergy.com

ACCUEENERGY
Your Power and Automation Partner