

ACCUEENERGY



CATALOGUE

Table Of Content

About Accuenergy	3
Accuenergy Meters	4
Acuvim 3 - Advanced Power Quality Meter.....	4
Acuvim II - Advanced Multi-Function Power & Energy Meter Series	6
Acuvim II - Expansion Modules.....	8
Acuvim II + AXM-WEB2.....	9
Acuvim L - Standard Multi-Function Power & Energy Meter Series	10
AcuRev 1310 - DIN-Rail Digital Panel Meter.....	12
AcuRev 2100 - Multi-Circuit Submeter with SnapOn CT Technology	14
AcuDC 240 - DC Energy Meter.....	16
AcuDC 300 - EV Charging Meter	18
UL 508A Panel Shop - Industrial Control Panel Solutions	20
AcuPanel 9100 Series - Pre-Wired Metering Panels	22
Communications	24
AcuLink 810 - Data Acquisition Gateway.....	24
AcuMesh - Wireless RS485 Metering Network	26
Current Transformers	27
AcuCT Flex - Rogowski Coils.....	27
RCT GRIP Kit - Rogowski Mount Installation Kit.....	27
RIK Series - Rogowski Integrator Kit.....	28
AcuCT R - Revenue-Grade Split-Core Current Transformer.....	29
AcuCT S - Solid-Core Current Transformer	29
AcuCT mV - 333mV Split-Core Current Transformer	30
AcuCT Hinged - 5A Split-Core Current Transformer.....	30
AcuCT 5A - 5A Split-Core Current Transformer.....	30
AcuCT C - Current Transformer Converter	30
DC Shunts - Shunt Series	31
DC Sensors - DC Current Sensors.....	31
HV2 - DC Voltage Sensor	31
Energy Services	32
Field Services	32
AcuCloud - Energy Management Software.....	34
Coming Soon.....	36



We Are Accuenergy

Accuenergy Inc. specializes in power metering solutions that lead the industry in revenue grade energy metering, power quality analysis, ease of deployment and advanced communication methods. Our reliable power meters are used globally to monitor electrical systems in commercial and industrial facilities, multi-tenant buildings, data centres, and cell towers for more than 25 years.

Our goal is to provide users with reliable products that are easy to implement with powerful key functionality. Our pre-wired panel meters, submeters, energy management software, and sensors are designed to offer the simplest tenant billing and metering solutions on the market, while providing ease of installation.



ACUVIM 3

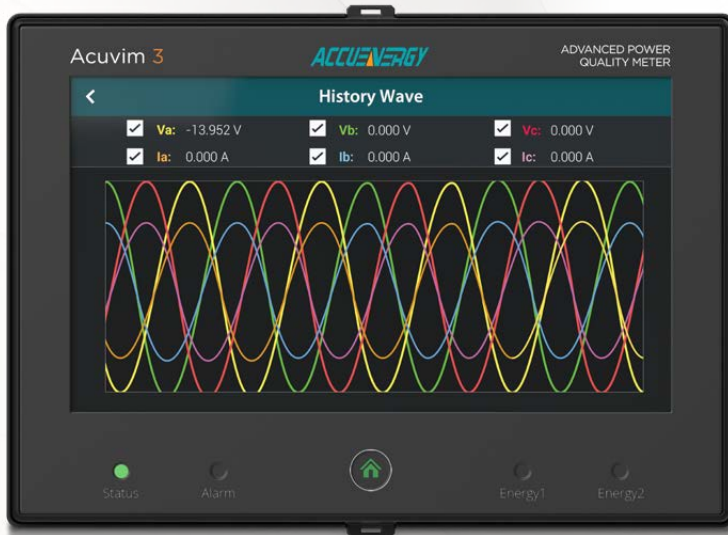

Advanced Power Quality Meter

The AcuVIM 3 Series is an advanced power quality and revenue grade meter. IEC 61000-4-30 Class A certified by third-party NMI for PQ. High accuracy ANSI C12.20 Class 0.1/IEC 61557-12 Class 0.1 rated. Optional 7-inch touchscreen display unit can be install in a panel or DIN rail mounted. Multi-protocol industrial communication support for IEC 61850, EtherNet/IP, Modbus, BACnet, and more.

ACCUENERGY.COM/ACUVIM-3



EN55011



Key Specifications

- IEC 61000-4-30 Class A compliant PQ analyzer
- PMU (IEEE C37.118) for fast and reliable synchrophasor measurement
- ANSI C12.20 Class 0.1 Accuracy / IEC 62053-22 Class 0.1S active energy and IEC 62053-24 Class 0.5S reactive energy
- TOU with 8 tariff and up to 12 billing periods
- Multiple dataloggers with user-selectable logging interval and parameters
- 32 GB onboard memory for data logging and historical trend analysis
- Power quality event detection on half-cycle RMS to trigger email notification, or DO/RO
- Meter sampling rate at 1024 samples/cycle
- Waveform Capture detection up to 512 samples/cycle and stored in COMTRADE or CSV file
- Fast log report, download from webpage/SFTP, or post via HTTP(S), FTP, SFTP
- Reporting EN50160 compliance report, IEEE 519 compliance report, ITIC (CBEMA) Curve, SEMI Curve with AcuCloud
- Flicker & transient measurement and logging

**Selected models only*

PRODUCT COMPATIBILITY



ACUPANEL
COMPATIBLE
METER



Power Quality Analyzer

Identify power system anomalies in critical infrastructure. Common voltage sags & swells on half-cycle RMS, and transient overvoltage at 32 ksps. Detect harmonic distortions caused by non-linear loads, and frequency variation deviations.

Datalogger Fast Log

Measure and log energy, demand, RMS, power, fundamental, THD, phase angle, unbalance parameters. Configure multiple data loggers with user-selectable file length, parameters, and logging interval. Recording interval up to 200ms to 7 days depending on parameter.

Waveform Capture

Detect waveform for both voltage & current power quality events up to 512 samples per cycle. Capture pre and post-trigger events up to 360 cycles. Set up PQ trigger conditions for email alert integration and save as COMTRADE files for transfer to a remote server via HTTP/FTP for analysis.

PQ Compliant Reports

Power quality compliance reports based on EN50160 for standard PQ characteristics, and IEEE 519 pass/fail report for voltage/current harmonic distortion. ITC/CBEMBA and SEMI curve analysis for for IT equipment power tolerance.

PMU Synchrophaser

High precision, real-time measurements of voltage, current, phase angle and frequency across power distribution systems. Detects abnormal PQ events over a wide area grid for early warning alerts.

Revenue Grade

ANSI C12.20/IEC 62053-22 Class 0.1S accuracy with four-quadrant active energy monitoring for critical applications that rely on consistent, high-accuracy readings. Voltage/current half-cycle RMS, and frequency accuracy at 1 mHz, 40 to 70 Hz.

Industrial Communication Protocols

Multi-protocol support for a wide range of industry-standard protocols.

- PMU (Synchrophasor)
- Modbus-RTU via RS485
- BACnet-IP via RS485
- Dual Ethernet
- Wi-Fi
- Modbus-TCP/IP
- HTTPS Webserver
- HTTP/HTTPS Post



- IEC 61850
- EtherNet/IP
- FTP/sFTP Post
- SMTP
- SNMP
- SNTF
- DNP3 over IP



I/O Module Options

	AXM-IO1	AXM-IO2	AXM-IO3
Digital Input	6	4	4
Digital Output	-	2	-
Relay Output	2	-	2
Analog Inputs	-	-	2
Analog Outputs	-	2	-



ACUVIM II



Advanced Multi-Function Power & Energy Meter Series

The Acuvim II series energy submeters are the simple, robust solution for power monitoring, power quality analysis, kW metering, and more. Designed for easy integration in almost any metering application, a wide array of plug-in expansion modules allows communication on over 15 different industry-standard protocols.

ACCUENERGY.COM/ACUVIM-II



Key Specifications

- NEW** Acuvim IIW with IEC 6100-4-30 Class S for PQ event, waveform, aggregation data
- NEW** ITIC Curve for recording voltage sags and voltage swells with its duration
- Revenue grade ANSI C12.20 Class 0.1 & IEC 62053-22 Class 0.1s
- Built-in Modbus-RTU and BACnet-MS/TP via RS485 port
- Expand with dual RJ45, WiFi, Fiber optic, Profibus and more interfaces
- Add up to three expansion communications & I/O modules
- MV90 compatibility

- Datalogging with up to 1-second interval, max/min/average, and instantaneous reading*
- COMTRADE Waveform file format*
- Threshold alarms can be set to notify users of potential issues
- Time-of-Use (TOU) capability allows time-based or tier-based rate structure*
- Support Modbus, BACnet, IEC 61850, EtherNet/IP, IPv6, RSTP, SNMP, HTTPS, sFTP, MQTT & other protocols
- Cloud metering data storage & analytics

**Selected models only*

PRODUCT COMPATIBILITY

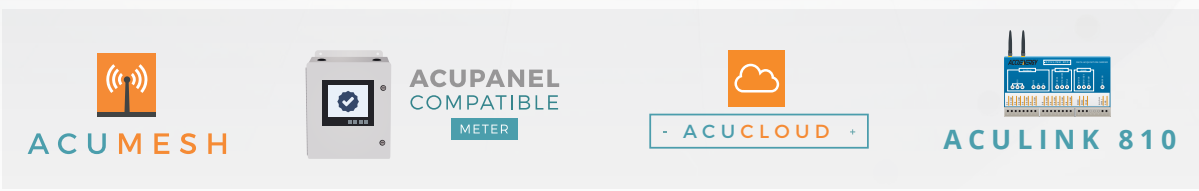

Data Logging

Essential to trend analysis and reporting, the Acuvim IIR and IIW offer a robust data logging feature where most metering parameters can be recorded for later review. The integrated real-time clock ensures logged events are accurately time stamped. Non-volatile memory is built into the meter and, by equipping the AXM-WEB2 module, an additional 8GB of memory with up to a 1-second logging interval is made available.

Anti-Tampering Seal

Much like a utility meter, the Acuvim II can be physically sealed to protect against tampering. All metrological programming and user-defined parameters are safeguarded with the physical seal.

Alarms

Quickly set over or under limit alarms for up to 16 indicated parameters with a specified time interval. If a parameter goes outside its setting limit, the alarm output is triggered, and the event is recorded with a time and date stamp for later analysis. Easy to manage and customize, the alarm can be configured using any of 80 available parameters.

Power Quality Monitoring

Power quality monitoring ensures systems run at maximum efficiency. The Acuvim IIW can detect energy deviations using harmonic analysis, event logging, and waveform capture. Facility managers can use the detailed PQ data to diagnose power quality issues before they result in system inefficiency.

Waveform Capture

The Acuvim IIW can record 100 groups of voltage and current waveforms. The instrument supports a settable triggering condition and provides a waveform record of 10 cycles before and after each triggering point. Data can be stored in the COMTRADE waveform file format for later analysis.

Time-Of-Use

Time-based tariffs can lead to higher power bills when energy-intensive devices are run during peak hours. Time-of-use metering allows facility managers to reduce energy costs where TOU rates have been applied. Gain valuable insight into a facility's load profile with built-in peak analysis tools.

AXM-DIN Rail Mounting Adapter

The AXM-DIN Rail Adapter is the easy solution for panel-mount Acuvim II series meters on either horizontal or vertical DIN rail.



IP66/NEMA4X Adapter Protection Cover

Defend against dust, water, or other contaminants: The Protection Cover is designed for all Acuvim II panel meters. It increases the IP environmental rating of a meter's display to IP66 or NEMA 4X.



Acuvim II Series Models

	Acuvim IIR	Acuvim IIW
Application	Billing / Data Logging	Power Quality
Metering	400 Parameters	400 Parameters
Data Log Onboard Memory	16MB	16MB
With AXM-WEB2 Data Log	8GB	8GB
Time-of-Use	•	•
Power Quality		•



EXPANSION MODULES

Snap-On Communication Modules for Acuvim II Series Meters



Acuvim II Communication Modules

The AXM modules are designed to expand the communication capabilities of the Acuvim II meter. Easy to deploy, the field-expandable modules connect directly to the meter to boost the number of compatible communication protocols or increase the number of I/O ports.



ACCUENERGY.COM/AXM-MODULES

I/O Module Options

	AXM-IO1	AXM-IO2	AXM-IO3
Digital Input	6	4	4
Digital Output	-	2	-
Relay Output	2	-	2
Analog Inputs	-	-	2
Analog Outputs	-	2	-

Acuvim II AXM Expansion Modules

	Meter Only	AXM WEB2 FOLC	AXM WEB2	AXM WEB2-D	AXM WEB PUSH	AXM PROFI	AXM RS485
Modbus-RTU	•						•
BACnet-MS/TP	•						
DNP 3.0 Over IP		•	•	•	•		
IEC 61850		•	•	•			
Modbus-TCP/IP		•	•	•	•		
HTTP/HTTPs Webserver		•	•	•	•		
SMTP Email		•	•	•	•		
SNMP V3		•	•	•	•		
MQTT		•	•	•			
EtherNet/IP, RSTP, IPv6		•	•	•			
HTTP/HTTPs Push		•	•	•	•		
FTP Post		•	•	•	•		
sFTP Server		•	•	•	•		
Datalogging	16MB	8GB	8GB	8GB	4GB		
BACnet-IP		•	•	•			
PROFIBUS						•	
WiFi		•	•				
RJ45 Ports		1	2	2	1		
Fiber Optics LC		•					



ACUVIM II +

AXM-WEB2 • **AXM-WEB2-D** • **AXM-WEB2 FOLC**

WiFi + Dual Ethernet Dual Ethernet WiFi + Ethernet + Fiber Optics LC

ACCUENERGY.COM/AXM-WEB2

ACCUENERGY.COM/AXM-WEB2-D

ACCUENERGY.COM/AXM-WEB2-FOLC



Key Specifications

- Graphical display for easy analysis
- Metered data is backed up in 8GB non-volatile memory
- RJ45 daisy chain using dual Ethernet ports
- Maintain high availability with RSTP
- Industry-leading 40ms response rates via Modbus TCP/IP
- Custom Modbus register list groups key parameters
- Compliant with industry-standard security protocols
- IPV6 & IPV4 dual IP network support
- Over-the-air (OTA) firmware updates
- Easy integration with Allen Bradley & Rockwell systems

WEB2 Interface Provides Remote Access

Take full control of the Acuvim II power meter through the web browser interface. Access complete energy from anywhere in the world. Manage and update meter configuration settings including 16 over/under alarm settings. Two-tier user control settings ensure reliable access without compromising meter security.

IEC 61850 Certification

The Acuvim IIW power meter with AXM-WEB2 Series communication module has been 3rd party certified to meet stringent IEC 61850 (2nd ed.) requirements for seamless deployment in substations and other critical facilities.

Flexible Communication Support

Designed to securely meet a wide range of industrial communication requirements, each module is equipped with both Ethernet and WiFi channels. Additionally, the AXM-WEB2 FOLC includes a fiber optic LC port for fast, reliable signal transmission. Communication ports can be utilized simultaneously across different networks or data acquisition systems.

Data Logging & Event Storage

The AXM-WEB2 Series module expands the meter's memory to an industry-leading 8GB with 1-second interval datalogging. Most metering parameters can be recorded for later download or analysis.



Datalogging and Event Storage



WPA2 Enterprise security protocol



Access anywhere via SerialNumber.accuenergy.io



COMtrade Waveform Format



Daisy-chain support via Ethernet ports,



ACUVIM L



Standard Multifunction Power & Energy Meter Series

The Acuvim L is a cost-effective power meter that offers performance and value for standard metering solutions. Designed to be easily integrated in panels, as a DIN rail transducer, or as a pre-wired panel. Ideal for a variety of different industrial & commercial applications.

ACCUENERGY.COM/ACUVIM-L



Key Specifications

- Model EL: ANSI C12.20 class 0.2 & IEC 62053-22 class 0.2s revenue grade accuracy
- Model CL: ANSI C12.20 class 0.5 & IEC 62053-22 class 0.5s revenue grade accuracy
- 4th CT input – measure neutral current
- Dual Ethernet ports with both RSTP bridge daisy-chain mode and separately configurable network
- Remote channel mapping and four channel multi-circuit metering
- Dual source meter to monitor energy usage from separate energy sources
- Data Logging available in 16MB onboard and 8GB with WEB2 module
- Designed with industry leading cybersecurity
- Available compatibility with multiple CT output options including 5A, RCT (Rogowski), or 333mV
- Modbus-RTU & BACnet MS/ TP ready. Optional modules add support for multiple industrial protocols & interfaces such as Modbus- TCP/IP, BACnet-IP, and WiFi

** Selected models only.*

PRODUCT COMPATIBILITY

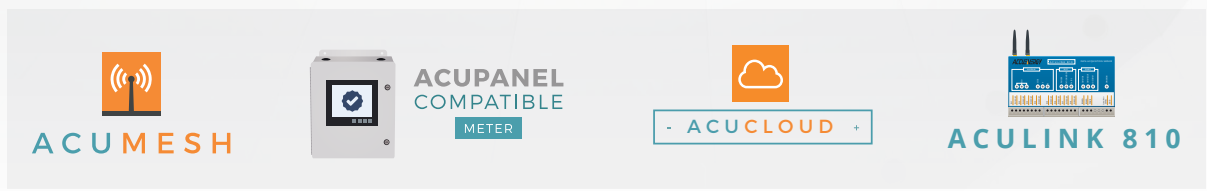

Modbus, BACnet with PROFIBUS Option

The Acuvim L meters are equipped with Modbus-RTU & BACnet-MS/TP protocol, allowing for interoperability between devices that utilize serial communication.

Through an expansion module, add optional PROFIBUS protocol ideal for factory automation systems.

Data Logging

Acuvim L meters offer three, assignable historical logs and a real time clock to record metering parameters with accurate timestamping. Add the AXM-WEB2 module to expand the memory to 8GB with an adjustable log size.

Time-of-Use (TOU)

Users can assign up to four tariffs (sharp, peak, valley, & normal) to different time periods within a day, as well 12 seasons, and 14 schedules. The Acuvim L meter will calculate and accumulate energy to different tariffs according to the meter's internal clock and TOU settings.

Alarms

Limits can be set for up to 16 indicated parameters with a specified time interval. Parameters that are over or under setting limit and persist longer than the specified time interval will be recorded and trigger the Alarm DO. Choose from 80 available parameters.

AXM-DIN Rail Mounting Adapter

The AXM-DIN Rail Adapter is the easy solution for panel-mount Acuvim L series meters on either horizontal or vertical DIN rail.



IP66/NEMA4X Adapter Protection Cover

The protection cover is designed to defend against dust, water, or other contaminants. It increases the IP environmental rating of a meter's display.



Communication Module Comparison

	Meter Only	AXM WEB2 FOLC	AXM WEB2	AXM WEB2-D	AXM PROFI	AXM RS485
Modbus-RTU	•					•
BACnet-MS/TP	•					
DNP 3.0 Over IP		•	•	•		
IEC 61850		•	•	•		
Modbus-TCP/IP		•	•	•		
HTTP/HTTPs Webserver		•	•	•		
SMTP Email		•	•	•		
SNMP V3		•	•	•		
EtherNet/IP		•	•	•		
MQTT		•	•	•		
RSTP		•	•	•		
IPv6		•	•	•		
HTTP/HTTPs Push		•	•	•		
FTP Post		•	•	•		
sFTP Server		•	•	•		
Datalogging	16MB	8GB	8GB	8GB		
BACnet-IP		•	•	•		
PROFIBUS					•	
WiFi		•	•			
RJ45 Ports		1	2	2		
Fiber Optics LC		•				

Acuvim L Series Models

	CL	EL
Metering	Voltage (V), Current (Amp), Power (kW)	Voltage (V), Current (Amp), Power (kW)
Energy & Demand	•	•
Time-of-use	•	•
Accuracy	0.5%	0.2%
Power Quality Individual Harmonics	2 nd to 31 st	2 nd to 63 rd



ACUREV 1310



DIN-Rail Digital Panel Meter

The AcuRev 1310 combines reliable performance with easy integration to provide a cost-effective power and energy monitoring solution for three-phase AC systems. It's robust design features a built-in LCD, Modbus-RTU communications, and 4 current input channels.

ACCUENERGY.COM/ACUREV-1310



Key Specifications

- Utility revenue grade accuracy - IEC 62053-22 0.5s Class / ANSI C12.20 0.5 Class
- Measurement Canada approved
- Compatible with a variety of CT options: 5A/1A, 333mV, Flexible Rogowski Coil, and 80/100/200mA
- 4 Channel current input including neutral current measurement
- Residual current measurement available
- 10-690Vac direct voltage input; fits all voltage rating system with one model
- Integrated RS485 port with Modbus-RTU and BACnet MS/TP for communication with most systems.
- Standard DIN-rail mount for ease-of-installation
- Compatible with both 50Hz and 60Hz systems
- Built-in energy pulse output and alarm output
- Optional relay output for alarm and remote control

PRODUCT COMPATIBILITY



4 Channel CT Input

Accurately measure neutral current with 4th CT channel to provide residual current measurement.

Auto Phase-Check

Designed to automatically check most common wiring mistakes including CT orientation, as well as voltage and current phase alignment.

Supports All Electrical Systems

Monitor a variety of electrical systems including three-phase three wire (3P3W), three-phase four-wire (3P4W), single-phase three-wire (1P3W two element), single-phase two-wire (1P2W one element), and more.

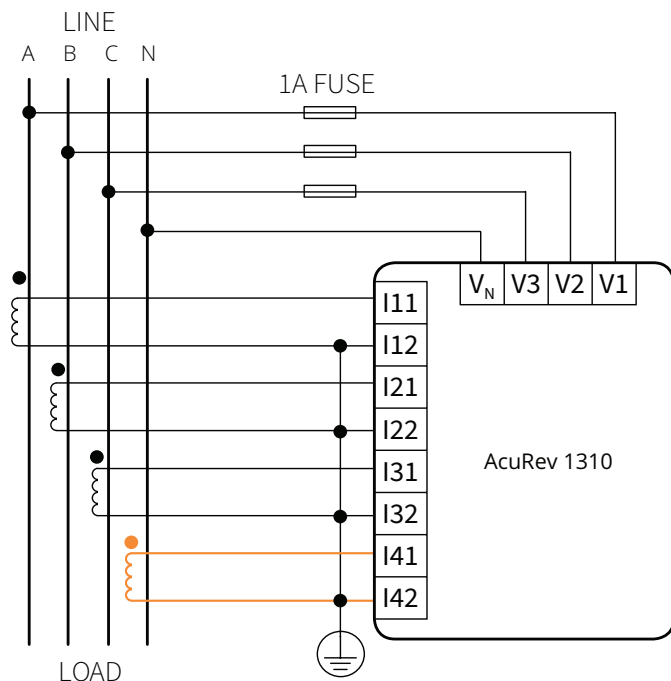

NEMA 4X Rated Wall Mount Enclosure For AcuRev 1310 Series

The AcuRev 1310 enclosure (AcuRev 1310-ENC) offers a mounting option for AcuRev1310 Series energy meters that helps protect from tampering and the elements.



AcuRev 1310 Series Models

	1312	1313	1314
Application	DIN-Rail mounted real-time power and energy monitoring	DIN-Rail mounted real-time bi-directional power and energy monitoring	DIN-Rail mounted real-time multifunction monitoring with neutral current measurement and calculated residual current
Metering	Energy, Time-of-Use, Power Demand, Current Demand, Voltage, Current, Power, Power Factor, Frequency	Energy, Time-of-Use, Power Demand, Current Demand, Voltage, Current, Power, Power Factor, Frequency	Energy, Time-of-Use, Power Demand, Current Demand, Voltage, Current, Power, Power Factor, Frequency
Current Input	5A/1A: Field-Configurable 5A or 1A Current Transformer Input 333mV: 333mV Current Transformer Input RCT: Flexible Rogowski Coil Current Transformer Input 80/100/200mA: Field Configurable 80mA, 100mA or 200mA Current Transformer Input		
I/O Options	One relay output for alarm and remote control		

AcuRev 2100

Multi-Circuit Submeter with SnapOn CT Technology

Monitor Multiple Circuits with SnapOn CT Technology. The AcuRev 2100 is the next-generation multi-circuit power and energy meter designed to measure 18 single-phase circuits using SnapOn CT technology for quick and easy installations in high-density, multi-point applications. Reliably monitor real-time energy consumption and power quality in commercial, residential, and industrial multi-tenant energy management systems.



ACCUENERGY.COM/ACUREV-2100



Key Specifications

- 18 single-phase or 6 (or 9) polyphase circuits
- Measurement Canada approved revenue-grade (ANSI C12.2 Class 0.5 & IEC 62053-22 Class 0.5s)
- Advanced power quality analysis
- Built-in WEB2 module meets all communication protocol needs
- Modbus, BACnet, SMTP, HTTP/HTTPS Post, FTP & NTP, SFTP, SNMPv3, and RSTP
- WiFi communication channel, with IPv6
- Remote meter access via SerialNumber.accuenergy.io
- Dual Ethernet ports for unparalleled communication and daisy-chain connection
- Secure and encrypted HTTPS web server for meter reading and configuration
- 8GB onboard memory for data logging and historical trend analysis
- Programming and terminal tamper-proof seal
- 18 Digital Inputs for water and gas metering
- 6 Digital Outputs, 2 Relay Outputs
- Optional cloud-based data storage with AcuCloud

PRODUCT COMPATIBILITY



ACUPANEL
COMPATIBLE
METER



SnapOn CT Technology

Accuenergy has designed an innovative CT technology that allows any 80mA, 100mA, or 333mV current transformer to plug into the AcuRev 2100 submeter without the use of traditional terminal blocks or error prone wiring configuration. Simply attach the SnapOn connector to a CT and plug into the meter for a fast, convenient installation experience. 20 SnapOn CT connectors are included with the meter.

Measurement Canada Approved

The AcuRev 2100 is approved to meet stringent Measurement Canada specifications and ANSI C12.20 Class 0.5 and IEC 62053-22 Class 0.5s accuracy requirements. Terminal sealing provides added security, prevents tampering with metering settings, and safeguards data integrity.

Over/Under Limit Alarms

Ten limit alarms can be assigned to various conditions. The alarm function effectively alerts and protects systems by sending out notifications and automatically shutting down equipment. Alarms can be configured for peak demand, current, or power quality thresholds. Use the web interface to view active and historical alarms, as well as configure new alarms.

WEB2

The built-in WEB2 module provides remote access to real-time energy data monitoring. View details on power & energy, power quality, and other critical measurements. A wide range of communication methods are supported including dual Ethernet & WiFi. Additionally, it provides compatibility with an array of industrial protocols including Modbus TCP/IP, BACnet IP, MQTT, SMTP, HTTP/ HTTPs Post, and more.

Power Quality Analysis

Power quality analysis is essential in industrial & commercial applications where protecting sensitive electronic equipment is critical. AcuRev 2100 series meters provide power quality parameters such as voltage and current THD, individual voltage and current harmonics up to the 31st order, voltage crest factor, current K factor, and voltage and current unbalance. These parameters are monitored in real-time and logged in memory.

Data Logging

Real-time energy metering, power quality analysis, and I/O data can be stored in the onboard, non-volatile memory. Logged information can be retrieved via serial connection or remotely by Ethernet in Excel, CSV, or text format for historical trending and system analysis. The ample internal memory provides over 100 years of the memory if the meter is configured to monitor 100 energy parameters at 5-minute intervals.

IP66/67 Rated Wall Mount Enclosure

The AcuRev 2100 enclosure (ENC-12127PIP67) offers a mounting option for AcuRev 2100 Series energy meters that helps protect from tampering and the elements.



AcuRev 2100 Series Models

AcuRev 2110	
Application	Multi-Tenant & High-Density Submetering
Number of Single Phase Circuits Monitored	18
Number of Three Phase Circuits Monitored	6
CT Input	80mA, 100mA, 333mV, Rogowski Coil
Communication	RS485, Dual RJ45, WiFi





AcuDC 240



DC Energy Meter

The AcuDC 240 series of DC power and energy meters is designed to monitor DC consumption and generation in renewable energy, transportation, telecommunication, and more. The AcuDC 240 is an effective metering device able to read voltage, current, power, energy and ampere-hour. The latest model comes with basic capabilities to monitor EV charging stations.

ACCUENERGY.COM/ACUDC-240



Key Specifications

- NEW** High-accuracy model provides basic monitoring for EV charging stations.
- NEW** Cable loss compensation for current, voltage, energy and power measurement.
- NEW** Compatible with DC shunts with 0.1% - 0.5% accuracy, ranging from 50A to 2000A input.
 - 0.2% accuracy for voltage and current, 0.5% accuracy for power and energy.
 - Modbus-RTU communications.
 - Monitor and control power switches.

- Standard 72x72mm size allows for drawer-type panel installation.
- Accessible with SCADA, PLC systems.
- Onboard data logging of all DC metering parameters for analysis.
- Compatible with Hall effect sensor power supply (+/- 15Vdc) for ease-of-measuring.
- Optional digital input and output, analog and relay output I/O expansions.

PRODUCT COMPATIBILITY

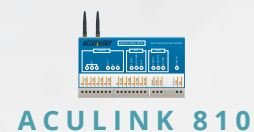

Electric Vehicle Charging Stations

AcuDC 240 provides basic real-time monitoring of energy consumption in EV charging stations with revenue-grade accuracy, providing reliable insights through accumulated totals and historical data logs. Compatible with Accuenergy DC shunts with various input options, offering precise tracking of 0.1 - 0.5% accuracy level.

Solar Arrays

Directly monitor the power and energy produced from the solar array, before the inverter, for the most accurate analysis of solar production.

Wind Turbines

Meter the production and effectiveness of wind generated energy before its sent into the grid and integrate with existing systems through Modbus-RTU.

Cable Loss Compesation

Adjusting for power losses due to cable resistance, ensuring accurate and reliable monitoring. Essential for applications requiring high accuracy, mitigating the losses over long cable runs.

Expansion Modules

Compatible with expansion modules offering additional analog, digital, and relay inputs and outputs. Certain modules also feature a Hall effect sensor power supply for additional flexibility.

AcuDC 240 Series Din Rail Mounting Adapter

AcuDC 240 Series DIN Rail adapter (DC-DIN) provides an easy installation for all panel-mounted AcuDC 240 meter models and I/O options that require a DIN rail solution.

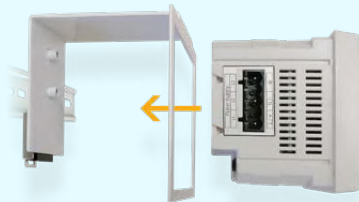

AcuDC 240 Series Models

Function	AcuDC 243
Application	All DC Monitoring & Metering Applications
Metering Parameters	Voltage, Current, Power, Energy, Ampere-Hour
I/O Modules Available	•
Data Logging	Optional
Communication Protocol	Modbus-RTU

AcuDC 240X Expansion Modules

	Digital Input (DI)	Analog Output (AO)	Analog Input (AI)	Relay Output (RO)	Digital Output (DO)	Hall Effect Sensor Power Supply
X1	2	2 (4-20mA / 0-20mA)				
X2	2	2 (0~5V / 1~5V)				
X3	2			2		
X4	2				2	
X5	2					+/-15Vdc



AcuDC 300



EV Charging Meter

The AcuDC 300 is designed to be integrated with EV fast charging infrastructures to meter the energy supplied to electric vehicles. Compliant to IEC 62053-41:2021 Class 0.5 & EN50470-4 Class C standards, it ensures revenue-grade performance for measurement and billing applications. Featuring cable loss compensation along with a measurement accuracy of 0.2% on current and 0.1% on voltage between 60V to 1000V.

NEW PRODUCT

ACUENERGY.COM/ACUDC-300



Key Specifications

- IEC 62053-41:2021 Class 0.5 & EN50470-4 Class C compliant bi-directional energy measurement.
- 0.1% (60V-1000V) accuracy, direct connected voltage measurement.
- 0.2% (\pm 650A) accuracy, bi-directional current measurement.
- Modbus-RTU/Modbus-TCP/IP for data query & configuration over RS485/Ethernet.
- Cable loss compensation for billing accuracy, no overcharged.
- MID certified & UL recognized.
- Signed data readouts in OCMF format.
- 3 data loggers & 1 trend logger with non-volatile memory.
- Real-time data query & configuration via HMI display.
- Electronic metrology seal and two seal tabs for tamper-evident seals.

PRODUCT COMPATIBILITY



ACUMESH



ACUCLOUD

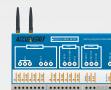

ACULINK 810

DC Fast Charging

With a compact enclosure designed for 35mm DIN rail mount and IEC 62053-41:2021 Class 0.5, EN50470-4 Class C compliant measurement accuracy, the AcuDC 300 is an ideal solution for EV charging stations where precise billing is required. Its $\pm 650\text{A}$ current input and 0-1000V voltage input also enables support for most DC fast charging stations.

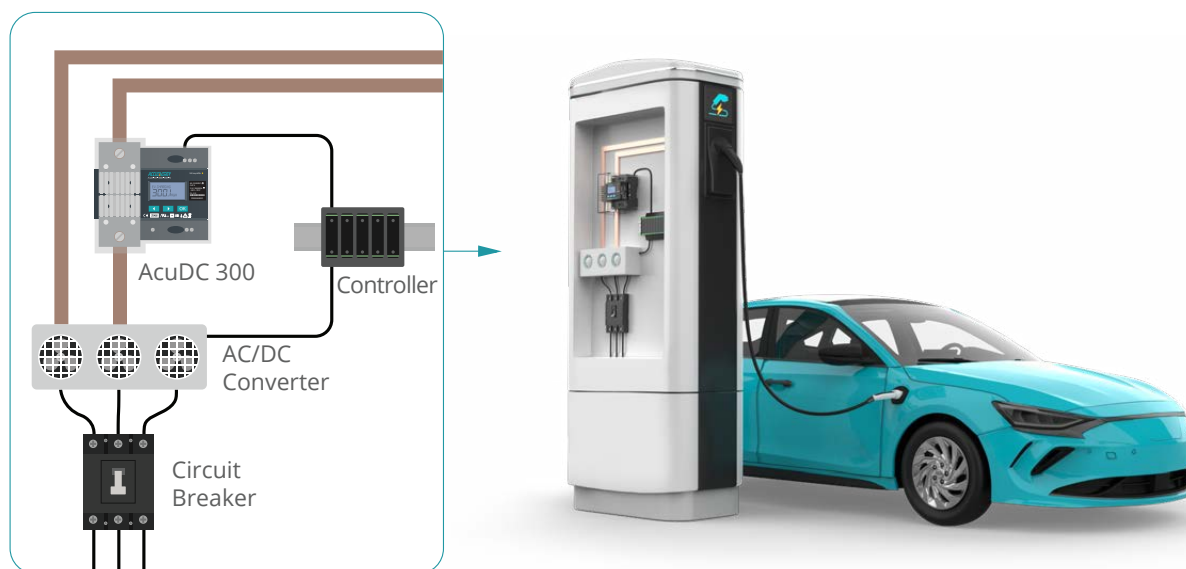

Cable Loss Compensation

Resistance in the charging cables may lead to energy loss dissipated as heat, causing the energy received by the EV to be lower than the energy delivered from the charging station. AcuDC 300 ensures fair billing with cable loss compensation and make sure the user is only charged for the energy received.

Anti-Tampering Metrology Seal

AcuDC 300 features an anti-tampering design with an electronic seal switch that can be toggled on or off. When enabled, certain critical settings are locked and cannot be modified. The seal switch is only accessible by removing the protective front casing, which can be secured with tamper-evident seals to increase the DC meter security.

OCMF Data Format

OCMF (Open Charge Metering Format) is a widely used data format developed for exchanging data between EV charging infrastructures and billing systems, promoting transparency and interoperability across the industry. AcuDC 300 supports the OCMF format to ensure safe and trusted communication between devices.

AcuDC 300 Models

Function	AcuDC 301
Application	EV Fast Charging Stations
Metering Parameters	Voltage, Current, Power, Energy, Charge, Ripple Factor, Demand
Data Logging	3 Data Loggers & 1 Trend Logger
Communication	Modbus-RTU via RS485, Modbus-TCP/IP via Ethernet
Current Input	$\pm 650\text{A}$, 0.2%
Voltage Input	0-1000V, 0.1% (60-1000V)



UL 508A Panel Shop

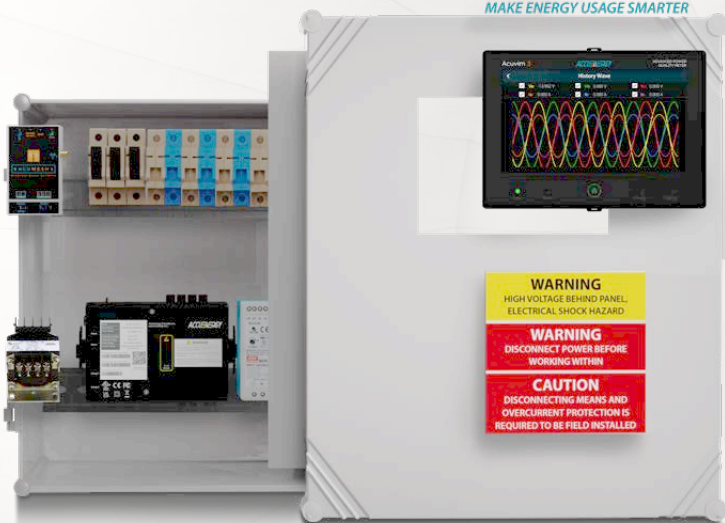

Custom Industrial Control Panel Solutions

Our UL 508A panel shop solutions can be customized by specifying communication devices, branding, panel size, cut-out locations, and more to create a unique solution for your application while maintaining the UL certification for the entire panel. All custom builds undergo rigorous testing to guarantee reliability and performance. Every panel we assemble carries UL/cUL certification, the highest safety standard, eliminating the need for local inspection and saving both installation time and cost.

ACCUENERGY.COM/PANEL-SHOP



Key Specifications

- Every panel meets rigorous UL/cUL standards
- Required components are pre-installed, pre-wired, and clearly labeled
- The plug-and-play design saves valuable installation time
- Wiring and installation errors are virtually eliminated
- The panel is self-powered and does not require a separate power supply
- Available panel materials: NEMA 3-rated steel panel for indoor applications or NEMA 4X-rated for outdoor conditions

PRODUCT COMPATIBILITY

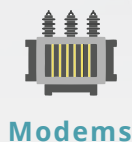
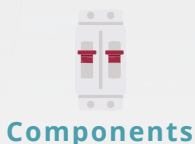

Certified UL 508A Panel Shop

As a certified UL 508A panel shop manufacturer, Accuenergy carefully designs each panel to high industry standards, delivering superior safety, compliance, and quality.

Our panels are engineered with precision to provide reliability, making them ideal for a variety of applications, both indoors and outdoors.

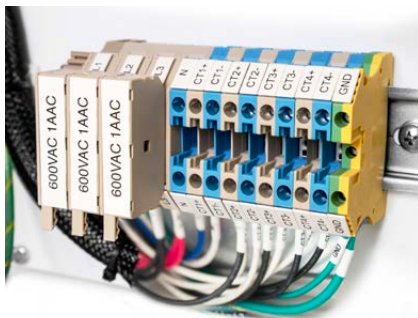

Factory Wiring and Components

Featuring reliable, factory-tested wiring with clear labels, all custom panels are factory-assembled, with the components color-coded and labeled to ensure easy connection and quick installation.

UL 508A Panel Shop	
Compatible Meters	Any Accuenergy Meter
Application	Custom applications that require a unique panel configuration
Certifications	UL, cUL, UL 508A
NEMA Rating	NEMA 1 - NEMA 4X
Material	Steel or Polycarbonate
Anti-Corrosive	Polycarbonate Only
Dust-Proof	•
Suitable for Indoor Use	•
Suitable for Outdoor Use	Polycarbonate Only
Pre-Wired	•
Pre-Configured	•

NEMA-Rated Panels

All Accuenergy panel shop solutions are fully customizable to meet different NEMA ratings, from NEMA 1 to NEMA 4X, tailored to meet each customer's specific requirements. This flexibility ensures that our panels provide the appropriate level of protection and durability for any environments.



Custom Branding

Accuenergy provides high-resolution, custom-printed labels for control panels, from full-color logos and instructional placards. Printed on durable materials, which are fully customizable in color, size, and placement to align with customer's branding.



Custom-Cut Enclosure

With custom-drilled holes, our panel shops facilitates efficient and organized wiring routes, streamlines the installation process, and eliminates the need for further modifications.

Secure Solution

Lockable panel enclosures provide enhanced security against tampering, safeguarding enclosed metering equipment to ensure data integrity and extend the lifespan of critical devices, which is essential for maintaining the reliability of energy monitoring systems.





AcuPanel 9100 Series



Pre-Wired Metering Panels

Cut down on costly installation & avoid wiring error with these pre-configured and pre-installed panel metering systems. The AcuPanel series also feature some of Accuenergy's most powerful meters including the Acuvim 3, Acuvim II, Acuvim L, and AcuRev 2100 series, secured in a either a NEMA 4 or NEMA 4X enclosure for versatile installation options.

ACCUENERGY.COM/ACUPANEL



Key Specifications

- Factory pre-wired and tested for fast, reliable installation
- Factory pre-configuration eliminates meter programming on-site
- Required accessory components are all pre-installed
- Self-powered panel does not require separate power supply
- Durable enclosures provide high tolerance for external force with well protection
- Housed in either a NEMA 4 rated industrial steel enclosure, or NEMA 4X rated polycarbonate enclosure for either indoor or outdoor implementation
- Available metering options include the Acuvim 3, Acuvim II Series, Acuvim L Series, AcuDC 240, and AcuRev 2100.

PRODUCT COMPATIBILITY





Clean Factory Wiring

Factory installed connections and components have been diligently tested to be reliable and dependable for an error-free integration into your system.



Components Included

Pre-assembled shorting blocks for current transformers and fused terminal blocks for voltage connections are colour coded and clearly labeled to allow for time-saving maintenance and identification.

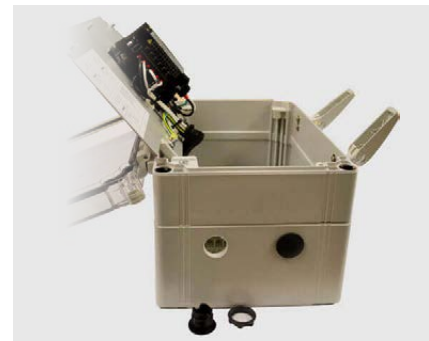

Pre-Cut Enclosure

Two pluggable, pre-cut holes allow wires to be securely fed through the enclosure without any added modifications to the enclosure. Simple grounding wire are firmly installed inside.

NEMA 4 Enclosure

Made from durable steel, this indoor rated enclosure provides a degree of protection against dirt, dust, and other solid objects.

NEMA 4X Enclosure

Rated for indoor and outdoor use, this NEMA 4X enclosure provides the ultimate shield against hostile environmental hazards including adverse weather & corrosion.

Standard pre-wired enclosure includes:

- Terminal blocks for current transformer input
- Shorting block for current transformer
- Terminals blocks for voltage input
- 3 Industrial-grade fuses



AcuPanel Series Models

	AcuPanel 9104	AcuPanel 9104X	AcuPanel 9104X-DC	AcuPanel 9106X	AcuPanel 9108X
	NEW PRODUCT				
Compatible Meters	Acuvm II, Acuvm L	Acuvm II, Acuvm L	AcuDC 240	AcuRev 2100	Acuvm 3
Application	Indoor installations that require rugged protection, but not weather resistance	Indoor or outdoor installations that require exceptional environmental protection and weather resistance			
NEMA Rating	NEMA 4	NEMA 4X	NEMA 4X	NEMA 4X	NEMA 4X
Material	Steel	Polycarbonate	Polycarbonate	Polycarbonate	Polycarbonate
Anti-Corrosive		•	•	•	•
Dust-Proof	•	•	•	•	•
Suitable for Indoor Use	•	•	•	•	•
Suitable for Outdoor Use		•	•	•	•
Pre-Wired	•	•	•	•	•
Pre-Configured	•	•	•	•	•

AcuLink 810

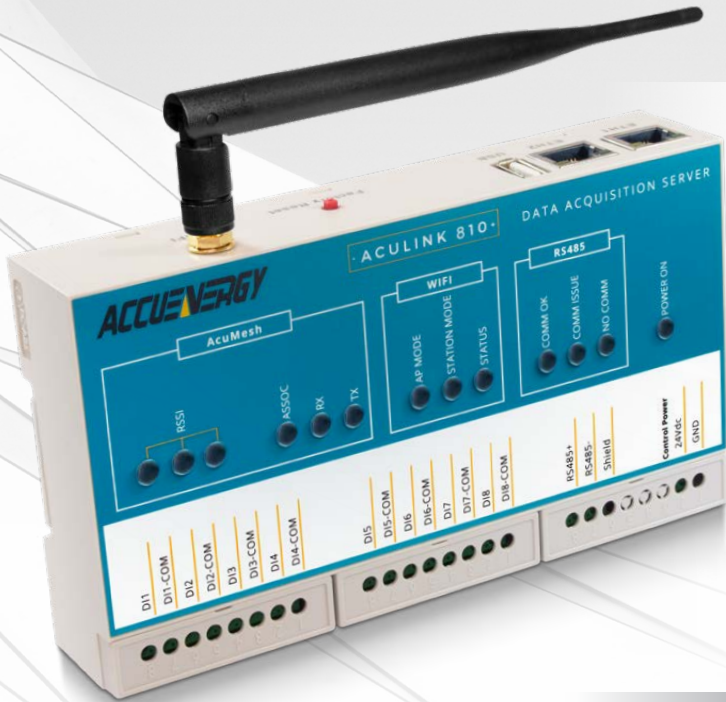

Data Acquisition Server & Gateway

Accuenergy's AcuLink 810 is a comprehensive DAQ BACnet gateway and server. Devices and metering data can be managed and accessed through a central hub before distributed to an energy management system. Energy data is available to be stored locally or transferred via an IP-based network to a remote server or controller.

ACCUENERGY.COM/ACULINK-810



Key Specifications

- Track energy usage, peak demand and other energy parameters
- BACnet-MS/TP data acquisition and logging with 8GB on-board memory
- BACnet gateway (Converts Modbus-RTU and BACnet-MS/TP to BACnet IP)
- Remote access to monitor and configure devices
- RSTP high availability to reduce network downtime
- Poll data from all RTU devices via Modbus-TCP/IP
- Ethernet Gateway for Modbus RS485 and Digital Output Devices
- Remote web-server access for real-time data and easy configurations
- Dual Ethernet RJ45 port and WiFi communication channels
- SSL and TLS1.2 compliant enhanced cybersecurity protection
- Over/Under alarm monitoring for connected devices

PRODUCT COMPATIBILITY



BACnet Gateway

AcuLink 810 can read Modbus, BACnet, and Mbus devices offering integrators the option to retrofit existing systems saving time and costs. Support for multiple protocols facilitates the intercommunication of devices by allowing such devices to interoperate on a BACnet IP network.

Data Logging

Critical data, such as energy and power quality measurements, is stored in 8GB non-volatile memory with a capacity for over three years of energy data collected at 15-minute intervals. Logged information is easily retrieved from a web browser or posted to a remote sever via HTTP/HTTPs, FTP in CSV or JSON format.

Embedded Web Server

Access and monitor all connected devices anytime, anywhere using a web browser. A friendly UI allows users to easily view of all collected devices with detailed real-time metering summary, setup, alarms, and configurable upload channels.

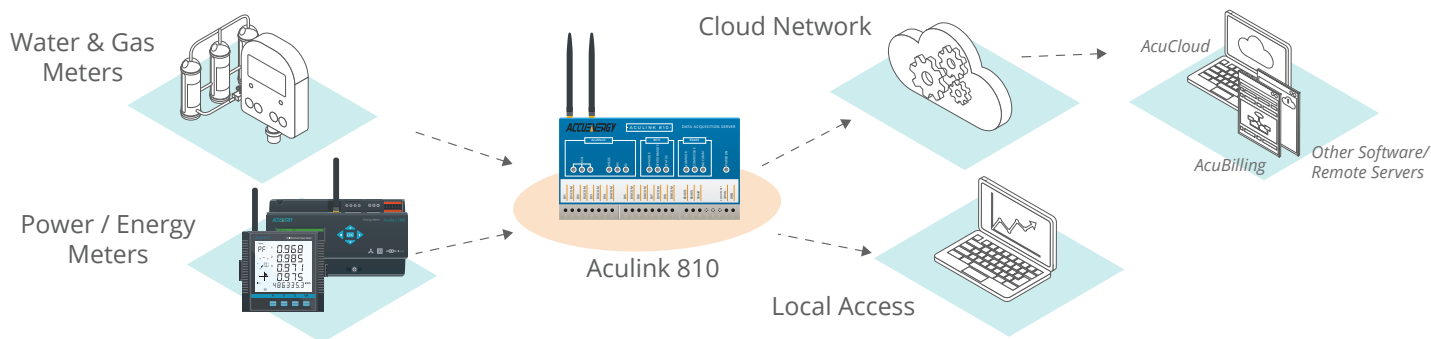

IoT Connectivity

Support for MQTT protocol allows subscribers to instantly receive up-to-date device data to their mobile phone or other Internet of Things devices. Messages can be configured to send at intervals for specific connected devices.

Poll Downstream Data

Allow a Modbus master on a remote network to poll downstream metering data directly from all RTU devices that are connected to the DAQ BACnet gateway. The AcuLink 810 supports Modbus polling for eight pulse counters used for water, heat, gas and electricity metering.

Daisy Chain 32 Devices

Users can daisy-chain multiple devices using the RSTP protocol. This can cut down the amount of network switches required in different applications and allows the use of 1 network switch/ router to be used with multiple devices. Multiple Modbus- RTU devices can be connected via USB port.

AcuLink 810 Gateway Conversion

	AcuLink 810-X	AcuLink 810-900	AcuLink 810-868
Gateway	Incoming Protocols	Modbus-RTU, Modbus-TCP/IP, BACnet-MS/TP, BACnet-IP, SunSpec, Mbus, Pulse Counter, Virtual Meter	
	Outgoing Protocols	Modbus-TCP/IP, BACnet-IP, SNMP, HTTP, HTTPs, FTP, sFTP, MQTT	
Digital Input		8 Pulse Counters	
Onboard Memory		8GB	
Interval Logging		1 to 1,440 Minutes	
AcuMesh 900Mz		●	
AcuMesh 868Mz		●	

AcuMesh



Wireless RS485 Transceiver

The AcuMesh network solution is designed to connect RS485-enabled devices including meters, sensors, gateways, PLCs, and more into a seamless wireless network. It offers a cost-effective, non-intrusive installation that eliminates the need for additional communications wiring.

ACCUENERGY.COM/ACUMESH

ROHS
COMPLIANT



Key Specifications

- Devices are connected automatically on power up without configuration or software
- Compatible with Modbus-RTU protocol
- Utilizes either the 900MHz or 868MHz frequency band available in most countries.
- Highly secure communication with 128-bit Advanced Encryption Standard (AES)
- Field-upgradable firmware
- Complex networks are easily configured using free software
- Communicate wirelessly between meters and other RS485 devices running any protocol within a building or campus
- Long-range communication: 1000 ft (305m) indoor / 4 Miles (6.5km) outdoor in a single hop

AcuMesh Wireless RS485 Network

The AcuMesh wireless RS485 network solution eliminates the need for physical RS485 communication wiring. Devices directly connect to an AcuMesh transceiver and the job is done. The AcuMesh transceiver transmits data and commands wirelessly within the network.



AcuCT Flex

Rogowski Coils

Designed for unmatched ease-of-installation, this specialized line of flexible AC current transformers is ideal for deployment in power metering, power quality, and general use applications where space is limited.

ACCUENERGY.COM/ACUCT-FLEX



Key Specifications

- 0.5% measurement accuracy & high linearity for demanding applications.
- Broad frequency range: 10Hz-20kHz. Excellent for harmonics and power quality. Higher frequency range available upon request.
- Four coil lengths available: 16", 24", 36", or 47".
- Wide current input range: 5A-50,000A AC. Higher current range available upon request.
- Directly compatible with Accuenergy RCT input devices - no external power supply or integrator needed.
- Multiple output ratio options available: 100mV/1000A, 40mV/1000A, 25mV/1000A, 10mV/1000A.

RCT GRIP Kit

The RCT GRIP Kit provides a secure mounting solution for AcuCT Flex, maintaining conductor alignment within the Rogowski coil's window to optimize accuracy and performance. Compatible with AcuCT Flex RCT 24, RCT 36, and RCT 47.



AcuCT Flex Series Options

	RCT16	RCT24	RCT36	RCT47
Input Range	5A - 50000A	5A - 50000A	5A - 50000A	5A - 50000A
Output Option	Output to Specified RCT input			
Window Size	4.17" (106mm)	7.01" (178mm)	10.67" (271mm)	14.53" (369mm)
Length	15.75" (400mm)	23.62" (600mm)	35.43" (900mm)	47.24" (1200mm)
Accuracy	0.5% Combined with Acuvim II Series at Any Point			
RCT GRIP Kit		RCT-GRIP-M	RCT-GRIP-L	RCT-GRIP-L



RIK Series

Rogowski Integrator

The integrators are a versatile, plug-and-play solution that allows Rogowski coils to be field-configurable for multiple CT input ratios. Single-phase and three-phase options are available.

ACCUENERGY.COM/ACUCT-RIK



Key Specifications

- CT ratios are field-configurable for on-site flexibility.
- Output types include 0-5A, 0-1A, 0-333mV, 4-20mA, 0-20mA, 0-5V, 0-10V
- RIK 1AR: 0-A Output Relay Class (5P20).
- Individual CT ratios can be configured for each channel.
- Works in any single-phase or three-phase applications.
- Works in both 50Hz and 60Hz systems.
- Four coil lengths available (sold separately).

RIK Series Options

	RIK 1AR*	RIK 5A	RIK mV*	RIK mA*	RIK V*
Current Measurement Range	0.25A - 100kA		2.5A - 60,000A		
Sensing Range	50A, 200A, 500A, 2000A and 5000A (User Selectable)	500A, 1000A, 2500A, 5000A, 10000A, 25000A and 50000A (Field Configurable)			
Output Rated Options	0-1A	0 – 6A RMS (0 – 5A RMS Nominal)	0-333mVac	4-20mAadc, 0-20mAadc	0-5Vdc, 0-10Vdc
Accuracy	% at 1A, 5% at 20A	1.0%	1.0%	1.0%	1.0%
Rogowski Coil Sizes	16", 24", 36", 47"				
Frequency	50Hz and 60Hz		45Hz to 65Hz		
Single-Phase	•	•	•	•	•
Three-Phase		•	•	•	•

*Rogowski coil and power supply sold separately.

AcuCT R

Revenue-Grade Split-Core CT



ACCUENERGY.COM/ACUCT-R

	AcuCT-075R	AcuCT-100R	AcuCT-125R	AcuCT-200R	AcuCT-3135R	AcuCT-4161R	AcuCT-5170R
Input Range	1A - 150A	5A - 250A	5A - 400A	5A - 1000A	5A - 1000A	5A - 5000A	5A - 5000A
Typical Input	50A, 100A, 150A	100A, 200A, 250A	100A, 200A, 300A, 400A	400A, 600A, 800A, 1000A	600A, 800A, 1000A, 1200A, 1500A	1200A, 1600A, 2000A, 2500A, 3000A, 4000A, 5000A	2000A, 3000A, 4000A, 5000A
Output Option	333mV, 80mA, 100mA, 200mA	1A, 333mV, 80mA, 100mA, 200mA	1A, 333mV, 80mA, 100mA, 200mA	1A, 333mV, 80mA, 100mA, 200mA	5A, 1A, 333mV, 80mA, 100mA, 200mA	5A, 1A, 333mV, 80mA, 100mA, 200mA	5A, 1A, 333mV, 80mA, 100mA, 200mA
Window Size	0.75" x 0.75" (19.5 x 19.5 mm)	1" x 1" (25 x 25 mm)	1.25" x 1.25" (32 x 32 mm)	2" x 2" (51 x 51 mm)	3.1" x 3.5" (80 x 90 mm)	4.1" x 6.1" (105 x 155 mm)	5.1" x 7" (130 x 180 mm)
Exterior Dimensions	2.3" x 2.3" x 0.9" (58 x 58 x 22 mm)	2.6" x 2.6" x 0.9" (65 x 65 x 22 mm)	3.2" x 3.2" x 0.9" (82 x 82 x 22 mm)	4.4" x 4.4" x 1.25" (111 x 111 x 32 mm)	5.7" x 6.1" x 1.25" (144 x 154 x 32 mm)	7.3" x 9.3" x 1.8" (185 x 235 x 45 mm)	8.3" x 10.2" x 1.8" (210 x 260 x 45 mm)
Accuracy	IEC 61869-2 Class 0.5						

AcuCT S

Solid-Core Current Transformer

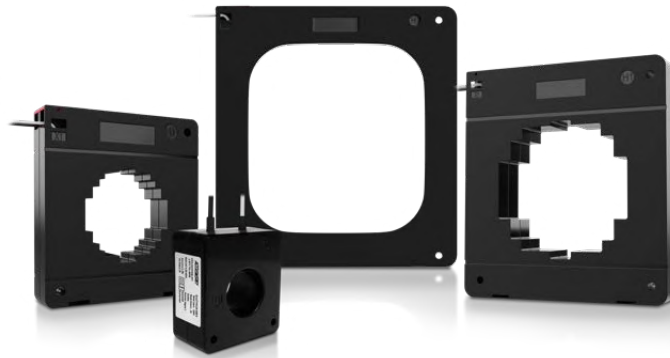

ACCUENERGY.COM/ACUCT-S

	AcuCT S77	AcuCT S113	AcuCT S220	AcuCT S335	AcuCT S433	AcuCT S650
Primary Input	100A, 200A	200A, 300A, 400A	200A, 250A, 300A, 500A, 600A, 800A, 1000A, 1200A, 1500A	500A, 600A, 800A, 1000A, 1200A, 1500A, 2000A, 2500A, 3000A	800A, 1000A, 1500A, 2000A, 2500A, 3000A, 3500A, 4000A	800A, 1000A, 1500A, 2000A, 2500A, 3000A, 3500A, 4000A
Rated Output	80mA, 100mA	1A, 5A, 333mV	5A, 1A, 100mA, 80mA, 333mV	5A, 1A, 100mA, 80mA, 333mV	5A, 1A, 100mA, 80mA, 333mV	5A, 1A, 100mA, 80mA, 333mV
Insulation Resistance	50 MΩ	<1,000V	500V/100MΩ min	500V/100MΩ min	500V/100MΩ min	500V/100MΩ min
Burden	B0.05/0.125VA	≤3.75VA	2.5-10VA	5-15VA	5-15VA	5-15VA
Exterior Dimension	2.00" x 0.75" (51.0 x 19.0mm)	2.38" x 2.68" x 0.96" (60.5 x 68.0 x 24.5mm)	4.53" x 4.92" x 1.26" (115.0 x 125.0 x 32.0mm)	5.75" x 6.14" x 1.26" (146.0 x 156.0 x 32.0mm)	6.50" x 6.89" x 1.38" (165.0 x 175.0 x 35.0mm)	8.66" x 9.06" x 1.38" (220.0 x 230.0 x 35.0mm)
Window Size	0.77" (19.6 mm)	1.20" (30.0 mm)	Ø 2.24" (57.0mm)	Ø 2.83" (72.0mm)	Ø 3.66" (93.0mm)	6.30" x 6.30" (160.0 x 160.0mm)



Current Transformers

AcuCT mV

333mV Split-Core CT



ACCUENERGY.COM/ACUCT-MV

	AcuCT-075	AcuCT-125	AcuCT-200	AcuCT-3050
Input Range	10A - 200A	30A - 600A	60A - 1500A	40A - 5000A
Typical Input	100A, 200A	300A, 400A, 600A	600A, 800A, 1000A, 1200A, 1500A	400A, 600A, 1000A, 1500A, 2000A, 3000A, 5000A
Rated Option	333mV			
Window Size	0.75" x 0.75" (19.1 x 19.1 mm)	1.25" x 1.25" (31.8 x 31.8 mm)	2" x 2" (50.8 x 50.8 mm)	3" x 5" (76.2 x 127 mm)
Exterior Dimensions	2" x 2.098" x 0.669" (50.8 x 53.3 x 17 mm)	3.248" x 3.35" x 1.025" (82.5 x 85.1 x 26 mm)	4.764" x 5" x 1.81" (121 x 127 x 30 mm)	5.748" x 7.5" x 1.402" (146 x 190.5 x 35.6 mm)
Accuracy	0.5%	0.5%	0.5%	0.5%

AcuCT Hinged

Compact Split-Core CT



ACCUENERGY.COM/ACUCT-HINGED

	AcuCT-H040	AcuCT-H063	AcuCT-H100	AcuCT-H138
Input Range	5A - 75A	5A - 150A	5A - 250A	10A - 630A
Typical Input	20A, 30A, 40A, 50A, 60A	50A, 100A, 150A	100A, 120A, 200A, 250A	200A, 400A, 600A
Rated Option	333mV			
Window Size	0.4" (10.2 mm)	0.63" (16 mm)	1" (25.4 mm)	1.38" (35 mm)
Exterior Dimensions	1.16" x 1.64" x 1.04" (29.4 x 41.7 x 26.4 mm)	1.42" x 2.09" x 1.2" (36 x 53 x 30.5 mm)	2" x 2.76" x 1.52" (50.8 x 70.1 x 38.6 mm)	2.56" x 3.27" x 1.57" (65 x 83 x 40 mm)
Accuracy	0.5%			

AcuCT 5A

5A Split-Core CT



ACCUENERGY.COM/ACUCT-5A

	AcuCT-0812	AcuCT-2031	AcuCT-3147	AcuCT-3163
Input Range	5A - 400A	5A - 1000A	5A - 1600A	5A - 5000A
Typical Input	100A, 150A, 200A, 250A, 300A, 400A	400A, 600A, 800A, 1000A	1000A, 1200A, 1600A	2000A, 2500A, 3000A, 4000A, 5000A
Output Option	5A, 1A	5A, 1A	5A, 1A	5A, 1A
Window Size	0.83" x 1.22" (21 x 31 mm)	1.97" x 3.15" (50 x 80 mm)	3.15" x 4.72" (80 x 120 mm)	3.15" x 6.3" (80 x 160 mm)
Exterior Dimensions	3.5" x 4.13" x 1.57" (89 x 105 x 40 mm)	3.5" x 4.13" x 1.57" (89 x 105 x 40 mm)	5.67" x 7.28" x 1.97" (144 x 185 x 50 mm)	6.93" x 9.72" x 2.76" (176 x 247 x 70 mm)
Accuracy	0.5%	0.5%	0.5%	0.5%

AcuCT C

Current Transformer Converter



ACCUENERGY.COM/ACUCT-C

	AcuCT C
Input Rating	5A
Rated Output	80mA, 100mA
Phase Error	< 8'
Accuracy	0.15
Exterior Dimension	2.11" x 3.10" x 1.20" (53.5mm x 78.5mm x 30.5mm)



DC Shunts

Shunt Series



[ACCUENERGY.COM/DC-SHUNTS](http://accuenergy.com/dc-shunts)

Shunt	50A	100A	200A	300A	400A	500A	600A	1000A	2000A
Voltage Drop	75mV	75mV	75mV	75mV	75mV	75mV	75mV	75mV	75mV
Primary Input	50A	100A	200A	300A	400A	500A	600A	1000A	2000A
Operation Temperature	-40°C to 80°C / -40°F to 176°F	-40°C to 80°C / -40°F to 176°F	-40°C to 80°C / -40°F to 176°F	-40°C to 80°C / -40°F to 176°F	-40°C to 80°C / -40°F to 176°F	-40°C to 80°C / -40°F to 176°F	-40°C to 80°C / -40°F to 176°F	-40°C to 80°C / -40°F to 176°F	-40°C to 80°C / -40°F to 176°F
Exterior Dimension	4.09" x 0.85" x 0.08" (104.0 x 21.5 x 2.0 mm)	4.09" x 0.85" x 0.08" (104.0 x 21.5 x 2.0 mm)	4.09" x 0.87" x 0.12" (104.0 x 22.0 x 3.0 mm)	4.72" x 1.77" x 0.16" (120.0 x 45.0 x 4.0 mm)	4.72" x 1.77" x 0.16" (120.0 x 45.0 x 4.0 mm)	4.72" x 1.77" x 0.16" (120.0 x 45.0 x 4.0 mm)	4.72" x 2.44" x 0.16" (120.0 x 62.0 x 4.0 mm)	4.92" x 2.76" x 0.83" (125.0 x 70.0 x 21.0 mm)	7.87" x 3.31" x 3.82" (200.0 x 84.0 x 97.0 mm)
Accuracy	0.1%	0.1%	0.1%	0.1%	0.1%	0.1%	0.1%	0.2%	0.5%



DC Sensors

Hall Effect DC Current Sensors

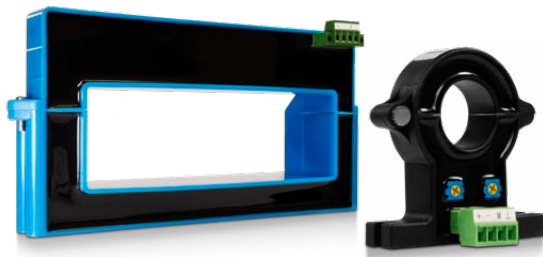

HV2

DC Voltage Sensor



[ACCUENERGY.COM/DC-SENSORS](http://accuenergy.com/dc-sensors)

[ACCUENERGY.COM/HV2](http://accuenergy.com/hv2)

	HAB 16555	HAK21	HAK40
Primary Input	1000A, 2000A, 3000A, 4000A, 5000A	50A, 100A, 200A	400A, 600A, 1000A
Rated Output	4-20mA, 0-5V	4-20mA, 0-5V	4-20mA, 0-5V
Window Size	6.50 x 2.17 (165 x 55mm)	0.83 (21mm)	1.58 (40mm)
Exterior Dimension	3.80" x 9.25" x 1.93" (96 x 235 x 49 mm)	2.36" x 2.40" x 0.63" (60 x 61 x 16 mm)	3.94" x 3.94" x 0.94" (100 x 100 x 24 mm)
Accuracy	0.5%	0.5%	0.5%
Bidirectional	Optional	Optional	Optional

	HV2
Primary Input	1000V, 1200V, 1500V
Rated Output	0-5Vdc
Exterior Dimension	6.57" x 2.44" x 3.58" (167.0 x 62.0 x 91.0mm)
Accuracy	0.5%
Polarity	Terminal Connection

Energy Services



Energy Services will assist clients to design, install, commission and integrate with measurement devices to provide a simple turnkey solution with ongoing monitoring and support. The central platform that ensures continuous improvement is our AcuCloud that is a non-proprietary SAS services that continuously manages equipment, monitor performance, verifies targets and bills energy users to keep everyone accountable of there sustainable goals.

NEW SERVICE

Field Services

Metering System Design

Accuenergy works closely with clients to deliver tailored solutions for new and retrofit projects, offering needs assessments, customized system designs, and seamless integration with existing infrastructure. We offer training to help teams optimize energy use and meet project goals with accurate data collection and real-time energy management.

Installation Coordination

The Installation Coordination Service facilitates coordination among all contractors, subcontractors, and suppliers, overseeing the scheduling, logistics, and execution of installations, minimizing downtime, and ensuring that all work adheres to project timelines and specifications. We help mitigate potential issues before they arise, allowing teams to focus on achieving their project goals efficiently.



System Integration and Data Management

Accuenergy provides support for integrating third-party hydro, water, natural gas, thermal, and IoT sensors with AcuCloud, ensuring that all data is captured and accessible. We configure and optimize the integration, enabling real-time monitoring, analytics, and reporting, enhancing efficiency, streamlining data management, and gaining insights into your resource usage.

Field Commissioning and Troubleshooting

Field Commissioning and Troubleshooting service ensures optimal performance of third-party meters. Our team conducts inspections and commissioning to verify that all meters are installed correctly and operating as intended, identifying and resolving issues to minimize downtime and ensure accurate data collection.

Compliance Verification

Our Compliance Verification service focuses on the inspection and verification of multi-customer meters in alignment with Measurement Canada. We conduct evaluations, perform tests and calibrations, and provide documentation to confirm compliance with regulatory requirements, helping you maintain transparency and trust with customers while avoiding potential penalties and ensuring your operations run smoothly and efficiently.



AcuCloud



Energy Management Software

AcuCloud Software is a cloud-based energy data management platform that provides facilities professionals access to real-time and historical data from power and energy meters. Users can view, download, and share energy data as well as perform sophisticated analysis and report creation.

ACCUENERGY.COM/ACUCLOUD

Key Applications

Energy Management

AcuCloud provides real-time data collection, analytics, reporting, and measurement & verification tools, supports demand management, cost tracking, regulatory compliance, sustainability goals, and integrates with building management systems, helping organizations reduce costs and improve energy management.

Meter Management

AcuCloud manages and monitors electrical, water, natural gas, and BTU meters, offering real-time status, document storage, automated alerts, and proactive maintenance notifications. It delivers data-driven insights for optimizing resource management and reducing costs.



Performance Monitoring

AcuCloud connects, stores, analyzes, and visualizes data from smart devices and equipments. It transforms data into actionable insights with automated analytics, customizable KPIs, energy management tools, and greenhouse gas tracking, enhancing performance, reducing downtime, and achieving operational savings while promoting environmental responsibility.

Tenant Billing Management

AcuCloud simplifies the billing process by supporting individual tenant bill management, accommodating any billing structure, and automating bill generation and distribution. With robust analytics, users gain insights into payment trends and tenant behavior, enabling informed decision-making.

PRODUCT COMPATIBILITY



Convenient Alerts

- Analyzes meter data to detect peaks and anomalies.
- View time, duration, and costs of occurrences, with customizable time frames.
- Identifies issues, patterns, and correlations.

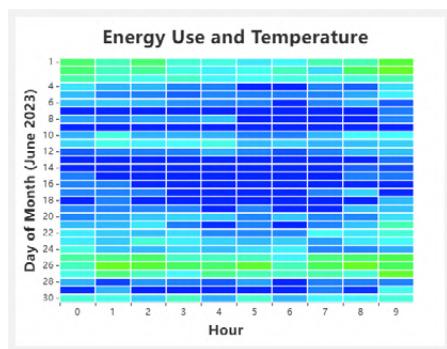

Flexible Reporting

- Enhances collaboration and decision-making.
- Customizable dashboards and automatic report generation for energy metrics.
- Downloading and emailing data for sharing.
- Pre-configured dashboards and options for tailored reports.

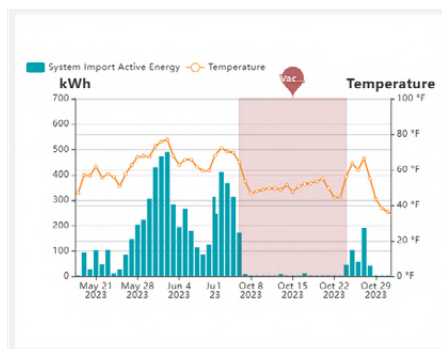

Data Storage & History

- Access to detailed energy data.
- Stores voltage, current, power, energy, power factor, demand, and pulse data.
- Records updated every 5 min.

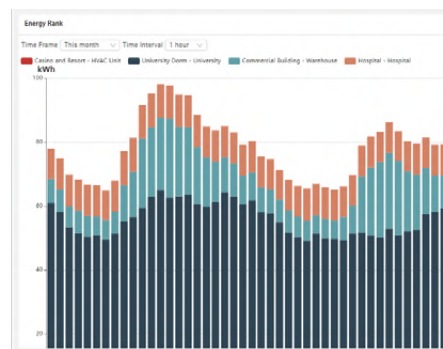

Powerful Data Analysis

- Integrates energy & performance data for analytics.
- Enhance data to actionable insights.
- Monitor energy trends, conduct detailed analyses, and manage energy projects.
- Enables informed decisions to optimize performance and reduce costs.

Data Sharing & Integration

- Forward metered data to third-party software or benchmarking frameworks.
- Supports analysis, regulatory reporting, billing, efficiency studies, and measurement & verification projects.
- Supports multiple data formats for integration.

Tariff Analytics

- Quickly assess savings when negotiating new energy contracts.
- Calculates payments based on past consumption and proposed rate.

Measurement & Verification

- Robust Measurement & Verification capabilities for assessing energy retrofits.
- Aligns with IPMVP as alternative to spreadsheets.
- Track energy conservation, calculate average consumption, and verify upgrade outcomes.
- Ensures reliable reporting and transparency.



Coming Soon

Accuenergy has been investing in the development of several new sensor series for the building automation industry. These innovations will continue to focus on our ability to provide the highest value to our customers. Please check our website in the future for product updates.

RELATIVE HUMIDITY

Relative humidity sensors with analog outputs for sensing the moisture content in a defined space (or outdoors) to maximize human comfort and energy usage of a system.

- **Relative Humidity Sensor (Room, Duct, and Outside Air)**

TEMPERATURE

Temperature sensors with analog and resistive outputs for common building automation and HVAC/R applications.

- **Averaging Sensor**
- **Duct Sensor**
- **Immersion Sensor**
- **Outside Air Sensor**
- **Probe Sensor**
- **Room/Space Sensor**

PRESSURE

Pressure sensors monitoring building static/differential pressure, proof of flow, and filter status.

- **Duct Differential Pressure Sensor**
- **Panel Differential Pressure Sensor**

CURRENT

Current sensor and switches for load trending, equipment status, and predictive maintenance.

- **Current Switch (Fixed)**
- **Current Switch (Adjustable)**
- **Current Switch (Adjustable for ECM)**
- **Current Sensor (Analog)**

GAS/IAQ

Carbon dioxide sensors to maintain fresh air for schools, office buildings, auditoriums, theaters and to provide feedback for demand control ventilation systems.

- **Carbon Dioxide Sensor**

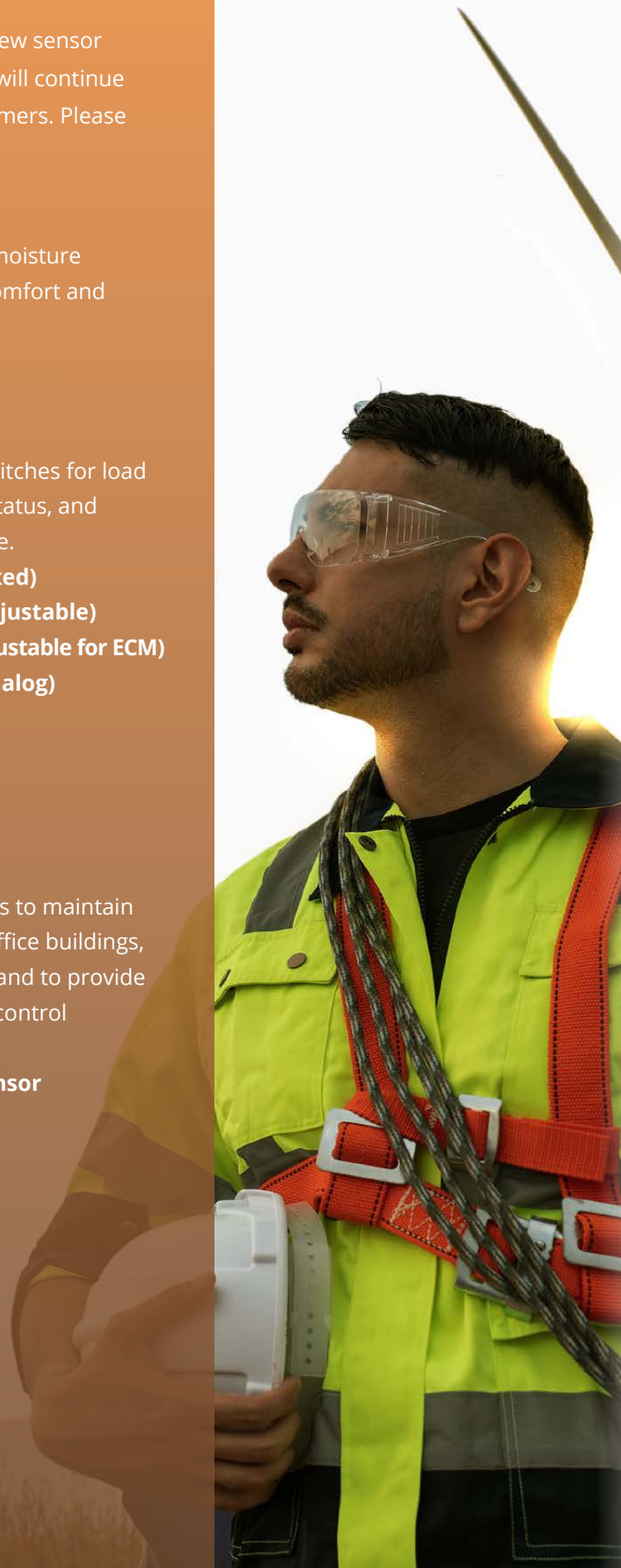

NEED HELP?

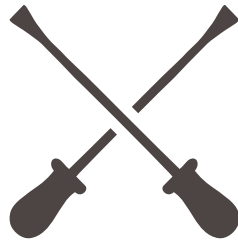

CONTACT US FOR

ENGINEERING

SALES & TECHNICAL SUPPORT



ISO 9001, 14001
& 45001 Certified



ACCUENERGY (CANADA) INC.

440 Comstock Road,
Toronto, ON M1L 2H6, Canada

TF: 1-877-721-8908

INT: +1-416-497-4100

FAX: +1-416-497-4130

E: marketing@accuenergy.com

ACCUENERGY SOUTH AFRICA (PTY) LTD.

Castle Walk Corporate Park, Block B, Cnr.

Nossob & Swakop Street, Erasmuskloof,
Pretoria, 0181, South Africa

TF: +27 (0) 87 802 6136

**ACCUENERGY PACIFIC AUTOMATION
COMPANY LTD.**

400 Continental Blvd., Suite 600
El Segundo, CA 90245, USA

TF: 1-877-721-8908

All specifications are subject to change without notice.

ACCUEENERGY
MAKE ENERGY USAGE SMARTER

www.accuenergy.com