



AcuRev 2100 Series Multi-Circuit Submeter User Manual



ACCUEVERGY

Copyright © 2024 Version: 1.1.4

This manual may not be altered or reproduced in whole or in part by any means without the expressed written consent of Accuenergy.



The information contained in this document is believed to be accurate at the time of publication, however, Accuenergy assumes no responsibility for any errors which may appear here and reserves the right to make changes without notice. Please ask the local representative for latest product specifications before ordering.

Please read this manual carefully before installation, operation and maintenance of the AcuRev 2100 Series Power Meter. The following symbols in this manual are used to provide warning of danger or risk during the installation and operation of the meters.



Electric Shock Symbol: Carries information about procedures which must be followed to reduce the risk of electric shock and danger to personal health.



Safety Alert Symbol: Carries information about circumstances which if not considered may result in injury or death.

Prior to maintenance and repair, the equipment must be de-energized and grounded. All maintenance work must be performed by qualified, competent accredited professionals who have received formal training and have experience with high voltage and current devices. Accuenergy shall not be responsible or liable for any damages or injuries caused by improper meter installation and/or operation.

Table of Contents

Chapter 1: Introduction	4
1.1 Meter Overview.....	5
1.2 Areas of Application	5
1.3 AcuRev 2100 Series Features	6
Chapter 2: Installation.....	10
2.1 Appearance and Dimensions.....	12
2.2 Installation Methods	13
2.3 Wiring	14
2.3.1 Terminals.....	14
2.3.2 Wiring Methods	16
2.3.3 Communication Port.....	22
Chapter 3: Appearance and Dimensions	24
3.1 Display Panels and Keys	25
3.2 Energy Display and Operation	27
3.3 Demand Display and Operation.....	30
3.4 IO Display and Operations	33
3.5 Real-Time Display and Key Operation.....	35
3.6 Shortcut Code	38
3.7 Basic Settings and Key Operation.....	57
3.8 Network Settings	59
3.9 Device Information and Key Operation	60
Chapter 4: Functions & Software	61
4.1 Introduction to Acuvue Software	61
4.1.1 Connecting the AcuRev 2100 to Acuvue.....	62
4.2 General Settings.....	65
4.2.1 CT ratio and Channel Mapping	69
4.3 Real Time Metering	70
4.4 Demand	71
4.5 Energy	72
4.5.1 Time of Use (TOU).....	73

Table of Contents

4.6 IO Functions	79
4.6.1 Digital Input	80
4.6.2 Relay Output.....	82
4.6.3 Digital Output.....	84
4.7 Alarm.....	86
4.8 System Event Log.....	88
4.9 Data Log.....	89
4.9.1 Reading the Data Log.....	91
4.10 Seal Button (B1) Function	93
4.10.1 How to use the Seal Button (B1).....	95
4.11 Device Information.....	95
Chapter 5: Communication	97
5.1 MODBUS Protocol Introduction.....	98
5.1.1 Transmission Mode.....	98
5.1.2 Protocol.....	98
5.1.3 CRC Check.....	100
5.2 Modbus Communication Format	101
5.2.1 Read Relay Output status (Function Code 01)	101
5.2.2 Read the status of DI (Function Code 02)	102
5.2.3 Read Data (Function Code 03).....	103
5.2.4 Control Relay Output.....	104
5.2.5 Preset/Reset Multi-Register	105
5.3 AcuRev 2100 Application Details and Parameter Address Table.....	106
5.3.1 Type of Data	106
5.3.2 Correspondence Between Communication Value and Actual Value	106
5.3.3 Address Table.....	107

AcuRev 2100 Series Power Meter

Chapter 1: Introduction

1.1 Meter Overview

1.2 Areas of Application

1.3 AcuRev 2100 Series Features



Chapter 1: Introduction

1.1 Meter Overview

The AcuRev 2100 series meter performs real-time metering, measures energy consumption and monitors power quality for up to 18 single phase circuits (or 6 three phase circuits) in one unit. It is an advanced intelligent power meter that Accuenergy developed and manufactured for the next generation smart power distribution networks. The main features include multi-tenant sub metering, cyclic display, and tamper proof, which make it highly suitable for large commercial facilities, residential apartments and industrial environments. The AcuRev 2100 series has RS485, Ethernet and wireless (WIFI) communication options as well which can be easily be connected to intelligent power distribution monitoring systems. The AcuRev 2100 also supports several I/O options (e.g. Pulse Counting from water or gas meters), making it useful in energy management systems. Due to its communication capability, ease of installation and use, this product can be easily integrated into new and existing energy management systems.

1.2 Areas of Application

- Multi-tenant sub metering/billing
 - Commercial Complex/Mall
 - Apartment/Condominiums
 - Hospitals/Public Services
 - Hotels/Office Buildings
 - Data Centers
 - LEED Projects
- Branch circuit monitoring
- Railway and Subway Systems
- Energy Management Systems
- Industrial & Utilities Applications

WARNING: *This product shall be installed in an full enclosed industrial cabinet, the access to which is strictly limited to professional personnel.*

1.3 AcuRev 2100 Series Features

Multi-function Multi-Tenants

AcuRev 2100 multi-function intelligent power meter utilizes powerful data acquisition and processing functions, which implements real-time metering and monitoring for up to 18 single phase circuits (or 6 three phase circuits) in one unit. It will also record system events, over/under limit alarming and data logging functions.

Innovative Display and Installation

Multi-tenant energy information is cycled through on the high-resolution display. Current transformer installation is made simple with plug in connector to meter.

Flexible Wiring

Users can choose measuring circuits and wiring methods. Measuring circuit can be selected as 18 single phases, or 6 three phase or 6 single phase three wire.

Features

AcuRev 2100 features and functionality are listed in the table below.

Function	Parameters Supported	Details	Accuracy
Energy	Real Energy	<ul style="list-style-type: none"> Combined energy total for all circuits Real, reactive, and apparent energy for each circuit 	Class 0.5 S
	Reactive Energy		
	Apparent Energy		
Time of Use (TOU)	4 Tariffs, 14 Schedules	<ul style="list-style-type: none"> Supports 14 Seasons, 14 Schedules, 4 Tariffs, supporting weekend and holiday settings. Supports daylight saving time and 10-year holidays with automatic switching. 	
	Daylight Savings Time		
	Holidays		

Function	Parameters Supported	Details	Accuracy	
Demand	Active Power Demand	<ul style="list-style-type: none"> Combined demand total for all circuits Active power demand, reactive power demand, apparent power demand and current demand for each circuit. 	0.5%	
	Active Power Demand Max			
	Reactive Power Demand			
	Reactive Power Demand Max			
	Apparent Power Demand			
	Apparent Power Demand Max			
	Current Demand			
	Current Demand Max			
Real Time	Voltage	<ul style="list-style-type: none"> System Line Voltage System Phase Voltage 	0.5%	
	Current			<ul style="list-style-type: none"> Combined average current for circuits being monitored Current readings for each circuit being monitored
	Active Power	<ul style="list-style-type: none"> Combined power for all circuits Active Power, Reactive Power, Apparent Power, Power Factor and Load Characteristic for each circuit being monitored 		
	Reactive Power			
	Apparent Power			
	Power Factor			
	Load Characteristic	<ul style="list-style-type: none"> System Frequency 		
Frequency				

Function	Parameters Supported	Details	Accuracy
Power Quality	THD	<ul style="list-style-type: none"> Voltage and current THD, odd THD, even THD Individual Harmonics (2~31), Current K-factor (KF), crest factor (CF), telephone interference factor (THFF), Voltage and current unbalance 	1%
	Individual Harmonics (2~31)		
	Current K Factor		
	Crest Factor		
	Voltage Unbalance		
	Current Unbalance		
	Voltage Telephone Interference Factor (THFF)		
Clock	Year/Month/Day/ Hour/Minute/Second	<ul style="list-style-type: none"> Real time configurable clock, Supports NTP via WEB2 communications module 	
Alarming	Over/Under Limit Alarming	<ul style="list-style-type: none"> Users can select parameters and configure the set point threshold over/under. The time and reason of an alarm event will be recorded. 	
Data Logging	<p>Up to 8MB via meters onboard</p> <p>Up to 8GB via WEB2 communications module</p>	<ul style="list-style-type: none"> Log real-time metering parameters, I/O status, and energy measurement. Built in WEB2 communications module provides an additional 8GB of memory that can be used for logging locally on the communication module. 	

Function	Parameters Supported	Details	Accuracy
Communication	RS485	<ul style="list-style-type: none"> Modbus RTU, BACnet MS/TP, Modbus TCP, WiFi WPA, WPA2 Enterprise security protocol, HTTP/HTTPS, FTP, SMTP, NTP, SNMP, BACnet IP, MQTT 	
	Ethernet/WIFI		
I/O	18 Digital Inputs	<ul style="list-style-type: none"> Monitors Digital Status (ON/OFF) Digital Counter 	
	6 Digital Outputs	<ul style="list-style-type: none"> Energy Pulse Output Alarm Pulse Output 	
	2 Relay Outputs	<ul style="list-style-type: none"> Latch control relay Alarm controlled relay 	

Chapter 2: Installation

2.1 Appearance and Dimensions

2.2 Installation Methods

2.3 Wiring

2.3.1 Terminals

2.3.2 Wiring Methods

2.3.3 Communication Port



Chapter 2: Installation

Before Installation

- The installation must be performed by qualified, competent, accredited professionals who have received formal training and have experience with high voltage and current devices. Appropriate safety wear (gloves, glasses, arc flash suit, etc.) is mandatory to ensure safe installation.
- During normal meter operation, caution should be used when handling the following as high voltage may be present: Terminal Blocks, Current Transformer connection nodes, Potential Transformer connection nodes and the related circuits. All primary and secondary circuits may contain lethal current and voltage. Contact with current channels must be avoided.
- The power meter and I/O modules cannot be installed on the primary side of transformers or where VA has limitations. The power meter can be only installed on the secondary side. Avoid contact with meter terminals after the completion of installation.
- Do not input voltage above the rated maximum limit of the power meter and devices connected to it. Before energizing the meter, please refer to the meter's label and specifications.
- Do not perform high voltage test / insulation experiment to output, input, or communication terminals.
- The use of shorting blocks and fuses are recommended.
- Use dry cloth to wipe the meter.
- The installation method is introduced in the chapter. Please read this chapter carefully before beginning installation.

Note: *Failure to follow manufacturer guidelines for installation and use may compromise the safety of the meter and the user.*

Note: *Any repair should only be performed by the manufacturer. A switch or circuit breaker should be utilized in the equipment. The switch should be placed close to the equipment and easy to reach. The switch is regarded as part of the breaking device.*

2.1 Appearance and Dimensions



Fig. 2-1 AcuRev 2100 Appearance

Dimensions

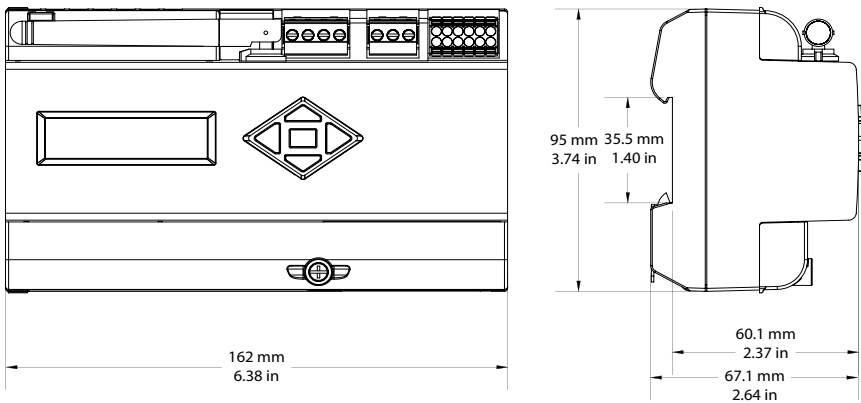

Fig. 2-2 Meter Dimensions (Meter Base, Display, External CTs)

2.2 Installation Methods

Environmental

Before installation, please check the environment, temperature, and humidity to ensure the AcuRev 2100 series meter is being placed where it will not be damaged.

1. Temperature

AcuRev 2100 operating temperature is $-25\sim 70^{\circ}\text{C}$. Exceeding this temperature range will cause damage to the meter. Please note it can influence the meters life negatively if the meter operates in extremely high or extremely low temperatures. AcuRev 2100 storage temperature range is $-40\sim 85^{\circ}\text{C}$.

2. Humidity

5% to 95% non-condensing.

3. Location

AcuRev 2100 series meter should be installed in a dry and dust free environment. Avoid exposing meter to excessive heat, radiation, and high electrical noise sources.

Installation Steps

This meter is DIN rail mounted, which fits 35 mm standard rails.

1. Insert the meter groove all the way into the rail, and flip the meter case as the Figure below shows, making the meter mounted onto the rail.

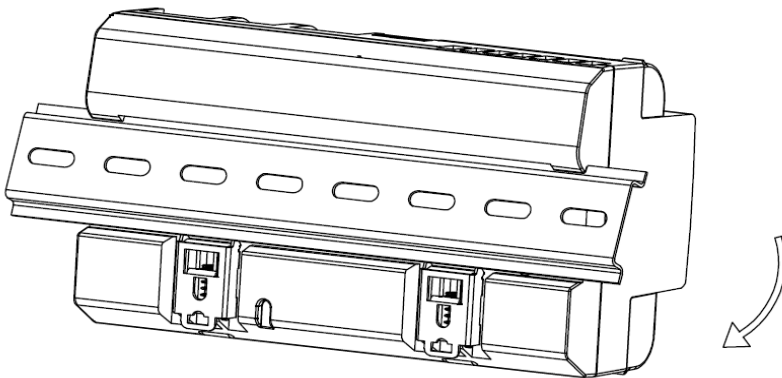
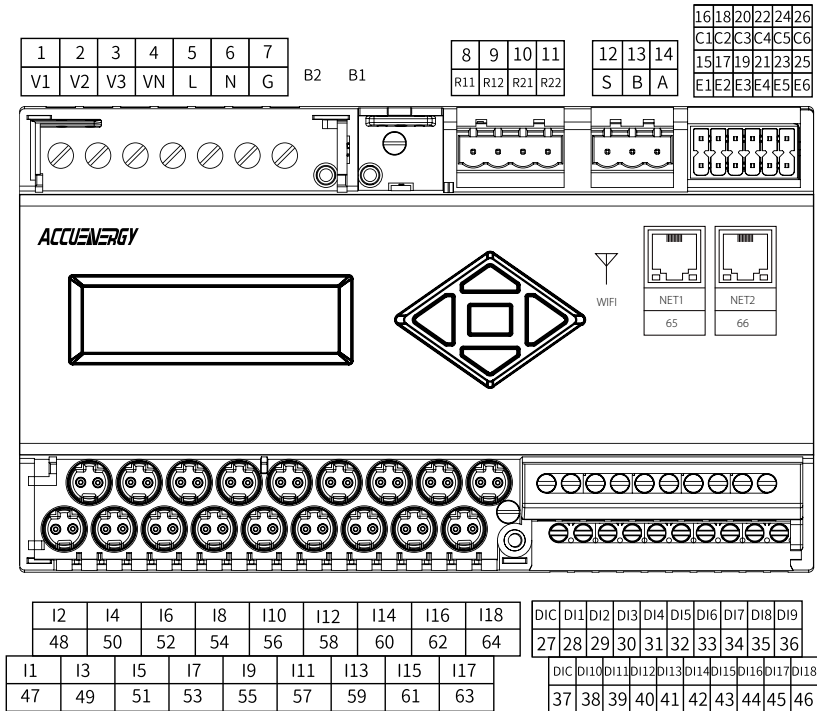

Fig. 2-3 AcuRev 2100

2.3 Wiring

2.3.1 Meter Terminals

Upper row: Voltage Input, Power Supply, Seal Button (B1), Relay Output, RS485, Digital Output, Ethernet Ports (via WEB2 module)



Lower row: Current Input, Digital Input

Fig. 2-4 AcuRev 2100 Terminals

Power Supply

AcuRev 2100 power supply is 100-415Vac, 50/60Hz or 100-300Vdc, which are universally supported. If any other power supply is required, please contact the manufacturer. The power consumption of the power meter is low during normal operation; therefore, the power supply can be either via a standalone power supply or via the measured circuit. A regulator is recommended where the voltage is not stabilized. The power supply terminal number is L/N/G.

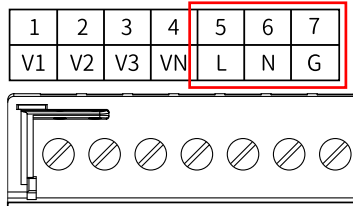

Fig. 2-5 Power Supply Wiring

Power Supply wiring is AWG22~16 or 0.6~1.5mm².

A fuse or small-sized circuit breaker is mandatory for the AcuRev 2100 Power Supply. The fuse recommendation is 1A/250Vac, time delay. If a circuit breaker is utilized, it must be CE certified and comply with IEC 947 standard.

An isolated transformer or EMC filter should be used in the auxiliary power supply loop if there is a power quality issue in the power supply.

Voltage Input Signal

400Vac L-N, 690Vac L-L. A fuse (typical 1A/250Vac) or air circuit breaker must be used in the voltage input loop.

Current Input Connection

For CT Connection, the CTs are terminated and plugged directly into the meter using connectors on the CT. If the CT does not have this connector an adapter can be used to connect the CT successfully to the meter.

SnapOn Connector Polarity	
North America	White lead is positive. Black lead is negative.
International	Red lead is positive. White lead is negative.

Vn Connection

Vn is the voltage reference point of AcuRev 2100, a low resistance to Vn connection contributes to a better measurement accuracy. Vn connection is related to the system wiring. Please refer to "Wiring Methods" for details.

2.3.2 Wiring Methods

AcuRev 2100 wiring methods can be selected in system parameter settings. Inline defaults to 3-phase 4-line(3LN), load wiring can be set to single-phase (1LN), three phase four-wire (3LN), single-phase three-wire (2LN), three phase 3 wire (2LL), and network wiring (special case of 3LN).

1. Single Phase (1LN) Option 1

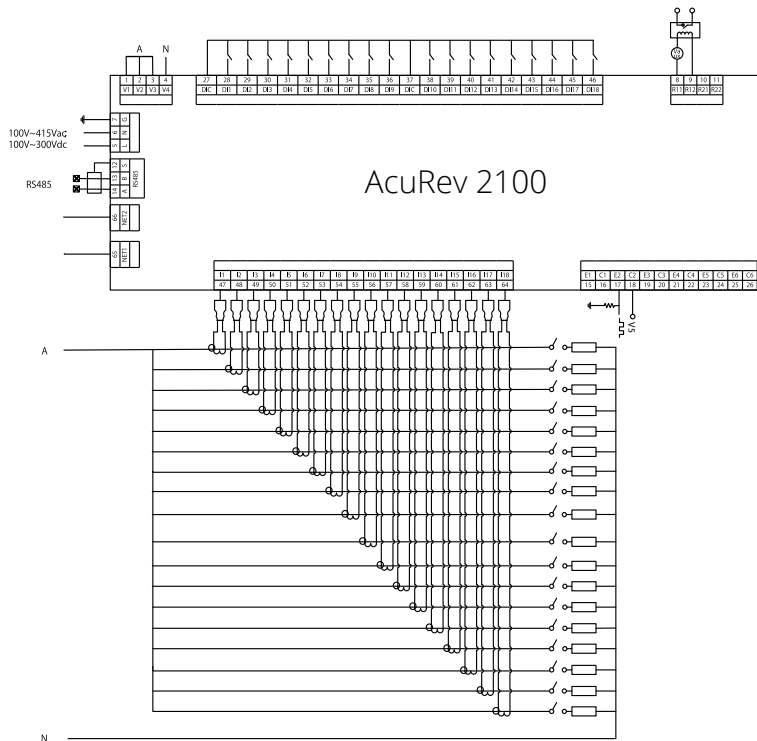

Fig. 2-6a Single Phase Option 1

Table 2-1 Single Phase (1LN) Option 1

User Channel	Phase A
Channel 1	11
Channel 2	12
Channel 3	13
Channel 4	14
Channel 5	15
Channel 6	16

Channel 7	I7
Channel 8	I8
Channel 9	I9
Channel 10	I10
Channel 11	I11
Channel 12	I12
Channel 13	I13
Channel 14	I14
Channel 15	I15
Channel 16	I16
Channel 17	I17
Channel 18	I18

2. Single Phase (1LN) Option 2

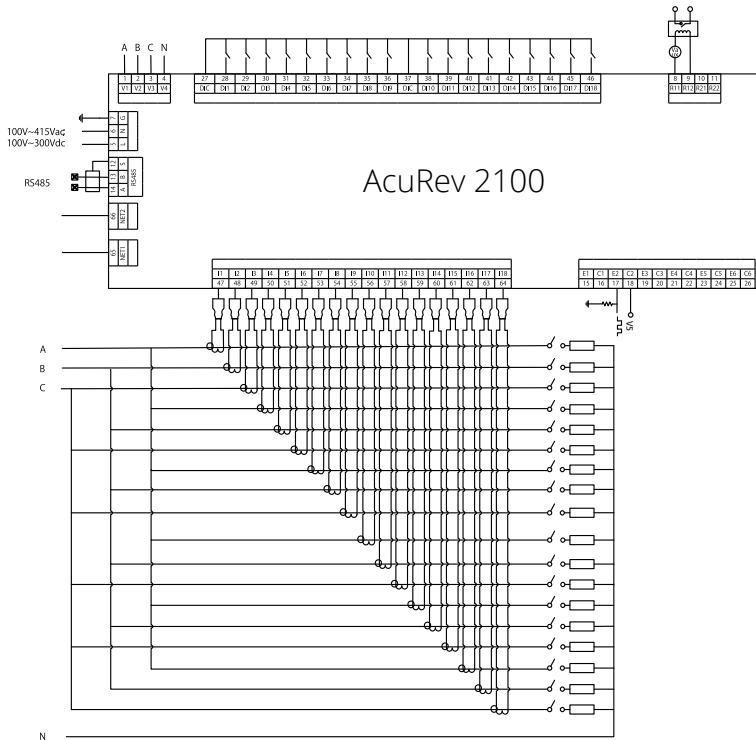

Fig. 2-6b Single Phase Option 2

Table 2-2 Single Phase (1LN) Option 2

User Channel	Phase A	Phase B	Phase C
Channel 1	I1		
Channel 2		I2	
Channel 3			I3
Channel 4	I4		
Channel 5		I5	
Channel 6			I6

Channel 7	I7		
Channel 8		I8	
Channel 9			I9
Channel 10	I10		
Channel 11		I11	
Channel 12			I12
Channel 13	I13		
Channel 14		I14	
Channel 15			I15
Channel 16	I16		
Channel 17		I17	
Channel 18			I18

3. Three Phase 4 Wire (3LN)

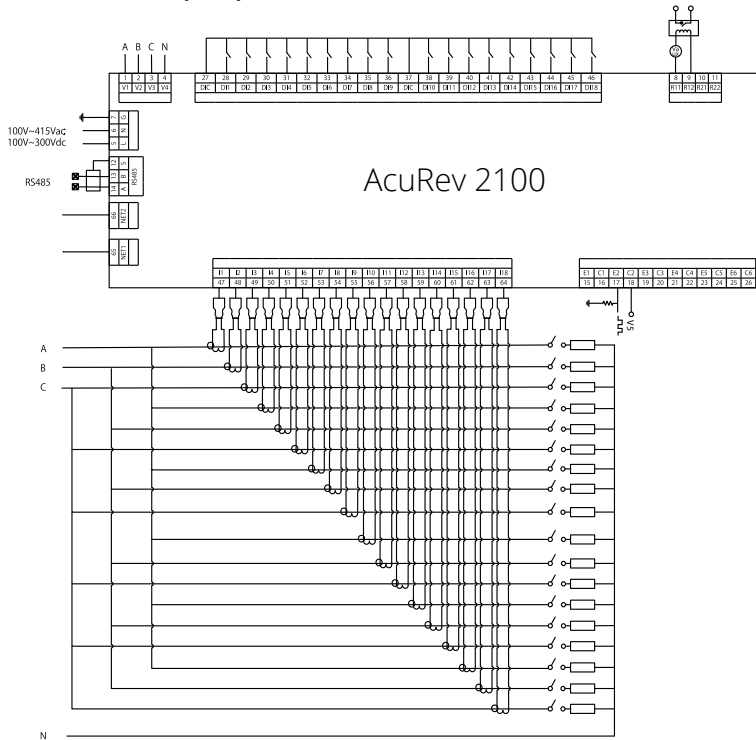

Fig. 2-7 Three-Phase Four-Wire

Table 2-3 Three-Phase Four-Wire (3LN)

User Channel	Phase A	Phase B	Phase C
Channel 1	I1	I2	I3
Channel 2	I4	I5	I6
Channel 3	I7	I8	I9
Channel 4	I10	I11	I12
Channel 5	I13	I14	I15
Channel 6	I16	I17	I18

4. Two Phase 3 Wire (2LN)

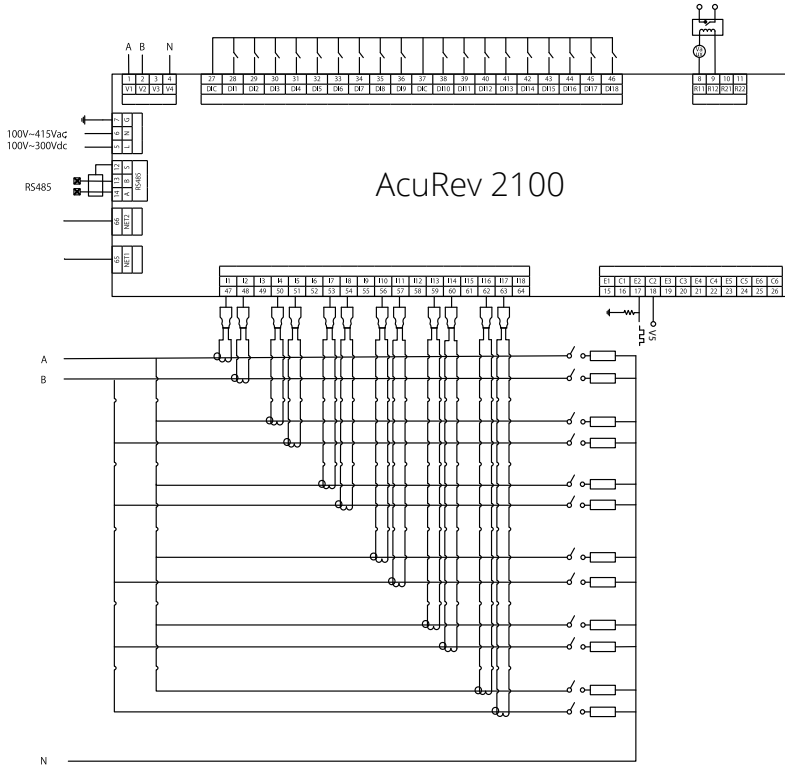

Fig. 2-8 Single Phase 3-Wire (2LN)

Table 2-4 Two Phase Three Wire (2 Hot Phases - 1 Neutral)

User Channel	Phase A	Phase B
Channel 1	I1	I2
Channel 2	I4	I5
Channel 3	I7	I8
Channel 4	I10	I11
Channel 5	I13	I14
Channel 6	I16	I17

5. Three Phase 3 Wire (2LL)

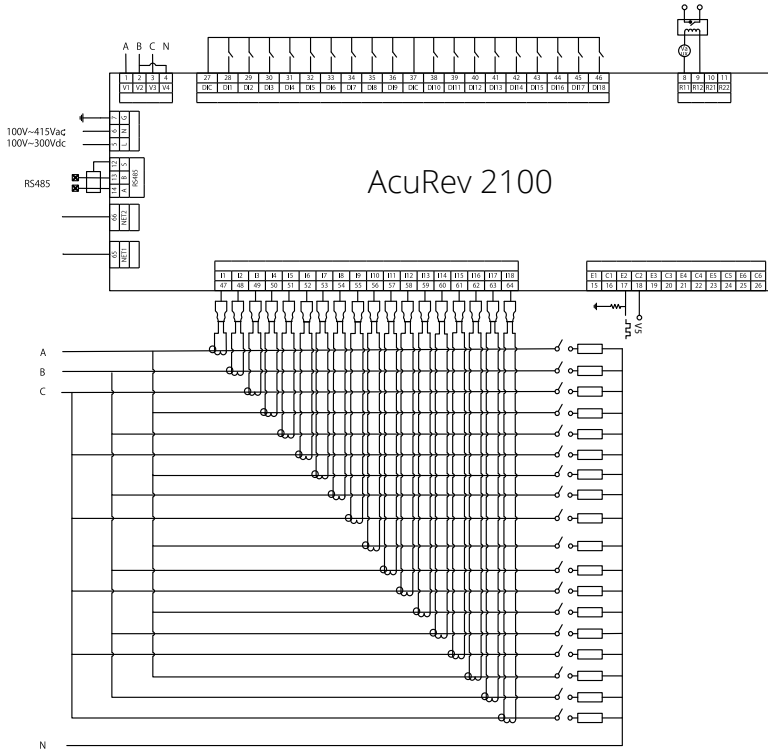

Fig. 2-9 Three-Phase Three-Wire (2LL)

Table 2-5 Three Phase 3 Wire (2LL)

User Channel	Phase A	Phase B	Phase C
Channel 1	I1	I2	I3
Channel 2	I4	I5	I6
Channel 3	I7	I8	I9
Channel 4	I10	I11	I12
Channel 5	I13	I14	I15
Channel 6	I16	I17	I18

6. Network Wiring Diagram (Special Case of 3LN)

Network wiring is a special case of 3LN. Its current inputs are composed of two in each user channel.

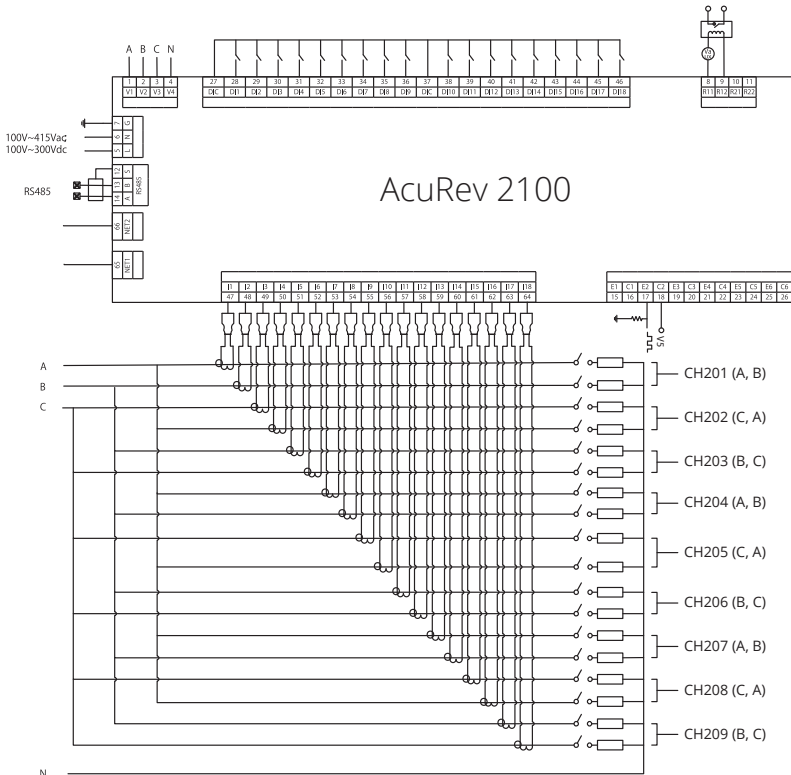

Fig. 2-10 Network Wiring

Table 2-6 Networking Wiring Diagram

User Channel	Phase A	Phase B	Phase C
CH201(A,B)	I1	I2	-
CH202(C,A)	I4	-	I3
CH203(B,C)	-	I5	I6
CH204(A,B)	I7	I8	-

CH205(C,A)	I10	-	I9
CH206(B,C)	-	I11	I12
CH207(A,B)	I13	I14	-
CH208(C,A)	I16	-	I15
CH209(B,C)	-	I17	I18

2.3.3 Communication Port

AcuRev 2100 communication utilizes RS485 port, via Modbus-RTU and BACnet MS/TP protocol. The wiring terminals are A, B, S (14, 13, 12), where **A** is positive, **B** is negative, and **S** is the shield terminal. The maximum distance of shielded twisted pair cable is 1200 m.

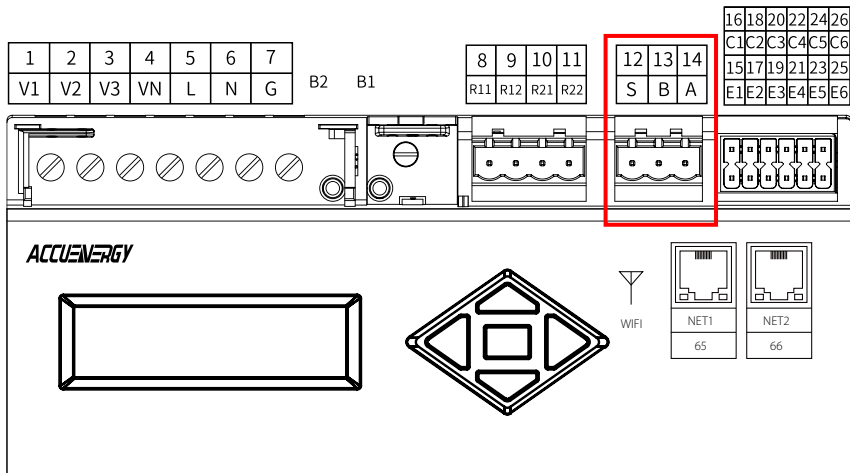

Figure 2-11 Communication Port

If the master device does not have RS485 but RS232 port, a RS232/485 converter can be utilized. Typical RS485 network topologies include line, circle and star (wye).

In order to improve communication quality, please pay attention to:

1. High-quality shielded twisted pair cable is very important, AWG22 (0.6mm²) or lower is recommended. Two cables should be different colors.

-
2. Pay attention to "single point earthing". It means there is only one point of the shielding connected to ground in a single communication link.
 3. Every A (+) should be connected to A(+), B(-) to B(-), or it will influence the network, even damage the communication interface.
 4. "T" type connection topology should be avoided. This means no new branches except from the starting point.
 5. Keep communication cables away as much as possible from sources of electrical noise. When several devices are connected (daisy chain) to the same long communication line, an anti-signal reflecting resistor (typical value 1200-3000 Ω , 0.25W) is often used at the end of the circuit (the last meter of the chain) if the communication quality is distorted.
 6. Use RS232/RS485 or USB/RS485 converter with optical isolated output and surge protection.

Chapter 3: Appearance & Dimensions

3.1 Display Panels and Keys

3.2 Energy Display and Operation

3.3 Demand Display and Operation

3.4 IO Display and Operations

3.5 Real-Time Display and Key Operation

3.6 Power Quality Display and Key Operation

3.7 Shortcut Code

3.8 Basic Settings and Key Operation

3.9 Network Settings

3.10 Device Information and Key Operation

Chapter 3: Appearance & Dimensions

3.1 Display Panels and Keys

The AcuRev 2100 meter consists of one LCD screen and five keys. Refer to chapter 2 section 2.1 for more details regarding the dimensions of the LCD display.

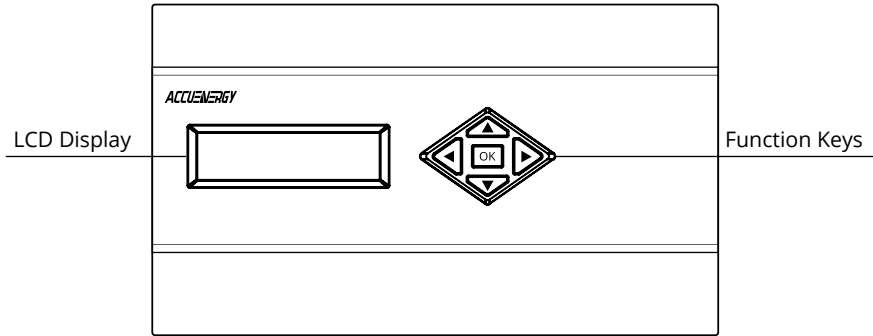

Fig. 3-1 AcuRev 2100 and LED Indicator

Table 3-1 Function Keys Illustration

Key	Function
▲	Up Scroll up or increase value (Editing mode)
▼	Down Scroll down or decrease value (Editing mode)
◀	Left Move cursor to the left
▶	Right Move cursor to the right
OK	OK Confirm setting/value

Key Combination

Pressing the **Left** and **Right** buttons at the same time for a second is the quick exit function. In any screen, pressing this key combination can return to the main menu screen. The basic settings and network setting screens are only available with this key combination to return back to the main menu screen.

Display

When first powered on the **ACCUENERGY** will be displayed on the LCD screen, after 2 seconds the main menu screen will appear.

Settings Mode

In the main menu screen, users can use the arrow keys to navigate to different options and use the **OK** button to enter any of the menu options. When entering either the **Settings** or **Network Settings** options users will be prompted with a password screen. The default password is **0000**, if password has been changed users can use the arrow keys to enter in the required password. Table 3-2 below shows the main menu options for the AcuRev 2100 meter.

Table 3-2 AcuRev 2100 Main Menu

Menu Display	Function
D (Demand)	Demand Readings
INFO	Device Information
IO	Digital Input/Output Readings
E (Energy)	Energy Readings
SET	Meter Settings
NET	Network Settings
MUL (Real-Time)	Real-Time Readings
M	Shortcut Code

By default only the E, D, IO, MUL, and M options are displayed on main menu screen. To view the SET, NET, and INFO options press either the Right or Left arrow keys to scroll to these options.

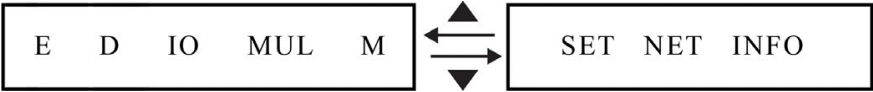

Fig. 3-2 Main menu screen sequence

3.2 Energy Display and Operation

On the main menu screen move the cursor over to **E** and press **OK** to enter to view the energy readings for the meter. Use the **Left** or **Right** buttons to move between the different channels (1-18) as well as the in-line (meter total) energy. Press the **Up** and **Down** buttons to select the different energy readings for each channel/tenant. Users can press **OK** to return to the main menu screen.

If TOU energy is not used, the meter will only display real-time energy readings.

Table 3-3 Energy Display

Parameter	Screen
Apparent Energy	ES
Current Month Total Energy	MTnS
Current Month Tariff 1 Energy	MT1S
Current Month Tariff 2 Energy	MT2S
Current Month Tariff 3 Energy	MT3S
Current Month Tariff 4 Energy	MT4S
Prior Month Tariff 1 Energy	UT1S
Prior Month Tariff 2 Energy	UT2S
Prior Month Tariff 3 Energy	UT3S
Prior Month Tariff 4 Energy	UT4S
Reactive Energy	EQ
Real-Time Energy	EP

1. Single Phase 1 Wire (1LN)

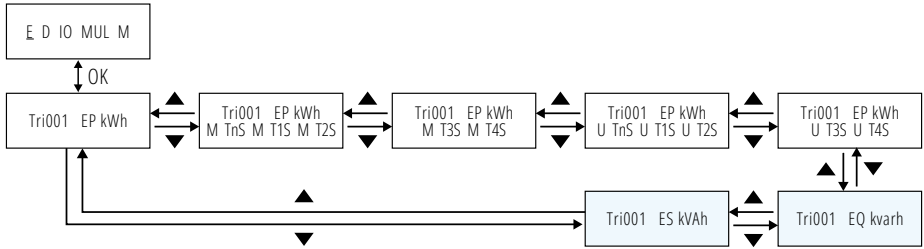

Fig. 3-3 Single Phase 1 Wire Energy Display

2. Three Phase 4 Wire (3LN)

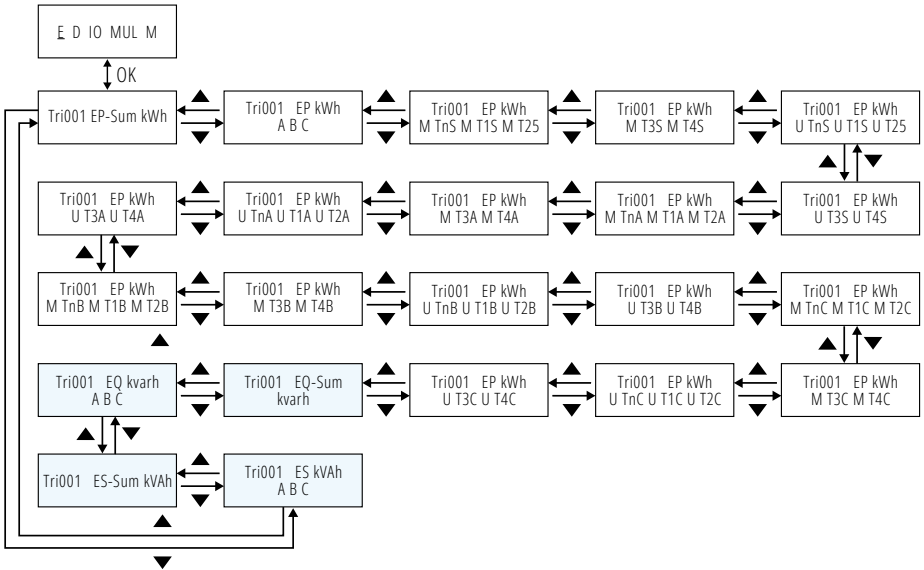

Fig. 3-4 Three Phase 4 Wire Energy Display

3. Single Phase 3 Wire (2LN)

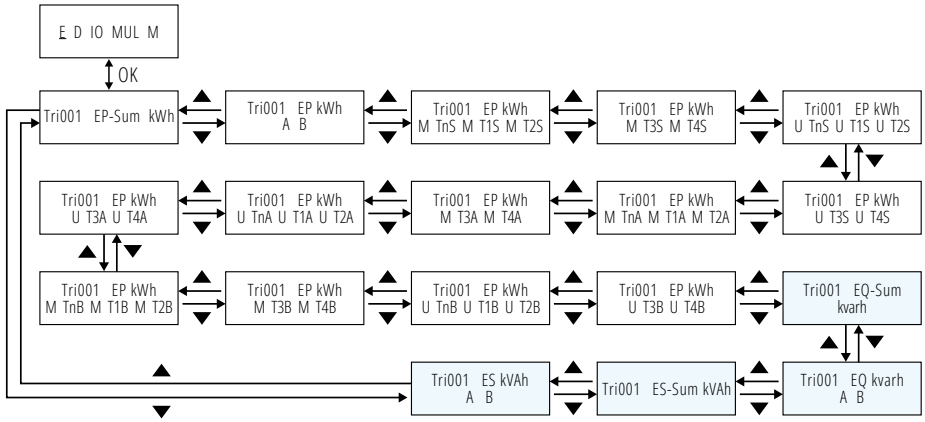

Fig. 3-5 Single Phase 3 Wire Energy Display

4. 2LL Energy Display

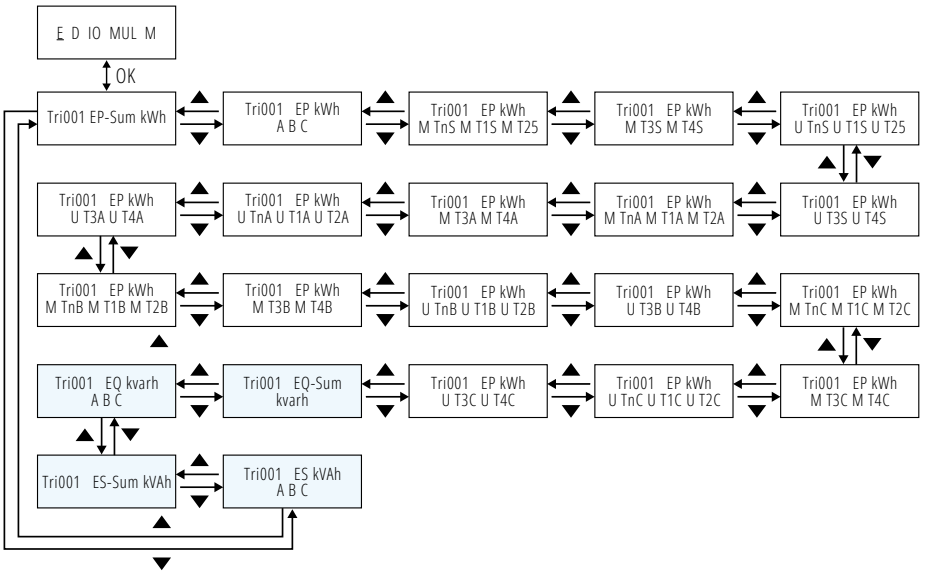

Fig. 3-6 Three Phase 3 Wire Energy Display

5. Network Energy Display

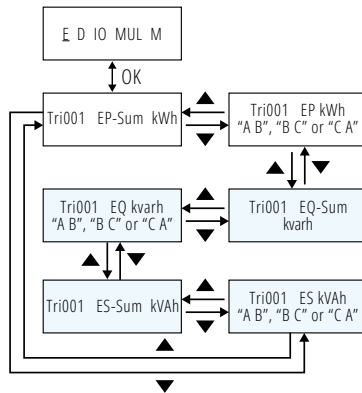

Fig. 3-7 Two Phase 4 Wire Energy Display

3.3 Demand Display and Operation

On the main menu use the arrow keys to navigate to **D**, then press **OK** to view the meters demand readings. Using the **Left** and **Right** buttons to move between the different channels (1-18) as well as the in-line (meter total) demand. Use the **Up** and **Down** keys to view the different demand readings for each channel. Users can press the **OK** button to return to the main menu.

Table 3-4 Demand Display

Parameter	Display
Demand	DMD
Active Demand	DMD-P
Reactive Demand	DMD-Q
Apparent Demand	DMD-S
Current Demand	DMD-I
Predicted Demand	Pre
Maximum Demand	Max

For different wiring configurations, the demand data display will be different:

1. Single Phase 1 Wire (1LN)

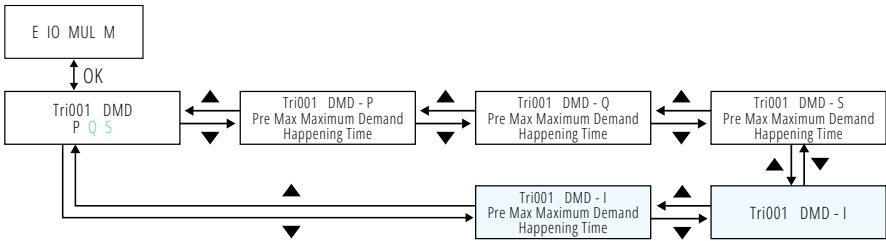

Fig. 3-8 Single Phase 1 Wire Demand Display

2. Three Phase 4 Wire (3LN)

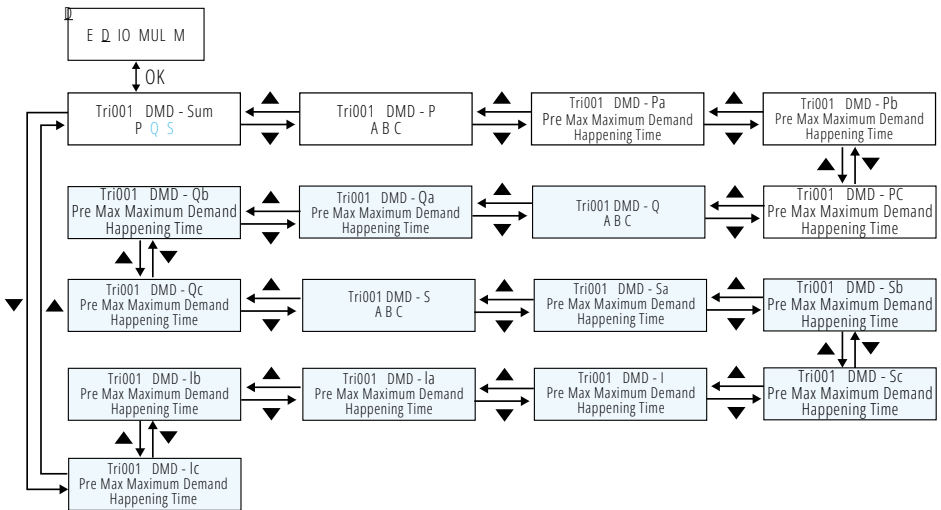

Fig. 3-9 Three Phase 4 Wire Demand Display

3. Single Phase 3 Wire (2LN)

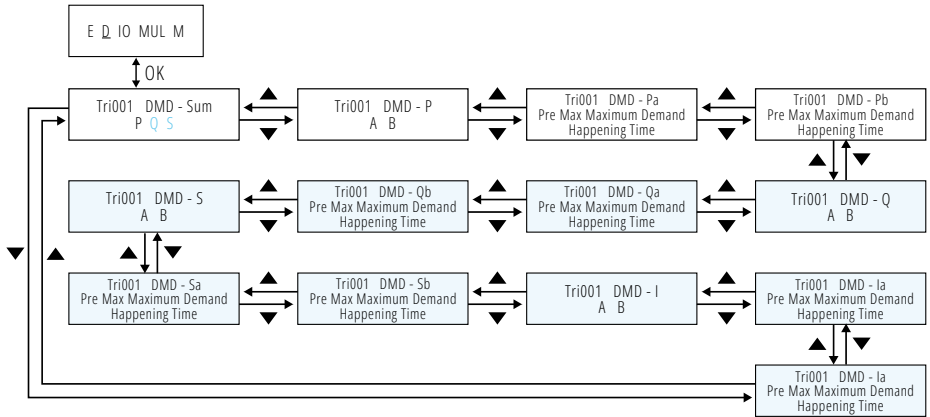

Fig. 3-10 Single Phase 3 Wire Demand Display

4. 2LL Demand Display

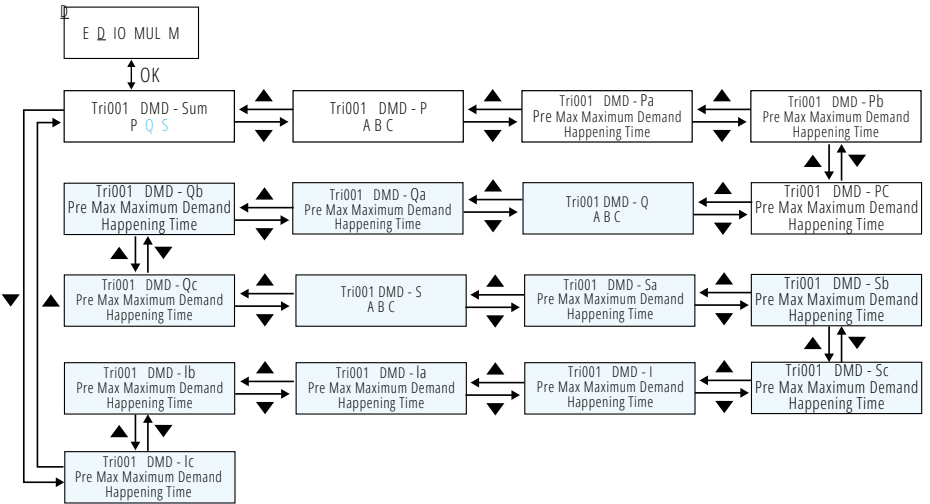

Fig. 3-11 Three Phase 3 Wire Demand Display

5. Network Demand Display

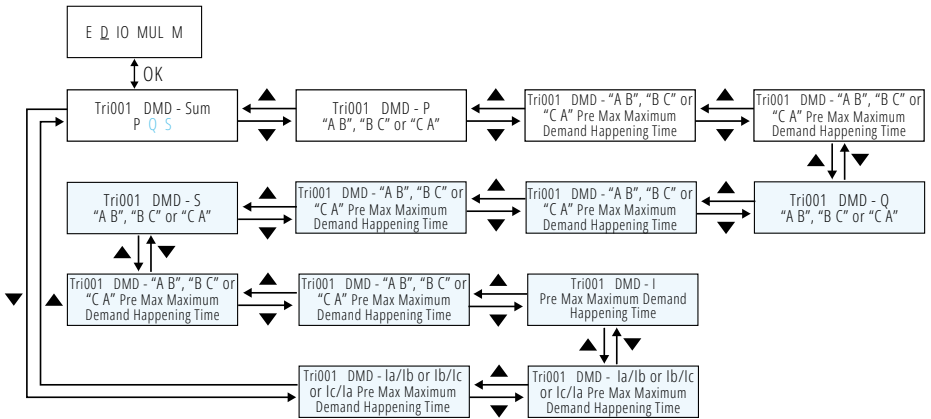

Fig. 3-12 Three Phase 3 Wire Demand Display

3.4 IO Display and Operations

On the main menu use the arrow keys to navigate to **IO** and then press the **OK** to view the IO data. Use the **Up** and **Down** buttons to view different IO readings. Users can press the **OK** button to return to the main menu.

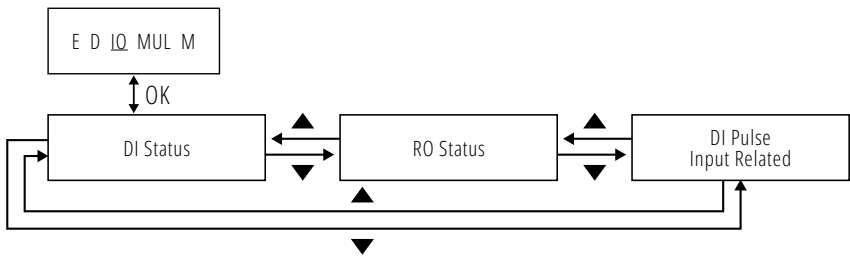

Fig. 3-13 IO Display

1st Screen includes DI Status channels 1-10, and the second screen includes channels 11-18.

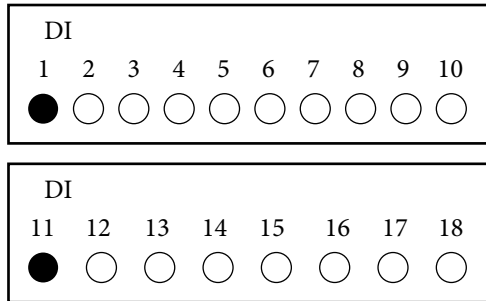

Fig. 3-14 Digital Input Status Display

- indicates this channel DI status "OFF" or Pulse Input
- indicates DI Status "ON"

3rd Screen, RO Status, 2-Channel RO.

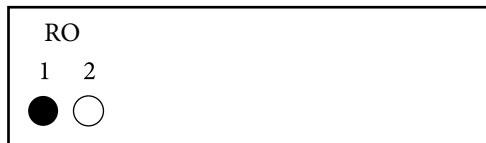

Fig. 3-15 Relay Output Display

- indicates this channel RO status "OFF"
- indicates this RO Status "ON"

4th Screen, DI pulse input number and its parameter. Pressing Left and Right to view channels 1-18.

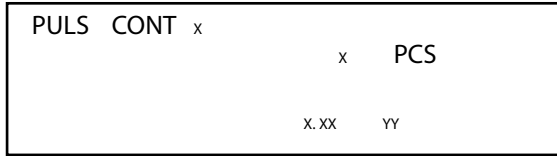

Fig. 3-16 DI Pulse Input Display

CONT X = DI Channel number

PCS = Pulse Count

yy = Scaled Value

3.5 Real-Time Display and Key Operation

On the main menu use the arrow keys to navigate to **MUL** (Real-time) and press the **OK** button to view the real time parameter readings for the meter. Use the **Left** and **Right** buttons to move between different channels (1-18) as well as the inline parameters (meter total). Use the **Up** and **Down** buttons to scroll between the different real time parameters. Users can press the **OK** button to return to the main menu.

Table 3-5 Real Time Data Display

Parameter	Display
Total Time	MUL-Sum
Active Power	MUL-P
Reactive Power	MUL-Q
Apparent Power	MUL-S
Real-Time Current Value	MUL-I
Power Factor	MUL-PF
Load Type	MUL-Load Type

Parameter	Display
Phase Voltage	MUL-Phase U
Phase Average Voltage	Uavg
Line Voltage	MUL-Line U
Line Voltage Average	Ulavg

For different wiring configurations, the real time data display will be different:

1. Single Phase 2-Wire (1LN)

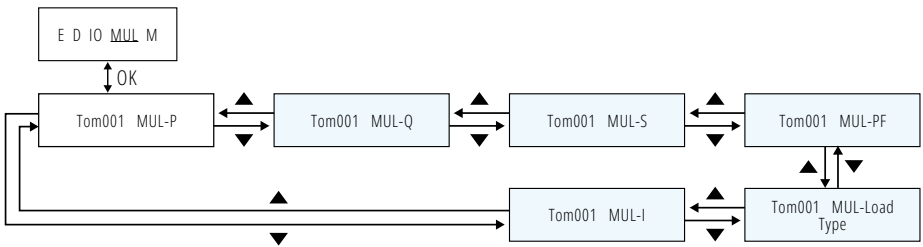

Fig. 3-17 Single Phase 1 Wire Real-Time Display

2. Three Phase 4-Wire (3LN)

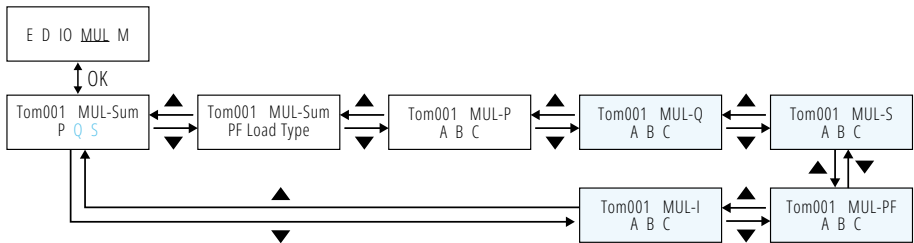

Fig. 3-18 Three Phase 4 Wire Real-Time Display

3. Single Phase 3-Wire (2LN)

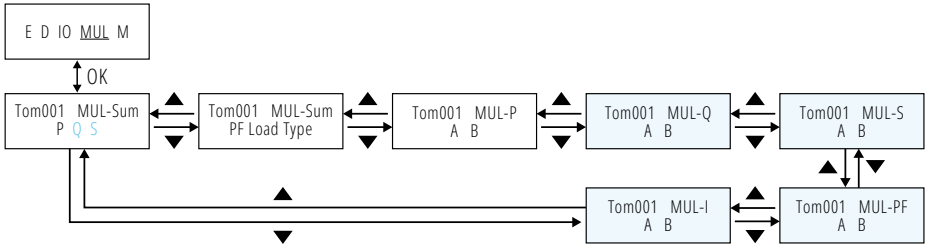

Fig. 3-19 Single Phase 3 Wire Real-Time Display

4. 4-Wire Inline

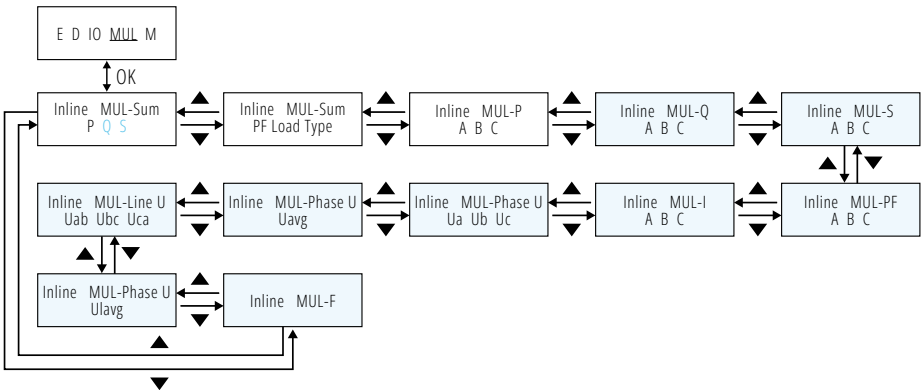

Fig. 3-20 Inline Real-Time Display

5. Two Phase 3 Wire (2LL) real-time display

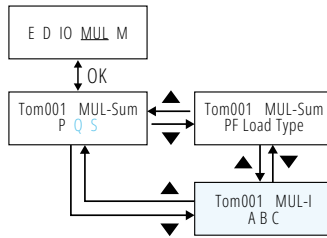

Fig. 3-21 Two Phase 3 Wire Real-Time Display

6. Network real-time display

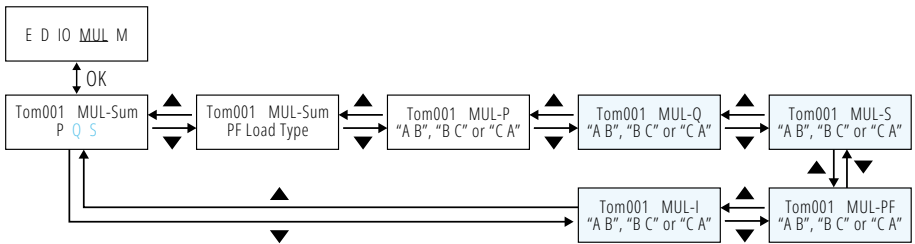

Fig. 3-22 Three Phase 4 Wire Real-Time Display

3.6 Shortcut Code

The AcuRev 2100 supports a shortcut code that allows users to enter the code for a certain parameter and this parameter will be displayed on screen. Users can use this function if looking for a particular parameter rather than scrolling through the many screens in order to find it. On the main menu page use the arrow keys to navigate to **M** and press the **OK** to enter the Shortcut Key page.

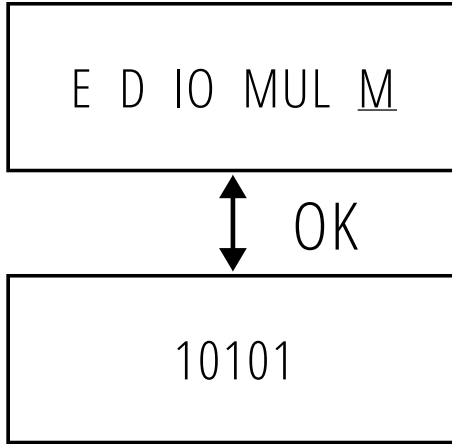

Fig. 3-23 Shortcut Code

Press the **Left** and **Right** buttons to move the cursor over to different digits. Press the **Up** and **Down** buttons to change the value of the digit. After inputting the Shortcut Code, press **OK** to enter the corresponding page.

The Shortcut Code consists of five digits. The first digit on the left is to choose functions. The following tables provide the shortcut code to all the available parameters supported on the AcuRev 2100 meter.

Table 3-7 Short Cut Code First Digit Representation

Function	Shortcut
Energy Measurement	1
Demand Measurement	2
Digital Input Digital Output	3
Real-Time Measurement	4

1. Single Phase 1-Wire (1LN):

Table 3-8 Single Phase 1-Wire Shortcut Code

Function	User	Screen Number	Code	Content
Energy (No TOU, only Real-time Energy)	1-8	1	10101-10118	Real-time energy
		2	10201-10218	This month total energy, this month tariff 1 energy, this month tariff 2 energy
		3	10301-10318	This month tariff 3 energy, this month tariff 4 energy
		4	1-18	Prior month total energy, prior month tariff 1 energy, prior month tariff 2 energy
		5	10501-10518	Prior month tariff 3 energy, prior month tariff 4 energy
		6	10601-10618	Reactive energy
		7	10701-10718	Apparent energy
Demand	1-18	1	20101-20118	Real power demand, reactive power demand, apparent power demand
		2	20201-20218	Real power demand prediction, real power demand peak and happening time
		3	20301-20318	Reactive power demand prediction, reactive power demand peak and happening time
		4	20401-20418	Apparent power demand prediction, apparent power demand peak and happening time
		5	20501-20518	Current demand

Function	User	Screen Number	Code	Content
		6	20601-20618	Current demand prediction, current demand peak and happening time
Digital Input Digital Output	DI Channel 1-8	1	30101-30108	DI status
		2	30201-30208	RO status
		3	30301-30308	DI pulse input related
Real-time	1-18	1	40101-40118	Real power
		2	40201-40218	Reactive power
		3	40301-40318	Apparent power
		4	40401-40418	Power factor
		5	40501-40518	Load type
		6	40601-40618	Current

2. Three Phase 4-Wire (3LN):

Table 3-9 Three Phase 4-Wire Shortcut Code

Function	User	Screen Number	Code	Content
Energy (No TOU, only Real- time Energy)	1-18	1	12101-12118	Total real energy
		2	12201-12218	Phase A,B,C real energy
		3	12301-12318	This month total power-sharing, this month tariff 1 energy, this month tariff 2 energy
		4	12401-12418	This month tariff 3 energy, this month tariff 4 energy
		5	12501-12518	Prior month total power sharing, prior month tariff 1 energy, prior month tariff 2 energy
		6	12601-12618	Prior month tariff 3 energy, prior month tariff 2 energy
		7	12701-12718	Phase A this month total power- sharing Phase A this month tariff 1 energy, Phase A this month tariff 2 energy
		8	12801-12818	Phase A this month tariff 3 energy, Phase A this month tariff 4 energy
		9	12901-12918	Phase A prior month total energy, Phase A prior month tariff 1 energy, Phase A prior month tariff 1 energy, Phase A prior month tariff 2 energy
		10	13001-13018	Phase A prior month tariff 3 energy, Phase A prior month tariff 4 energy

Function	User	Screen Number	Code	Content
		11	13101-13118	Phase B this month total energy, Phase B this month tariff 1 energy, Phase B this month tariff 2 energy
		12	13201-13218	Phase B this month tariff 3 energy, Phase B this month tariff 4 energy
		13	13301-13318	Phase B prior month total energy, Phase B prior month tariff 1 energy, Phase B prior month tariff 2 energy
		14	13401-13418	Phase B prior month tariff 3 energy, Phase B prior month tariff 4 energy
		15	13501-13518	Phase C this month total energy, Phase C this month tariff 1 energy, Phase C this month tariff 2 energy
		16	13601-13618	Phase C this month tariff 3 energy, Phase C this month tariff 4 energy
		17	13701-13718	Phase C prior month total energy, Phase C prior month tariff 1 energy, Phase C prior month tariff 2 energy
		18	13801-13818	Phase C prior month tariff 3 energy, Phase C prior month tariff 4 energy
		19	13901-13918	Total reactive energy
		20	14001-14018	Phase A, B, C reactive energy
		21	14101-14118	Total apparent energy
		22	14201-14218	Phase A, B, C apparent energy

Function	User	Screen Number	Code	Content
Demand	1-18	1	22101-22118	System active power demand, system reactive power demand, system apparent power demand
		2	22201-22218	Phase A, B, C active power demand
		3	22301-22318	Phase A real power demand prediction, Phase A real power demand peak and load time
		4	22401-22418	Phase B real power demand prediction, Phase B real power demand peak and load time
		5	22501-22518	Phase C real power demand prediction, Phase C real power demand peak and load time
		6	22601-22618	Phase A, B, C reactive power demand
		7	22701-22718	Phase A reactive power demand prediction, Phase A reactive power demand peak and load time
		8	22801-22818	Phase B reactive power demand prediction, Phase B reactive power demand peak and load time
		9	22901-22918	Phase C reactive power demand prediction, Phase C reactive power demand peak and load time
		10	23001-23018	Phase A, B, C apparent power demand

Function	User	Screen Number	Code	Content
		11	23101-23118	Phase A apparent power demand prediction, Phase A apparent power demand peak and load time
		12	23201-23218	Phase B apparent power demand prediction, Phase B apparent power demand peak and load time
		13	23301-23318	Phase C apparent power demand prediction, Phase C apparent power demand peak and load time
		14	23401-23418	Phase A, B, C current demand
		15	23501-23518	Phase A current demand prediction, Phase A current demand peak and load time
		16	23601-23618	Phase B current demand prediction, Phase B current demand peak and load time
		17	23701-23718	Phase C current demand prediction, Phase C current demand peak and load time
Digital Input Digital Output	DI Channel 1-8	1	30101-30108	DI status
		2	30201-30208	RO status
		3	30301-30308	DI pulse input related

Function	User	Screen Number	Code	Content
Real-time	1-18	1	42101-42118	Total active power, total reactive power, total apparent power
		2	42201-42218	Total power factor, total load type
		3	42301-42318	Phase A, B, C active power
		4	42401-42418	Phase A, B, C reactive power
		5	42501-42518	Phase A, B, C apparent power
		6	42601-42618	Phase A, B, C power factor
		7	42701-42718	Phase A, B, C current

3. Single Phase 3-Wire (2LN):

Table 3-10 Single Phase 3-Wire Shortcut Code

Function	User	Screen Number	Code	Content
Energy (No TOU, only Real-Time Energy)	1-18	1	16101-16118	Real-time energy
		2	16201-16218	Phase A, B real-time energy
		3	16301-16318	This month total power sharing, this month tariff 1 energy, this month tariff 2 energy
		4	16401-16418	This month tariff 3 energy, this month tariff 4 energy
		5	16501-16518	Prior month total power-sharing, prior month tariff 1 energy, prior month tariff 2 energy
		6	16601-16618	Prior month tariff 3 energy, prior month tariff 4 energy

Function	User	Screen Number	Code	Content
		7	16701-16718	Phase A this month total energy, Phase A this month tariff 1 energy, Phase A this month tariff 2 energy
		8	16801-16818	Phase A this month tariff 3 energy, Phase A this month tariff 4 energy
		9	16901-16918	Phase A prior month total energy, Phase A prior month tariff 1 energy, Phase A prior month tariff 2 energy
		10	17001-17018	Phase A prior month tariff 3 energy, Phase A prior month tariff 4 energy
		11	17101-17118	Phase B this month total energy, Phase B this month tariff 1 energy, Phase B this month tariff 2 energy
		12	17201-17218	Phase B this month tariff 3 energy, Phase B this month tariff 4 energy
		13	17301-17318	Phase B prior month total energy, Phase B prior month tariff 1 energy, Phase B prior month tariff 2 energy
		14	17401-17418	Phase B prior month tariff 3 energy, Phase B prior month tariff 4 energy
		15	17501-17518	Total reactive energy
		16	17601-17618	Phase A, B reactive energy
		17	17701-17718	Total apparent energy
		18	17801-17818	Phase A, B apparent energy
		Demand	1-18	1
2	26201-26218			Phase A, B active power demand

Function	User	Screen Number	Code	Content		
		3	26301-26318	Phase A real power demand prediction, Phase A real power demand peak and load time		
		4	26401-26418	Phase B real power demand prediction, Phase B real power demand peak and load time		
		5	26501-26518	Phase A, B reactive power demand		
		6	26601-26618	Phase A reactive power demand prediction, Phase A reactive power demand peak and load time		
		7	26701-26718	Phase B reactive power demand prediction, Phase B reactive power demand peak and load time		
		8	26801-26818	Phase A, B apparent power demand		
		9	26901-26918	Phase A apparent power demand prediction, Phase A apparent power demand peak and load time		
		10	27001-27018	Phase B apparent power demand prediction, Phase B apparent power demand peak and load time		
		11	27101-27118	Phase A, B current demand		
		12	27201-27218	Phase A current demand prediction, Phase A current demand peak and load time		
		13	27301-27318	Phase B current demand prediction, Phase B current demand peak and load time		
		Digital Input Digital Output	DI Channel 1-8	1	30101-30108	DI status
				2	30201-30208	RO status
3	30301-30308			DI pulse input related		

Function	User	Screen Number	Code	Content
Real-time	1-18	1	46101-46118	Total active power, total reactive power, total apparent power
		2	46201-46218	Total power factor, total load type
		3	46301-46318	Phase A, B active power
		4	46401-46418	Phase A, B reactive power
		5	46501-46518	Phase A, B apparent power
		6	46601-46618	Phase A, B power factor
		7	46701-46718	Phase A, B current

4. Energy Inline (Meter Total)

Table 3-11 Energy Inline Shortcut Code

Function	User	Screen Number	Code	Content
Energy (No TOU, only Real- time Energy)	Inline	1	10100	System active energy
		2	10200	Phase A, B, C active energy
		3	10300	System this month total energy, system this month tariff 1 energy, system this month tariff 2 energy
		4	10400	System this month tariff 3 energy, system this month tariff 4 energy
		5	10500	System prior month total energy, system prior month tariff 1 energy, system prior month tariff 2 energy
		6	10600	System prior month tariff 3 energy, system prior month tariff 4 energy
		7	10700	Phase A this month tariff 3 energy, Phase A this month tariff 1 energy, Phase A this month tariff 2 energy

Function	User	Screen Number	Code	Content
		8	10800	Phase A this month tariff 3 energy, Phase A this month tariff 4 energy
		9	10900	Phase A prior month total energy, Phase A prior month tariff 1 energy, Phase B this month tariff 2 energy
		10	11000	Phase A prior month tariff 3 energy, Phase A prior month tariff 4 energy
		11	11100	Phase B this month total energy, Phase B this month tariff 1 energy, Phase B this month tariff 2 energy
		12	11200	Phase B this month tariff 3 energy, Phase B this month tariff 4 energy
		13	11300	Phase B prior month total energy, Phase B prior month tariff 1 energy, Phase B prior month tariff 2 energy
		14	11400	Phase B prior month tariff 3 energy, Phase B prior month tariff 4 energy
		15	11500	Phase C this month total energy, Phase C this month tariff 1 energy, Phase C this month tariff 2 energy
		16	11600	Phase C this month tariff 3 energy, Phase C this month tariff 4 energy
		17	11700	Phase C prior month total energy, Phase C prior month tariff 1 energy, Phase C prior month tariff 2 energy
		18	11800	Phase C prior month tariff 3 energy Phase C prior month tariff 4 energy
		19	11900	System reactive energy

Function	User	Screen Number	Code	Content
		20	12000	Phase A, B, C reactive energy
		21	12100	System apparent energy
		22	12200	Phase A, B, C apparent energy
Demand	1-18	1	20100	System active power demand, system reactive power demand, system apparent power demand
		2	20200	Phase A, B, C active power demand
		3	20300	Phase A real power demand prediction, Phase A real power demand peak and load time
		4	20400	Phase B real power demand prediction, Phase B real power demand peak and load time
		5	20500	Phase C real power demand prediction, Phase C real power demand peak and load time
		6	20600	Phase A, B, C reactive power demand
		7	20700	Phase A reactive power demand prediction, Phase A reactive power demand peak and load time
		8	20800	Phase B reactive power demand prediction, Phase B reactive power demand peak and load time
		9	20900	Phase C reactive power demand prediction, Phase C reactive power demand peak and load time

Function	User	Screen Number	Code	Content
		10	21000	Phase A, B, C apparent power demand
		11	21100	Phase A apparent power demand prediction, Phase A apparent power demand peak and load time
		12	21200	Phase B apparent power demand prediction, Phase B apparent power demand peak and load time
		13	21300	Phase C apparent power demand prediction, Phase C apparent power demand peak and load time
		14	21400	Phase A, B, C current demand
		15	21500	Phase A current demand prediction, Phase A current demand peak and load time
		16	21600	Phase B current demand prediction, Phase B current demand peak and load time
		17	21700	Phase C current demand prediction, Phase C current demand peak and load time
Digital Input Digital Output	DI Channel 1-8	1	30101-30108	DI status
		2	30201-30208	RO status
		3	30301-30308	DI pulse input status

Function	User	Screen Number	Code	Content
Real-time	Inline	1	40100	System active power, system reactive power, system apparent power
		2	40200	System power factor, system load type
		3	40300	Phase A, B, C active power
		4	40400	Phase A, B, C reactive power
		5	40500	Phase A, B, C apparent power
		6	40600	Phase A, B, C power factor
		7	40700	Phase A, B, C current
		8	40800	Phase A, B, C phase voltage
		9	40900	Phase A, B, C average of phase voltage
		10	41000	Phase A, B, C line voltage
		11	41100	Phase A, B, C average of line voltage
		12	41200	Voltage frequency

5. 2LL Wiring Related Shortcut Code Table :

Table 3-8 Two Phase 3 Wire Shortcut Code

Function	User	Screen Number	Code	Content
Energy	1-18	1	12101-12118	Real energy
		2	12201-12218	This month total power-sharing, this month tariff 1 energy, this month tariff 2 energy
		3	12301-12318	This month tariff 3 energy, this month tariff 4 energy
		4	12401-12418	Prior month total power sharing, prior month tariff 1 energy, prior month tariff 2 energy
		5	12501-12518	Prior month tariff 3 energy, prior month tariff 2 energy
		6	12601-12618	Reactive energy
		7	12701-12718	Apparent energy
Demand	1-18	1	22101-22118	Real power demand, reactive power demand, apparent power demand
		2	22201-22218	Real power demand prediction, real power demand peak and happening time
		3	22301-22318	Reactive power demand prediction, reactive power demand peak and happening time
		4	22401-22418	Apparent power demand prediction, apparent power demand peak and happening time
		5	22501-22518	Phase A, B, C current demand

Function	User	Screen Number	Code	Content
		6	22601-22618	Phase A current demand prediction, Phase A current demand peak and load time
		7	22701-22718	Phase B current demand prediction, Phase B current demand peak and load time
		8	22801-22818	Phase C current demand prediction, Phase C current demand peak and load time
Real-time	1-18	1	42101-42118	Real power
		2	42201-42218	Reactive power
		3	42301-42318	Apparent power
		4	42401-42418	Power factor
		5	42501-42518	Load type
		6	42601-42618	Phase A, B, C current

6. Network Wiring Related Shortcut Code Table

Table 3-8 Two Phase 3 Wire Shortcut Code

Function	User	Screen Number	Code	Content
Energy	1-18	1	12101-12118	Real energy
		2	12201-12218	Phase A+B or C+A or B+C real energy
		3	12301-12318	Reactive energy
		4	12401-12418	Phase A+B or C+A or B+C reactive energy

Function	User	Screen Number	Code	Content
		5	12501-12518	Apparent energy
		6	12601-12618	Phase A+B or C+A or B+C apparent energy
Demand	1-18	1	22101-22118	Real power demand, reactive power demand, apparent power demand
		2	22201-22218	Real power demand prediction, real power demand peak and happening time
		3	22301-22318	Reactive power demand prediction, reactive power demand peak and happening time
		4	22401-22418	Apparent power demand prediction, apparent power demand peak and happening time
		5	22501-22518	Phase A, B, C current demand
		6	22601-22618	Phase A current demand prediction, Phase A current demand peak and load time
		7	22701-22718	Phase B current demand prediction, Phase B current demand peak and load time
		8	22801-22818	Phase C current demand prediction, Phase C current demand peak and load time

Function	User	Screen Number	Code	Content
Real-Time	1-18	1	42101-42118	Total active power, total reactive power, total apparent power
		2	42201-42218	Total power factor, total load type
		3	42301-42318	Phase A+B or C+A or B+C active power
		4	42401-42418	Phase A+B or C+A or B+C reactive power
		5	42501-42518	Phase A+B or C+A or B+C apparent power
		6	42601-42618	Phase A+B or C+A or B+C power factor
		7	42701-42718	Phase A+B or C+A or B+C current

3.7 Basic Settings and Key Operation

In the second page of the main menu, use the arrow keys to navigate to **SET** and press **OK** to view the meter settings. Users will be prompted by a password screen, this can be left as the default password of **0000** or if the password has been changed enter it to view the settings.

Use the **Left** and **Right** arrow keys to move between settings. To change a setting use the **OK** button to enter edit mode, the setting will be flashing once in edit mode. To change the value of the setting press either the **Up** or **Down** buttons and press the **OK** button to confirm the setting. Once the setting is confirmed it will no longer be flashing. Pressing the **Left** and **Right** buttons at the same time will return the user back to the main menu.

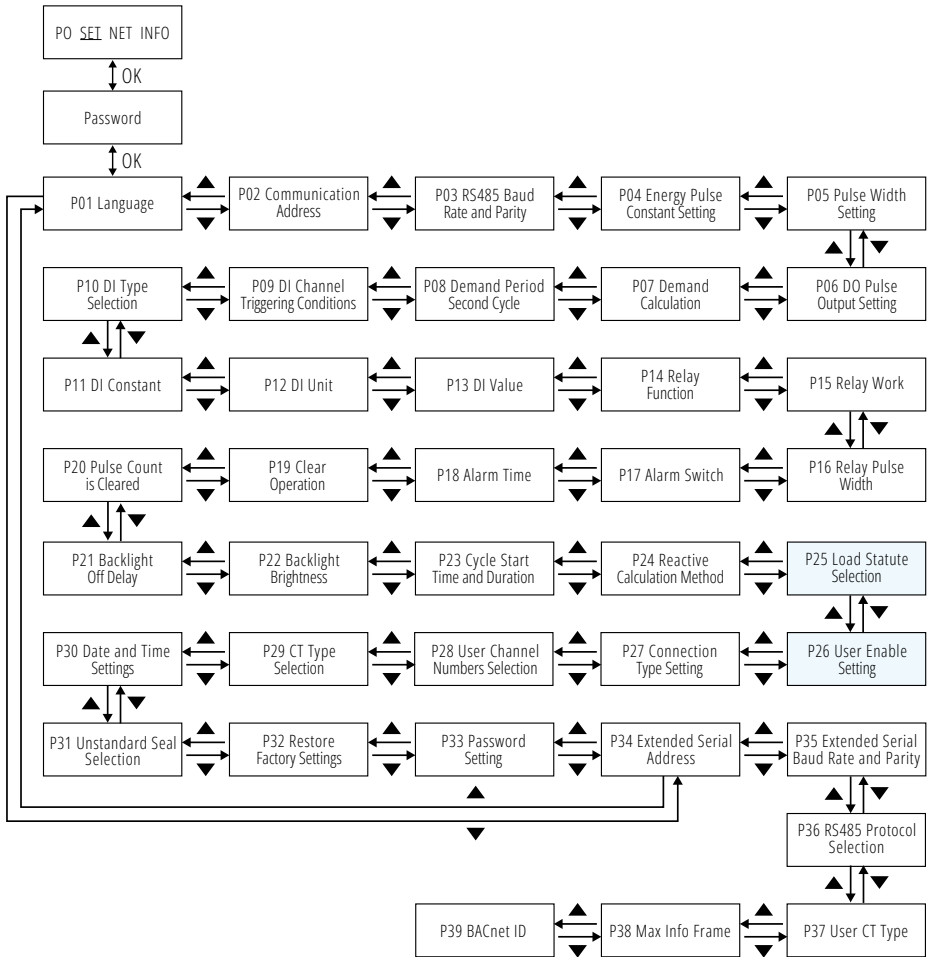

Fig. 3-20 Basic Settings

3.8 Network Settings

In the second page of the main menu use the arrow keys to navigate to **NET** and press **OK** to enter the NET settings. Users will be prompted by a password screen, this can be left as the default password of **0000** or if the password has been changed enter it to view the network settings.

Use the **Left** and **Right** arrow keys to move between settings. To change a setting use the **OK** button to enter edit mode, the setting will be flashing once in edit mode. To change the value of the setting press either the **Up** or **Down** buttons and press the **OK** button to confirm the setting. Once the setting is confirmed it will no longer be flashing. Pressing the **Left** and **Right** buttons at the same time will return the user back to the main menu.

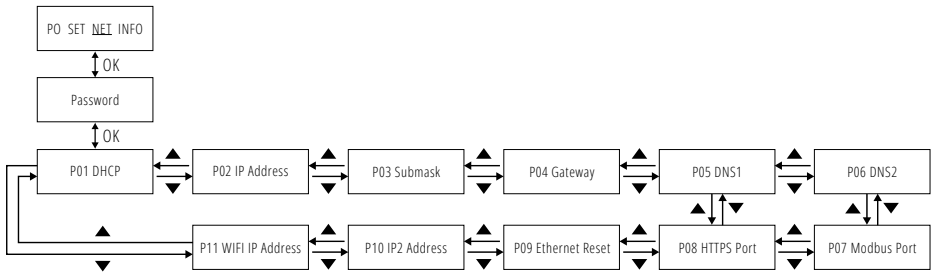

Fig. 3-21 Network Settings

P01 DHCP represents the DHCP address allocation mode setting, MANU (static IP) and AUTO (dynamic IP); P09 Network Module Reset options:

1. No Reset
2. Reset Network Module
3. Restore Default Parameters

Network settings only apply to the communications module. After network setting configuration, the communication module **needs** to be reset in order to confirm all changes.

3.9 Device Information and Key Operation

In the second page of the main menu, use the arrow keys to navigate to **INFO** and then press **OK** to view the meters device information. Use the arrow keys to scroll between pages and press the **OK** button to return to the main menu.

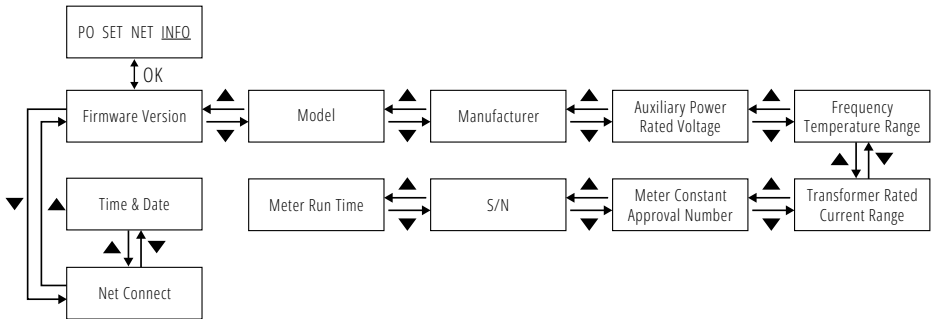

Fig. 3-22 Device Information Display

Chapter 4: Functions and Software

4.1 Introduction to Acuvue Software

4.1.1 Connecting the AcuRev 2100 to Acuvue

4.2 General Settings

4.2.1 CT ratio and Channel Mapping

4.3 Real Time Metering

4.4 Demand

4.5 Energy

4.5.1 Time of Use (TOU)

4.6 IO Functions

4.6.1 Digital Input

4.6.2 Relay Output

4.6.3 Digital Output

4.7 Alarm

4.8 System Event Log

4.9 Data Log

4.9.1 Reading the Data Log

4.10 Seal Button (B1) Function

4.10.1 How to use the Seal Button (B1)

4.11 Device Information

Chapter 4: Functions and Software

4.1 Introduction to Acuvview Software

The AcuRev 2100 has a wide range of measurement parameters with power quality detection, alarm and other functions. We have designed special software to use and configure the AcuRev 2100 meter. This chapter will be combined with the software interface for the functional explanation.

This chapter introduces AcuRev 2100 Software (Acuvview). This software can be downloaded for free from our website. (www.accuenergy.com)

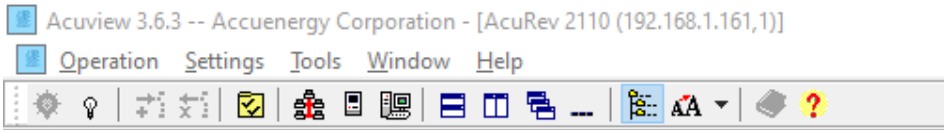

Figure 4-1 AcuRev 2100 Software

4.1.1 Connecting the AcuRev 2100 to Acuvview

Users can connect to the software either the RS485 port on the meter or by Ethernet/WIFI. When connecting to the software via RS485 user will need to use an RS485 to USB converter in order to connect.

NOTE: For more information on Ethernet/WIFI communication refer to the *AcuRev 2100-WEB manual*.

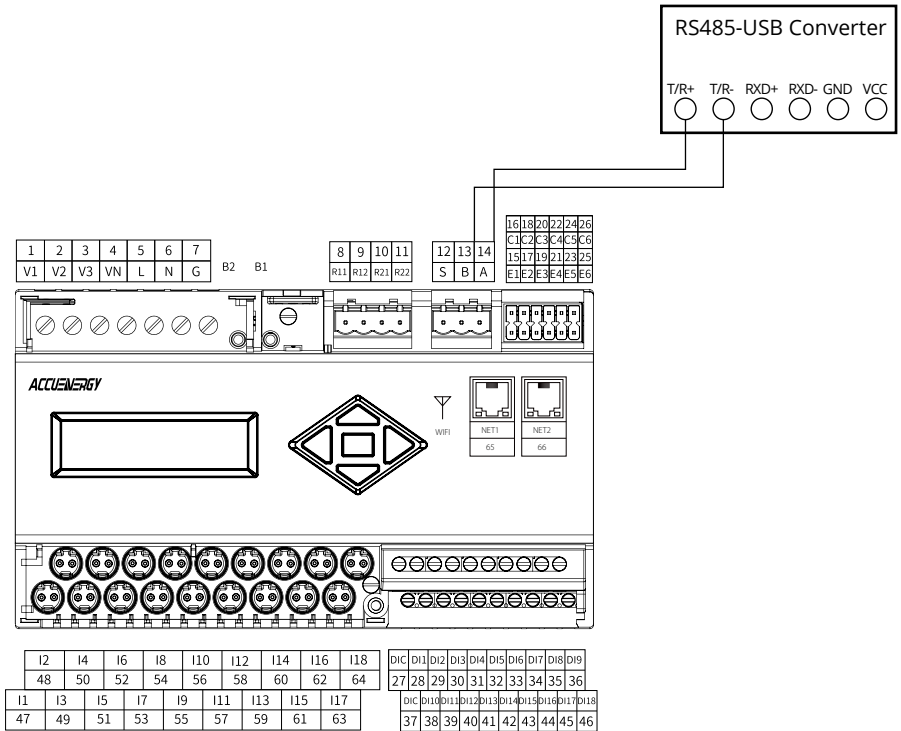

Figure 4-2 AcuRev 2100 RS485-USB converter connection

Two wires should be used in connecting the USB-RS485 converter to the meter:

- T/R+ from the converter to 'A'(14) on the meter
- T/R- from the converter to 'B'(15) on the meter

The default communication settings on the AcuRev 2100 are:

- Device Address: 1
- Baud Rate: 19200
- Parity: Non1 (No parity, 1 stop bit)

Steps to connect to the software:

1. Open the Acuvision software, users will be prompted to enter in the connection settings. The COM port can be confirmed in the Device Manager of the computer. Click on OK.

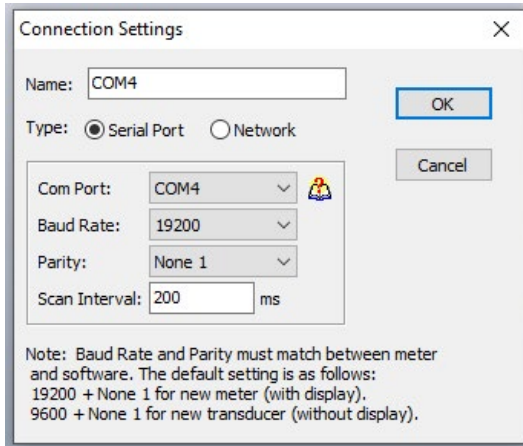

Figure 4-3 Connection Setting Configuration

2. Add device window will appear, select AcuRev 2100, select the connection created in the previous step, enter in the device address and enter in a description for the device. Click on OK.

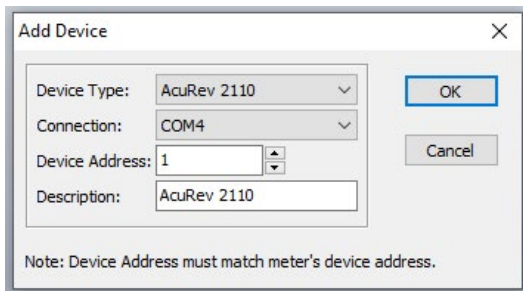

Figure 4-4 Add Device page on Acuvision

3. The meter will automatically connect, if it does not click on the Operation menu and click on Connect.

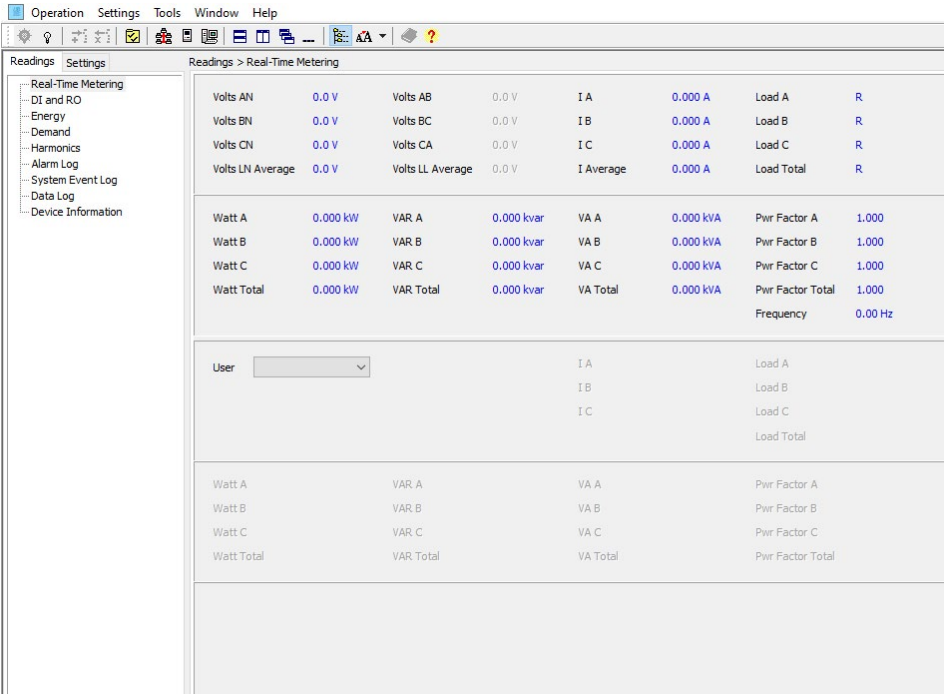

Figure 4-5 AcuRev 2100 connected to Acuvue

4.2 General Settings

Users can configure the general setting of the AcuRev 2100 meter from the Acuvue software, some of these settings include the CT ratio/mapping, communication, and password.

To access the settings from Acuvue click on the **Settings** tab located on the left panel of the software and select **General**. Users can change the settings for the AcuRev 2100 and use the **Update Device** button at the bottom of the page to confirm the settings.

<p>Security</p> <p>Change Password</p>		<p>Communication</p> <p>Address <input type="text" value="1"/></p> <p>Address 2 <input type="text" value="1"/></p> <p>Net Module Type <input type="text" value="WiFi"/></p> <p>Baud Rate <input type="text" value="19200"/> bps</p> <p>Parity <input type="text" value="None1"/></p> <p>Baud Rate 2 <input type="text" value="38400"/> bps</p> <p>Parity 2 <input type="text" value="None1"/></p>	
<p>Channel of Energy Pulse</p> <p>DO1 <input type="text" value="Ep (CH301/201)"/></p> <p>DO2 <input type="text" value="Ep (CH302/202)"/></p> <p>DO3 <input type="text" value="Ep (CH303/203)"/></p> <p>DO4 <input type="text" value="Ep (CH304/204)"/></p> <p>DO5 <input type="text" value="Ep (CH305/205)"/></p> <p>DO6 <input type="text" value="Ep (CH306/206)"/></p>		<p>Energy Pulse</p> <p>Const <input type="text" value="50000"/></p> <p>Width <input type="text" value="80"/> ms</p> <p>Rated Voltage</p> <p><input type="text" value="400"/> V</p>	
<p>VAR Calculation Method</p> <p><input type="radio"/> Method 1 (True)</p> <p><input checked="" type="radio"/> Method 2 (Generalized)</p>		<p>VAR/PF Convention</p> <p><input checked="" type="radio"/> IEC</p> <p><input type="radio"/> IEEE</p>	
<p>Display</p> <p>Auto-cycle Start Time <input type="text" value="5"/> min</p> <p>Auto-cycle Show Time <input type="text" value="10"/> S</p>		<p>DI Synchronous Demand</p> <p>DI Trigger Condition <input type="text" value="Do not trigger"/></p> <p>DI Sync-Source <input type="text" value="DI1"/></p> <p>Demand Type</p> <p><input type="text" value="Rolling Window Demand"/></p>	
<p>Non-Standard Seal Options of Seals</p> <p><input type="checkbox"/> Device Run-Time</p> <p><input type="checkbox"/> Device Clock</p> <p><input type="checkbox"/> Device Clock + TOU Related</p>		<p><input type="checkbox"/> Communication Parameters</p> <p><input type="checkbox"/> Network Parameters</p> <p><input type="checkbox"/> RO Related</p>	
<p>Communication Channel 1</p> <p>Protocol <input type="text" value="Modbus"/></p> <p>Node Address <input type="text" value="1"/></p> <p>Max Info Frames <input type="text" value="10"/></p> <p>Baud Rate <input type="text" value="19200"/> bps</p> <p>BACnet ID <input type="text" value="1"/></p>			

Figure 4-6 General Settings

The General Settings page is divided into the following sections.

Security

Change Password: Users can change the meter password using this setting. The range is 0000-9999.

Communication

- Address: Users can configure the Modbus address for the device, this refers to the Modbus address via RS485. The range is from 1-247, the default address is 1.
- Address 2: Users can configure the Modbus TCP address for the meter, the default is 1 and the range is 1-247.
- Baud Rate: Users can configure the baud rate for the RS485 port, the range is 1200-115200 bps. The default is 19200.
- Parity: Users can configure the parity here, the default is None 1 (No parity, 1 stop bit)

NOTE: *Baud rate 2 and Parity 2 should not be changed from 38400 and None1, these settings are required in order for successful communication between the meter and communications module.*

Demand

- Demand Type: There are 4 types of demand that the user can select. The default method is Sliding Window.
 - Fixed Window: The demand is calculated based on selecting the calculation period between 1-30min. The meter will calculate and update the demand values at the end of each calculation period.
 - Sliding Window: The demand is calculated by selecting the calculation period between 1-30 min. The meter will average the energy accumulated within this period of time and the demand value is updated every minute.
 - Thermal: The demand is calculated based on thermal response, used in thermal demand meters. This method uses a sliding window to update the demand value at the end of each calculation period.
 - Rolling Window: The demand is based on selecting a calculation period between 1-30 min, a sub interval(Demand Calculation Slip Time) and the demand value is updated at each sub interval. The sub interval must be a factor of the calculation period. For example, with a calculation period of 15 minutes, the sub interval can be configured as 5 minutes.

VAR Calculation/VAR Convention

- VAR Calculation Method: Can be either True or Generalized.
 - True: Uses the Budeanu Concept to calculate the True reactive power. This method

generally takes the harmonic components to do the calculation instead of using the power vector triangle method.

- Generalized: Uses Fryze's concept to calculate the Generalized reactive power. This method separates instantaneous current into two components, active and reactive currents.
- VAR/PF Convention: Users can select the convention as either IEC or IEEE

Energy Pulse

- Channel of Energy Pulse: Users can select which user/input channel energy corresponds to the Digital Output channels.
- Pulse Constant: Used to represent the amount of pulses that represents 1kWh. The range is 1-60000, the default is 50000.
- Pulse Width: Users can configure the pulse width, the range is 20-100ms, the default is 80ms.

DI Synchronous Demand

- DI Trigger Condition: Users can synchronize the Demand with the DI, and can select the condition in which to synchronize. The options are
 - No Trigger
 - Trigger by rising edge
 - Trigger by falling edge
 - Trigger by changes
- DI Sync-Source: DI Synchronization source can set as DI1-DI8.

Rated Voltage

Rated Voltage: This rated voltage is the rating used for the Alarm setting. The default is 220V and the range is 120-600VLL.

Communication Channel 1

Protocol: Modbus or BACnet MS/TP

If BACnet MS/TP is chosen, users can configure the settings:

- Node Address, the range is 0 to 127. The default is 1.
- Baud Rate, the range is 1200 to 115200. The default is 19200.
- Max Info Frames, the range is 1 to 255. The default is 10.
- BACnet ID, the range is 1 to 4194303. The default is 1.

4.2.1 CT ratio and Channel Mapping

The CT ratio must be configured in the AcuRev 2100 meter in order for it to correctly read current measurements. Users can configure the CT settings in the software by clicking on **User and CT** under the **Settings** tab on the left panel of Acuvue.

In the CT model section users can enter in the primary rating of the CTs being used with the meter. The range is 5-2000A and the default setting is 20A.

Users can also map the channel names in this section where the user name can be customized. The user names can support up to 6 characters (ASCII).

Number 101-118 refers to the physical single-phase channel 1-18.

Number 301/201- 306/206 refers to three-phase user channels 1 to 6.

The enable display section allows users to enable or disable that particular channel on the LCD display of the meter. For example, the first one username Jack01 is set as 301/201 meaning it is the first three phase circuit (using channels 1,2,3).

NOTE: After any change in configuration users must click on "Update Device" in order to send and save the settings to the meter.

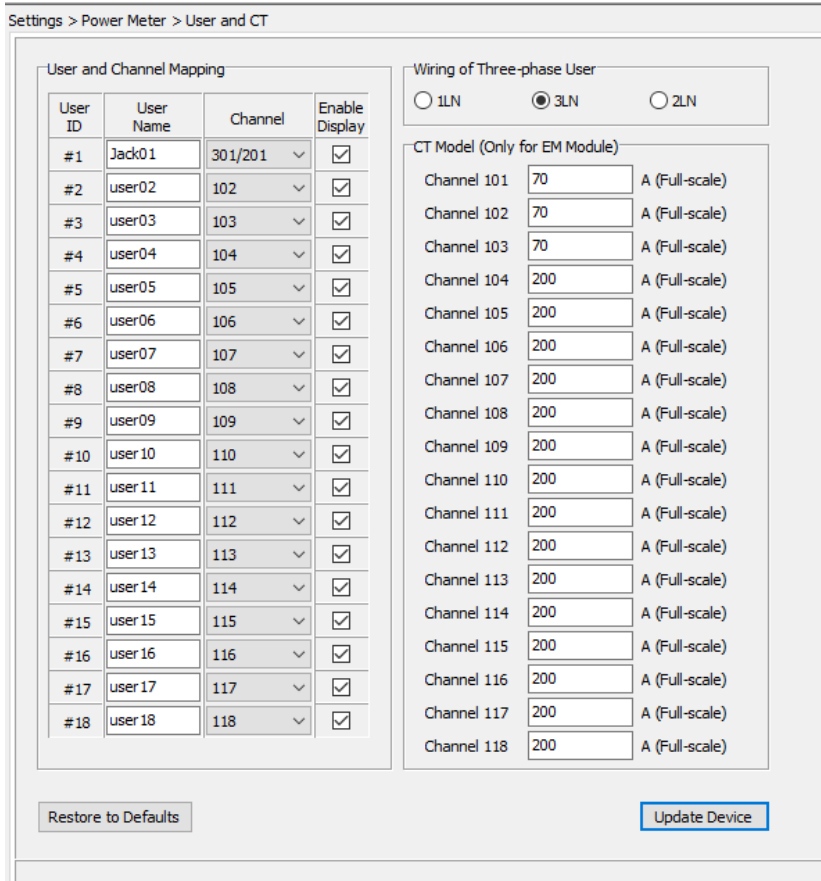

Figure 4-7 User and Channel Mapping

4.3 Real Time Metering

The AcuRev 2100 supports real time parameters such as voltage, current and power. Voltage includes line voltage, phase voltage, current for each channel and inline (total of all circuits), power (active, reactive, apparent) and power factor for each channel and inline values. Depending on the wiring mode configured in the meter the view on Acuvision will be different.

The real time values can be seen on the software by clicking on **Real-Time Metering** under the **Readings** tab on the left panel of the software. The figure below shows the real time metering section when the wiring is set for 3LN.

The top portion of the page displays the meter inline values, meaning the totals and averages for all circuits connected to the meter. The **User** section at the bottom of the page allows users to view the real time metering for each channel or circuit connected to the meter.

Readings > Real-Time Metering

Volts AN	0.0 V	Volts AB	10.0 V	I A	0.000 A	Load A	R
Volts BN	0.0 V	Volts BC	0.0 V	I B	0.000 A	Load B	R
Volts CN	0.0 V	Volts CA	0.0 V	I C	0.000 A	Load C	R
Volts LN Average	0.0 V	Volts LL Average	3.3 V	I Average	0.000 A	Load Total	R
Watt A	0.000 kW	VAR A	0.000 kvar	VA A	0.000 kVA	Pwr Factor A	1.000
Watt B	0.000 kW	VAR B	0.000 kvar	VA B	0.000 kVA	Pwr Factor B	1.000
Watt C	0.000 kW	VAR C	0.000 kvar	VA C	0.000 kVA	Pwr Factor C	1.000
Watt Total	0.000 kW	VAR Total	0.000 kvar	VA Total	0.000 kVA	Pwr Factor Total	1.000
						Frequency	0.00 Hz
User	Jack01 (CH301)			I A	0.000 A	Load A	R
				I B	0.000 A	Load B	R
				I C	0.000 A	Load C	R
						Load Total	R
Watt A	0.000 kW	VAR A	0.000 kvar	VA A	0.000 kVA	Pwr Factor A	1.000
Watt B	0.000 kW	VAR B	0.000 kvar	VA B	0.000 kVA	Pwr Factor B	1.000
Watt C	0.000 kW	VAR C	0.000 kvar	VA C	0.000 kVA	Pwr Factor C	1.000
Watt Total	0.000 kW	VAR Total	0.000 kvar	VA Total	0.000 kVA	Pwr Factor Total	1.000

Figure 4-8 Real Time Metering

4.4 Demand

The meter demand readings can be found under the **Readings** tab by selecting **Demand**. This page displays the Demand, Max Demand, Max Demand Time, Demand Prediction (update per second) of the power, reactive power, apparent power and current. The page is divided into two sections where the top part of the page shows the total demand readings for all circuits/channels connected to the meter. The bottom half of the page is where users can select the

individual channels/circuits to view the demand.

AcuRev 2100 supports Demand Synchronization, where the demand is synchronized with the Digital Input. The demand cycle or the end of the sub-cycle can be output as DO. This can be configured in the general settings sections.

Users can reset the demand in this section by using the **Clear Demand** button.

Readings > Demand

Demand	Current	Maximum	Time Stamp	Prediction
I A	0.000 A	548.149 A	2020-03-27 17:04:08	0.000 A
I B	0.000 A	93.617 A	2020-06-25 12:23:40	0.000 A
I C	0.000 A	93.589 A	2020-06-25 12:23:40	0.000 A
Watt A	0.000 kW	56.217 kW	2020-03-26 16:27:13	0.000 kW
Watt B	0.000 kW	11.021 kW	2020-06-25 12:22:40	0.000 kW
Watt C	0.000 kW	10.991 kW	2020-06-25 12:22:40	0.000 kW
Watt Total	0.000 kW	61.983 kW	2020-03-26 16:27:13	0.000 kW
VAR A	0.000 kvar	-28.045 kvar	2020-03-27 15:29:55	0.000 kvar
VAR B	0.000 kvar	-1.447 kvar	2020-03-27 16:54:06	0.000 kvar
VAR C	0.000 kvar	-1.442 kvar	2020-03-27 16:37:04	0.000 kvar
VAR Total	0.000 kvar	-30.928 kvar	2020-03-27 15:29:55	0.000 kvar
VA A	0.000 kVA	56.304 kVA	2020-03-26 16:29:13	0.000 kVA
VA B	0.000 kVA	11.249 kVA	2020-06-25 12:22:40	0.000 kVA
VA C	0.000 kVA	11.240 kVA	2020-06-25 12:22:40	0.000 kVA
VA Total	0.000 kVA	62.070 kVA	2020-03-26 16:29:13	0.000 kVA

User: Jack01 (CH301)

Demand	Current	Maximum	Time Stamp	Prediction
I A	0.000 A	121.187 A	2020-06-25 12:22:40	0.000 A
I B	0.000 A	93.617 A	2020-06-25 12:23:40	0.000 A
I C	0.000 A	93.589 A	2020-06-25 12:23:40	0.000 A
Watt A	0.000 kW	12.342 kW	2020-06-25 12:22:40	0.000 kW
Watt B	0.000 kW	11.021 kW	2020-06-25 12:22:40	0.000 kW
Watt C	0.000 kW	10.991 kW	2020-06-25 12:22:40	0.000 kW
Watt Total	0.000 kW	34.354 kW	2020-06-25 12:22:40	0.000 kW
VAR A	0.000 kvar	-0.690 kvar	2020-06-25 12:22:40	0.000 kvar
VAR B	0.000 kvar	0.000 kvar	2020-06-25 12:14:39	0.000 kvar
VAR C	0.000 kvar	0.000 kvar	2020-06-25 12:14:39	0.000 kvar
VAR Total	0.000 kvar	-0.689 kvar	2020-06-25 12:22:40	0.000 kvar
VA A	0.000 kVA	12.766 kVA	2020-06-25 12:23:40	0.000 kVA
VA B	0.000 kVA	11.249 kVA	2020-06-25 12:22:40	0.000 kVA
VA C	0.000 kVA	11.240 kVA	2020-06-25 12:22:40	0.000 kVA
VA Total	0.000 kVA	35.255 kVA	2020-06-25 12:23:40	0.000 kVA

Figure 4-9 Demand Readings

4.5 Energy

From the Acuvue software users can view the energy readings for the meter. The top portion of the page provides the total energy consumed energy for all circuits connected to the meter. This includes the real, reactive, and apparent energy. The AcuRev 2100 also supports a TOU function where the energy can be divided into different tariff groups. The TOU provides the current energy TOU as well as the prior month TOU.

The bottom portion of the energy page allows users to view the energy consumption for each individual circuit/channel. The energy value is read and write, meaning users can edit the value of the energy from this section. To edit the value of the energy click on the value of the energy parameter and enter in the new value. Users can reset the meter energy by using the **Clear Energy** button.



Figure 4-10 Energy Readings

4.5.1 Time of Use (TOU)

The AcuRev 2100 supports a time-of-use function that allows users to assign up to 4 different tariffs to different time periods within the day according to their billing requirements. The meter will calculate and accumulate energy to each of the different tariffs configured based on the meters time/date and TOU settings. The TOU function allows users to view the current

month usage as well as the previous months usage.

The Time of use (TOU) must be configured from the Acuvview software by selecting **TOU** under the **Settings** tab.

Figure 4-11 TOU Settings page

TOU Settings

- Season: The maximum season number is 14. Each season will operate on the TOU Schedule it is configured to.
- Schedule: The maximum schedule number is 8, where this parameter determines the number of TOU schedules available for the TOU calendar setting. Each schedule can be

divided up into time segments and assigned a tariff.

- **Segment:** A segment is included in a schedule where each schedule can have up to a maximum of 14 time segments. Each segment is assigned a tariff.
- **Tariff:** The AcuRev 2100 supports up to 4 tariffs in the TOU function. The range is 1-4 for this setting where 1 means 1 tariff and 4 means all 4 tariffs are used.
 1. Sharp
 2. Sharp, Peak
 3. Sharp, Peak, Valley
 4. Sharp, Peak, Valley, Normal
- **Weekend:** Allows users to assign how many days are considered weekend days. The range is 1-8 for this setting.
- **Holiday:** A maximum of 30 holidays can be programmed to the TOU calendar. If the holiday setting parameter is set as 3, the first 3 slots of the holiday schedule must be set, otherwise, it will be considered as an invalid input (TOU function will be disabled). If the weekend and public holidays are overlapped, the public holiday overrides the weekend setting, the holiday has a higher priority.
- **Fault Status Word:** Will display a hex word if there is an error present in the TOU settings. This word should read 0 if all settings are correct.

Billing Mode

- **Monthly Billing Mode:** Users can select the monthly billing according to their billing requirement, where the billing mode can be at the end of every month or a specific time and date. The format for the time method is DD HH:MM:SS.
 - In this section users can enable the TOU function in the Acuvim II meter by checking the box from the software. Users also have the option to restore the TOU setting back to its default settings from this section.

Daylight saving time (DST):

The AcuRev 2100 meter can adjust for the Daylight Savings Time. The DST can then be selected to follow one of two formats:

1. **Fixed date option** - If you choose a fixed date option, you set the format according to a fixed date for the DST switch. The format is Month/ Day/ Hour/ Minute/ adjusted time (in minutes).

2. **Non-Fixed date option** - If you choose the non-fixed option, DST will be implemented by which day of which week is selected. The format is Month/ Which Day/ Which week/ Hour/ Minute/ adjusted time (in minutes).

TOU Seasons Settings

Enter the start date into the TOU season table slot following format **MM-DD-ID**.

- MM stands for month (range is from 1 to 12)
- DD stands for date/day (range is from 1 to 31)
- ID represents the TOU schedule to run (range is from 1-14)

The dates should be organized so that they are in sequence according to the calendar year (the earlier date comes first and the later date comes last). For example, if 2 seasons are selected, the date parameters are March 31 and November 4, and TOU schedule 01, 02 will be used respectively, the first TOU season table slot shall enter 03-31 01, and the second slot shall enter 11-04 02. With this configuration the first season would be from March 31st to November 4th, and the second season would be from November 4th to March 31st.

TOU Schedule Settings

Similar to TOU season format, enter the start time into the TOU schedule table slot following this format HH: MM ID:

- HH stands for hour (range is in 24 hour format, 0 to 24 hours)
- MM stands for minutes (range is from 00 to 60 minutes)
- ID stands for tariffs (available from 00 to 03).

The time should be organized according to the hour sequence. For example, if 3 segments are configured, timing parameters are 01:00, 15:30, 22:45, the order of the 3 segments should be one of the following: 01:00, 15:30, 22:45 or 15:30, 22:45, 01:00 or 22:45, 01:00, 15:30. Entering time information in a wrong sequence (for example, entering 15:30, 01:00, 22:45) is considered as an invalid operation and the TOU function will be disabled.

In the figure below TOU Schedule #1 can be described as follows:

- From 12AM to 11AM all energy consumed will be accumulate under the Sharp Tariff (Tariff ID 1)
- From 11AM to 5PM all energy consumed will be accumulated under the Peak Tariff (Tariff ID 2)
- From 5PM to 6PM all energy consumed will be accumulated under the Valley Tariff (Tariff ID 3)
- From 6PM to 8PM all energy consumed will be accumulated under the Normal Tariff (Tariff ID 4)
- From 8PM to 11AM all energy consumed will be accumulated under the Sharp Tariff (Tariff ID 1)

TOU Schedule #1						
00:00 01	11:00 02	17:00 03	18:00 04	22:00 01	00:00 00	00:00 00
00:00 00	00:00 00	00:00 00	00:00 00	00:00 00	00:00 00	00:00 00
TOU Schedule #2						
07:00 04	10:00 02	11:00 01	00:00 01	00:00 01	00:00 01	00:00 01
00:00 01	00:00 01	00:00 00	00:00 00	00:00 00	00:00 00	00:00 00
TOU Schedule #3						
00:00 00	00:00 00	00:00 00	00:00 00	00:00 00	00:00 00	00:00 00
00:00 00	00:00 00	00:00 00	00:00 00	00:00 00	00:00 00	00:00 00
TOU Schedule #4						
00:00 00	00:00 00	00:00 00	00:00 00	00:00 00	00:00 00	00:00 00
00:00 00	00:00 00	00:00 00	00:00 00	00:00 00	00:00 00	00:00 00

Figure 4-12 TOU Schedule Configuration

Holidays Settings

The AcuRev 2100 supports holiday configuration within its TOU function, where a maximum of 30 holidays can be programmed to the TOU calendar. Users can program the amount of holidays within the TOU calendar by entering a number from 0-30 on the holiday setting in the General section of the TOU settings. For example if the holiday setting parameter is set as 3, the first 3 slots of the holiday schedule must be set, otherwise, it will be considered as an invalid input (TOU function will be disabled).

To configure the Holiday timing users must set the the holiday schedule, which uses the same format as the TOU seasons “MMDD ID”. Users can select which TOU schedule to be used for the holiday. The dates of the holiday schedule do not need to be organized in sequential order (i.e. the first slot can be January 1, the second slot can be December 26 and the third slot can be December 25).

Ten Year Holiday Setting

Users can preset holidays for the upcoming 10 years via the meter software. Since the holiday dates change as the years go by this feature allows users to preset the dates. Select **Ten Year Holiday** under the **Settings** tab in order to view the settings.

The holiday format MM-DD ID, where the ID number is the schedule number to use for that holiday. User can input all the holidays in the **Make Holiday Settings (10 year)** option located on the bottom of the page. Users can enter in the holiday dates, holiday code and Schedule

setting number. The holiday codes are defined as follows:

- 0 - Holiday only occurs once
- 1 - Holiday occurs on the same date each year
- 2 - Holiday occurs on the first Sunday on or after the date entered
- 3 - Holiday occurs on the first Monday on or after the date entered
- 4 - Holiday occurs on the first Thursday on or after the date entered
- 5 - Holiday moved from Sunday to Monday
- 6 - Holiday moved from Saturday to Friday or Sunday to Monday

TOU Holiday Code Definition ✕

Holiday Sched #	Actual Date (MM/DD/YYYY)	Holiday Code	Sched Setting	Holiday Sched #	Actual Date (MM/DD/YYYY)	Holiday Code	Sched Setting	Holiday Sched #	Actual Date (MM/DD/YYYY)	Holiday Code	Sched Setting
1.	12/25/2020	1	1	18.	00/00/2000	0	1	35.	00/00/2000	0	1
2.	05/24/2020	2	1	19.	00/00/2000	0	1	36.	00/00/2000	0	1
3.	00/00/2000	0	1	20.	00/00/2000	0	1	37.	00/00/2000	0	1
4.	00/00/2000	0	1	21.	00/00/2000	0	1	38.	00/00/2000	0	1
5.	00/00/2000	0	1	22.	00/00/2000	0	1	39.	00/00/2000	0	1
6.	00/00/2000	0	1	23.	00/00/2000	0	1	40.	00/00/2000	0	1
7.	00/00/2000	0	1	24.	00/00/2000	0	1	41.	00/00/2000	0	1
8.	00/00/2000	0	1	25.	00/00/2000	0	1	42.	00/00/2000	0	1
9.	00/00/2000	0	1	26.	00/00/2000	0	1	43.	00/00/2000	0	1
10.	00/00/2000	0	1	27.	00/00/2000	0	1	44.	00/00/2000	0	1
11.	00/00/2000	0	1	28.	00/00/2000	0	1	45.	00/00/2000	0	1
12.	00/00/2000	0	1	29.	00/00/2000	0	1	46.	00/00/2000	0	1
13.	00/00/2000	0	1	30.	00/00/2000	0	1	47.	00/00/2000	0	1
14.	00/00/2000	0	1	31.	00/00/2000	0	1	48.	00/00/2000	0	1
15.	00/00/2000	0	1	32.	00/00/2000	0	1	49.	00/00/2000	0	1
16.	00/00/2000	0	1	33.	00/00/2000	0	1	50.	00/00/2000	0	1
17.	00/00/2000	0	1	34.	00/00/2000	0	1				

Holiday code explain:

- 0 - Holiday only occurs once
- 1 - Holiday same date each year
- 2 - First sunday on or after date

- 3 - First monday on or after date
- 4 - First thursday on or after date
- 5 - Holiday moved from Sun. to Mon.
- 6 - Holiday moved from Sat. to Fri. or Sun. to Mon.

Save Load Generate Close

Figure 4-13 TOU Holiday Code Definition

Once all the holidays are entered in the TOU Holiday Code definition users can click on **Generate** to automatically populate and load all the holidays in the 10 year holiday settings. If the current year of the meter does not fall into the Ten year Holiday setting, it remains as the current TOU settings.

NOTE: The holiday schedule has the highest priority among all the schedules. The weekend schedule's priority is followed by the Holiday schedule. When the holiday schedule is not enabled, the weekend schedule has the highest priority, overriding the normal (weekday) schedule.

Settings > Power Meter > Ten Years Holiday

Enable Holidays Years Settings

Start Year Ending Year

1st Year Holidays

1	01-01 1	02-01 2	03-01 3	04-01 4	05-01 5	00-00 00	6
7	00-00 00	00-00 00	00-00 00	00-00 00	00-00 00	00-00 00	12
13	00-00 00	00-00 00	00-00 00	00-00 00	00-00 00	00-00 00	18
19	00-00 00	00-00 00	00-00 00	00-00 00	00-00 00	00-00 00	24
25	00-00 00	00-00 00	00-00 00	00-00 00	00-00 00	00-00 00	30

Settings Year Holiday Number

2nd Year Holidays

1	01-01 1	02-01 2	03-01 3	04-01 4	05-01 5	06-01 6	6
7	07-01 7	08-01 8	09-01 9	10-01 10	00-00 00	00-00 00	12
13	00-00 00	00-00 00	00-00 00	00-00 00	00-00 00	00-00 00	18
19	00-00 00	00-00 00	00-00 00	00-00 00	00-00 00	00-00 00	24
25	00-00 00	00-00 00	00-00 00	00-00 00	00-00 00	00-00 00	30

Figure 4-14 Ten Year Holiday Configuration

4.6 IO Functions

AcuRev 2100 has 2 Relay Outputs (RO), 18 Digital Inputs (DI) and 6 Digital Outputs (DO). To configure the IO setting on the meter click on **DI, RO and Event** under the **Settings** tab on the left panel of Acuviv. From this page users can configure the Digital Input and Relay Output settings.

4.6.1 Digital Input

The AcuRev 2100 supports two Digital Input mode, Digital Status mode and Pulse Counter mode.

By default the digital input mode is configured for digital status mode where the status can be either ON/OFF, this is represented by **State** on the Acuvue software. The Digital Input is a dry contact meaning a voltage is required to change the status of the DI. When the DI detects a sufficient voltage input the status will be ON, otherwise the status will remain as OFF.

DI Ratings:

- Input Style: Dry Contact
- Input Current (Max): 2mA
- Input Voltage Range: 15-30Vdc
- Start Voltage: 12V
- Stop Voltage: 10V
- Pulse Frequency (Max): 100Hz, 50% Duty Cycle

Users can configure the DI as Pulse Counter under the DI type section in the Acuvue software. Once the mode is changed to **Counter** user can configure how many pulses equals one count on the meter. For example in figure 4-15 below DI1 is configured for 10 pulses to equal 1 count.

Users can also configure the scaling of the DI count, for example in figure 4-15 below DI1 is configured for 1 count to equal 0.50 m³. The DI unit available to configure from Acuvue are **t** (tonne), **m³** (cubic meters), **kWh** (energy), **RMB** (Renminbi), and **\$** (dollar).

Settings > Power Meter > DI, RO and Event

DI Type							
DI1	Counter	10	Pulse = 1	1 Unit =	0.50	m3	Clear DI1
DI2	Counter	100	Pulse = 1	1 Unit =	1.00	kWh	Clear DI2
DI3	Counter	1	Pulse = 1	1 Unit =	1.00	RMB	Clear DI3
DI4	Counter	1	Pulse = 1	1 Unit =	1.00	\$	Clear DI4
DI5	Counter	1	Pulse = 1	1 Unit =	1.00	t	Clear DI5
DI6	Counter	1	Pulse = 1	1 Unit =	1.00	t	Clear DI6
DI7	State	1	Pulse = 1	1 Unit =	1.00	t	Clear DI7
DI8	State	1	Pulse = 1	1 Unit =	1.00	t	Clear DI8
DI9	State	1	Pulse = 1	1 Unit =	1.00	t	Clear DI9
DI10	State	1	Pulse = 1	1 Unit =	1.00	t	Clear DI10
DI11	State	1	Pulse = 1	1 Unit =	1.00	t	Clear DI11
DI12	State	1	Pulse = 1	1 Unit =	1.00	t	Clear DI12
DI13	Counter	1	Pulse = 1	1 Unit =	1.00	t	Clear DI13
DI14	Counter	1	Pulse = 1	1 Unit =	1.00	t	Clear DI14
DI15	Counter	1	Pulse = 1	1 Unit =	1.00	t	Clear DI15
DI16	Counter	1	Pulse = 1	1 Unit =	1.00	t	Clear DI16
DI17	Counter	1	Pulse = 1	1 Unit =	1.00	t	Clear DI17
DI18	Counter	2	Pulse = 1	1 Unit =	1.00	t	Clear DI18

Figure 4-15 Digital Input Settings

To view the DI pulse count or DI status click on **DI and RO** under the **Readings** tab on the the left panel of Acuviv.

DI 1: 8	4.00 m3	DI 2: 2	2.00 kWh	DI 3: 3	3.00 RMB	DI 4: 4	4.00 \$
DI 5: 5	5.00 t	DI 6: 6	6.00 t	DI 7: OFF		DI 8: OFF	
DI 9: OFF		DI 10: OFF		DI 11: OFF		DI 12: OFF	
DI 13: 4	0.00 t	DI 14: 18	0.00 t	DI 15: 16	0.00 t	DI 16: 16	0.00 t
DI 17: 19	0.00 t	DI 18: 20	0.00 t				

Figure 4-16 DI Readings

4.6.2 Relay Output

The relay output has two modes that it can operate as in the AcuRev 2100, either control or alarm mode.

1. Control Mode: Allows users to manually control relay ON/OFF.
 - Momentary Mode: Allows users to manually turn on relay for a certain time period. The time can be configured from 50-3000ms.
2. Alarm Mode: Users can configure the over/under alarm to trigger the relay output. Users can also use the system event alarm to trigger the relay output in this mode.

There are 12 types of system event alarms that users can trigger the relay with.

1. Reset
2. DI Synchronization Demand
3. Command Synchronization Demand
4. Reset energy
5. Reset Device Run Time
6. Reset Battery Run Time
7. Modify System Parameters
8. Set Initial Energy
9. Modify TOU Settings
10. Modify System Clock
11. Reversed Power Direction
12. Reset DI Pulse Count

Users can configure and enable these events to trigger the relay. The over/under alarms will be explained in a later section of the manual.

The relay alarm drive output time ranges can be configured on this page also, it ranges from 1~60000s (how long will it take to turn off the output by itself).

RO Type

RO1 Alarm ▾

RO2 Relay Control ▾

RO Output Mode

RO1 Momentary ▾

RO2 Momentary ▾

RO Pulse Width 3000 ms

System Event Alarm	Enable	Output
Reset	<input type="checkbox"/>	Relay 1 ▾
DI Synchronization Demand	<input type="checkbox"/>	Relay 1 ▾
Command Synchronization Demand	<input type="checkbox"/>	Relay 1 ▾
Reset Energy	<input type="checkbox"/>	Relay 1 ▾
Reset Device Run-Time	<input type="checkbox"/>	Relay 1 ▾
Reset Battery Run-Time	<input type="checkbox"/>	Relay 1 ▾
Modify System Parameters	<input type="checkbox"/>	Relay 1 ▾
Set Initial Energy	<input type="checkbox"/>	Relay 1 ▾
Modify TOU Settings	<input type="checkbox"/>	Relay 1 ▾
Modify Clock	<input type="checkbox"/>	Relay 1 ▾
Reverse Power	<input type="checkbox"/>	Relay 1 ▾
Reset DI Pulse Counter	<input type="checkbox"/>	Relay 1 ▾

RO Alarm Output Time 60 S

Update Device

Figure 4-17 Relay Output Settings

Users can view the status of the relay on the **DI and RO** page under the **Readings** tab on Acuviv. If the relay is configured for relay control mode users can manually turn ON/OFF the relay by clicking on the **Control** button. If in alarm mode this function is blocked on the software.

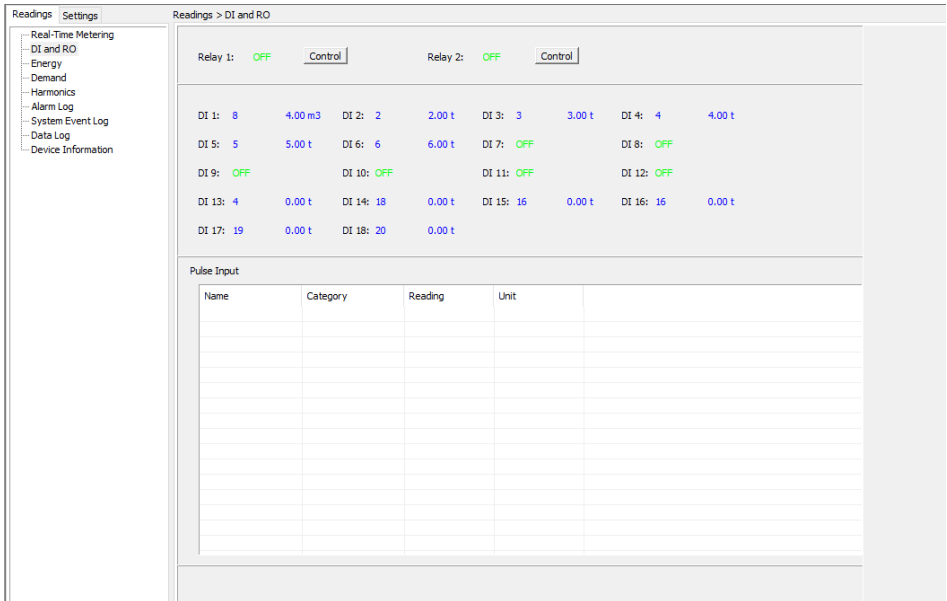

Figure 4-18 Relay Output Readings

4.6.3 Digital Output

The AcuRev 2100 has 6 Digital Outputs channels where the meter will output energy pulses. The DO settings can be configured from the **General Settings** page on Acuviv.

Users can configure each channel to output pulses based on energy, either the total energy or individual circuit energy consumption.

Energy pulse settings include Pulse Constant and Pulse Width. The pulse Constant's range is 1-60000, and the Pulse Width range is 20-100 ms. In practical applications, Pulse Constant and Pulse Width should be set according to the system's real power, otherwise, it will influence the system's energy accuracy.

$$\text{Pulse Period} = 3600000 / (\text{Real Power} \times \text{Pulse Constant})$$

Pulse Period > Pulse Width

The following equation must be fulfilled in order to ensure the energy accuracy, the unit of Real Power is kW, Pulse Width is in ms.

$$3600000 / (\text{Real Power} \times \text{Pulse Constant}) > \text{Pulse Width}$$

For example, if the Real Power is 35.2 kW, Pulse Width = 3600000 / (35.2 x Pulse Constant), it must meet 3600000 / (35.2 x Pulse Constant) > Pulse Width.

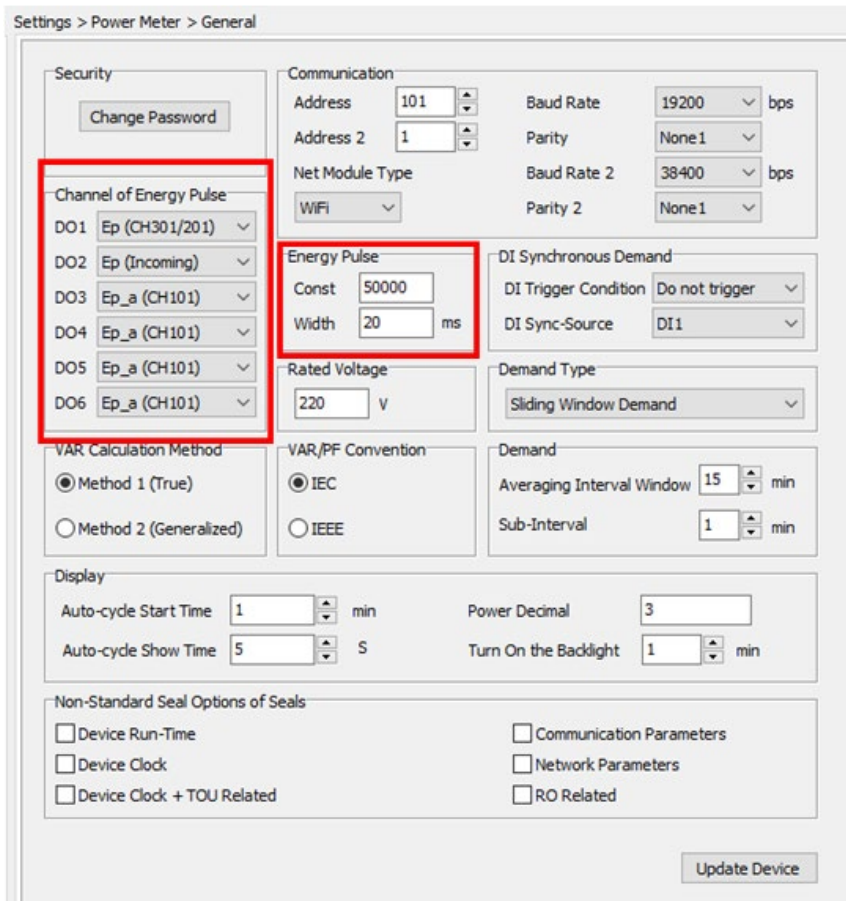

Figure 4-19 Digital Output Settings

4.7 Alarm

The AcuRev 2100 supports over/under alarms where the meter can have up to 10 alarms configured. Users can configure this by clicking on **Alarm** under the **Settings** tab on Acuvue.

Users can alarm for either the individual circuit channels or alarm for the meter total (inline), this can be configured in the category drop down menu. The following category options are available:

- Real-Time Metering (Incoming) - active power, reactive power, apparent power, frequency, voltage, current, power factor of the incoming line
- Real-Time Metering (User) - active power, reactive power, apparent power, current, power factor of the individual circuits
- Demand (Incoming) - active power, reactive power, apparent power, current demand and demand prediction
- Demand (User) - active power, reactive power, apparent power, current demand and demand prediction of the individual circuits

After the category is selected, users can then select the desired alarming parameter in the parameter drop down menu. Once configured select the setting for the alarm, this can be over (>), under(<), or equal.

The setpoint value will be a percentage of the rated value and not the actual measurement value. The current rating and voltage rating refer to the rated voltage and current value of the load, which are used to generate the alarm target value. For example, suppose the voltage rating is 220V, the CT rating is 20A, and the user wants to alarm when the active power is over 3kW. Since the rated power is 4.4kW and 3kW is 68% of 4.4kW, the alarm target value is set to 68.

Users have the option to set a delay for the alarms, where the alarm will trigger after the delay time has passed. The default is 0 which means there is no delay and the alarm will trigger as soon as it occurs. The delay time range is from 0-30000 ms.

If the relay mode is configured for Alarm mode, users can use the over/under alarms to trigger the relay output. Users can select RO1 or RO2 from the output drop down menu.

Settings > Power Meter > Alarm

Enable Alarm

Limit ID	Enable	Alarm Channel	Setting	Setpoint	Delay (ms)	Output
#1	<input checked="" type="checkbox"/>	Real-Time Metering(Incoming) > Frequency	> >	40	0	RO1
#2	<input checked="" type="checkbox"/>	Real-Time Metering(User) > Watt A (CH102)	> >	10 %	0	None
#3	<input checked="" type="checkbox"/>	Real-Time Metering(Incoming) > Volts AN	> >	100 %	0	None
#4	<input checked="" type="checkbox"/>	Real-Time Metering(Incoming) > I A	< <	50 %	0	None
#5	<input checked="" type="checkbox"/>	Demand(Incoming) > Watt A	> >	25 %	0	RO2
#6	<input checked="" type="checkbox"/>	Real-Time Metering(User) > Watt Total (CH305/205)	> >	1 %	0	None
#7	<input type="checkbox"/>	Real-Time Metering(Incoming) > Watt Total	> >	0 %	0	None
#8	<input type="checkbox"/>	Real-Time Metering(Incoming) > Watt Total	> >	0 %	0	None
#9	<input type="checkbox"/>	Real-Time Metering(Incoming) > Watt Total	> >	0 %	0	None
#10	<input type="checkbox"/>	Real-Time Metering(Incoming) > Watt Total	> >	0 %	0	None

Update Device

Figure 4-20 Alarm Settings

The alarms can be read in the **Alarm Log** under the **Readings** tab on Acuvue. The alarm record shows the time of the alarm, the alarm parameter, the limit value exceeded or restored value, the alarm state and the alarm rule. Up to 20 alarms can be recorded, and will override from the oldest alarm entry (first in, first out).

The software displays the newest alarm record number and allows users to reset the alarm log using the **Clear Alarm** button.

Readings > Alarm Log

No.	Time Stamp	ms	Alarm Channel	Value	Status	Limit ID
1	2020-09-08 11:41:21	517	R1> Frequency (Incomi...	40	Reset	1
2	2020-09-08 11:41:21	524	R1> Frequency (Incomi...	60	Alarm	1
3	2020-09-08 11:41:21	834	R1> Frequency (Incomi...	39	Reset	1
4	2020-09-08 11:41:21	899	R1> Frequency (Incomi...	60	Alarm	1
5	2020-09-08 11:41:23	193	R1> Frequency (Incomi...	39	Reset	1
6	2020-09-08 11:41:23	244	R1> Frequency (Incomi...	60	Alarm	1
7	2020-09-08 11:41:49	8	R1> Frequency (Incomi...	38	Reset	1
8	2020-09-08 11:41:49	61	R1> Frequency (Incomi...	53	Alarm	1
9	2020-06-25 12:23:01	57	R1> Frequency (Incomi...	0	Reset	1
10	2020-06-25 12:23:01	64	R1> Volts AN (Incoming)	0 %	Reset	3
11	2020-09-08 11:39:49	774	R1> Volts AN (Incoming)	4 %	Alarm	3
12	2020-09-08 11:39:49	788	R1> Frequency (Incomi...	60	Alarm	1
13	2020-09-08 11:40:29	62	R1> Frequency (Incomi...	18	Reset	1
14	2020-09-08 11:40:29	130	R1> Frequency (Incomi...	62	Alarm	1
15	2020-09-08 11:40:29	316	R1> Frequency (Incomi...	0	Reset	1
16	2020-09-08 11:40:29	371	R1> Volts AN (Incoming)	0 %	Reset	3
17	2020-09-08 11:40:36	533	R1> Volts AN (Incoming)	4 %	Alarm	3
18	2020-09-08 11:40:36	582	R1> Frequency (Incomi...	59	Alarm	1

Newest Alarm Record No. 8

Clear Alarm Save

Figure 4-21 Alarm Log

NOTE: *The limit value displayed by the tool software is not the actual measurement value, but the percentage of the actual measurement value to the rated value.*

4.8 System Event Log

The event log captures and record significant events that occur in the AcuRev 2100 meter. The log records the time and type of system event. The following are the event types that the AcuRev 2100 supports:

1. Reset
2. DI Synchronization Demand
3. Command Synchronization Demand
4. Reset energy
5. Reset Device Run Time
6. Reset Battery Run Time
7. Modify System Parameters
8. Set Initial Energy
9. Modify TOU Settings
10. Modify System Clock
11. Reversed Power Direction
12. Reset DI Pulse Count

Up to 100 records can be displayed, users can choose to display **the latest 20 records** or **all records**. The event log can be reset by using the **Clear Event** button.

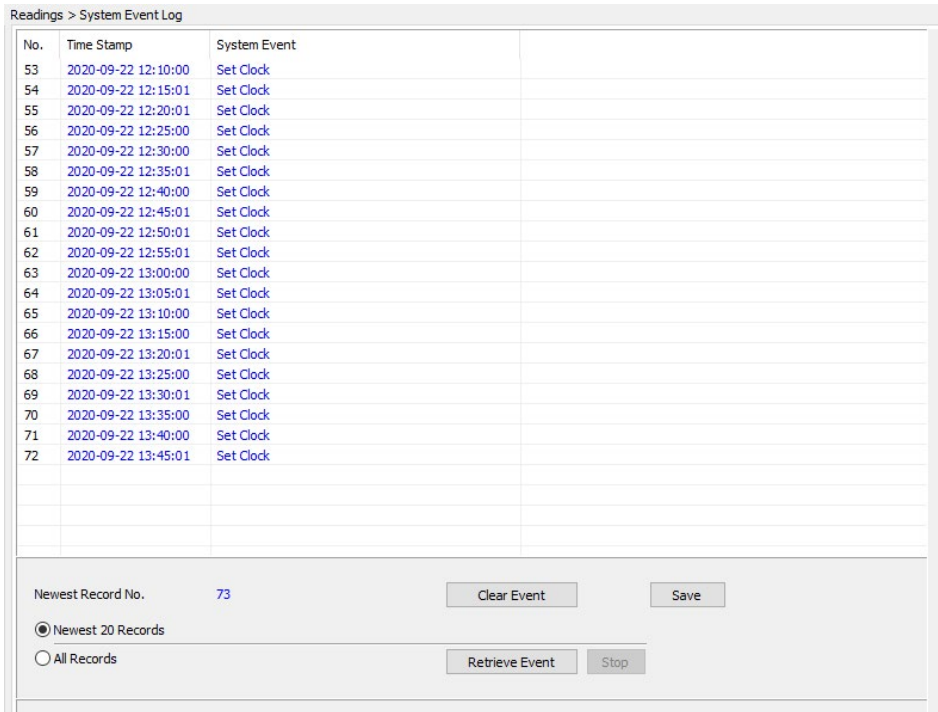

Figure 4-22 Event Log

4.9 Data Log

The AcuRev 2100 includes 8MB of memory that is used for data logging. This allows users to log data and retrieve it from the Acuvue software. In order to configure the meter to data log using the internal memory select **Data Log 1/Data Log 2/Data Log 3** from the **Settings** tab on Acuvue. The AcuRev 2100 has 3 data logs, where each can be configured individually and the three logs can be configured with different parameters.

There are 114 different parameters that can be logged ranging from Real Time Metering, Energy, TOU Energy, Demand, and DI. Users can log either the incoming (inline) or individual circuit parameters. The memory size of the 3 data logs can also be set, but the total number of memory sectors of the 3 records should not be greater than 100.

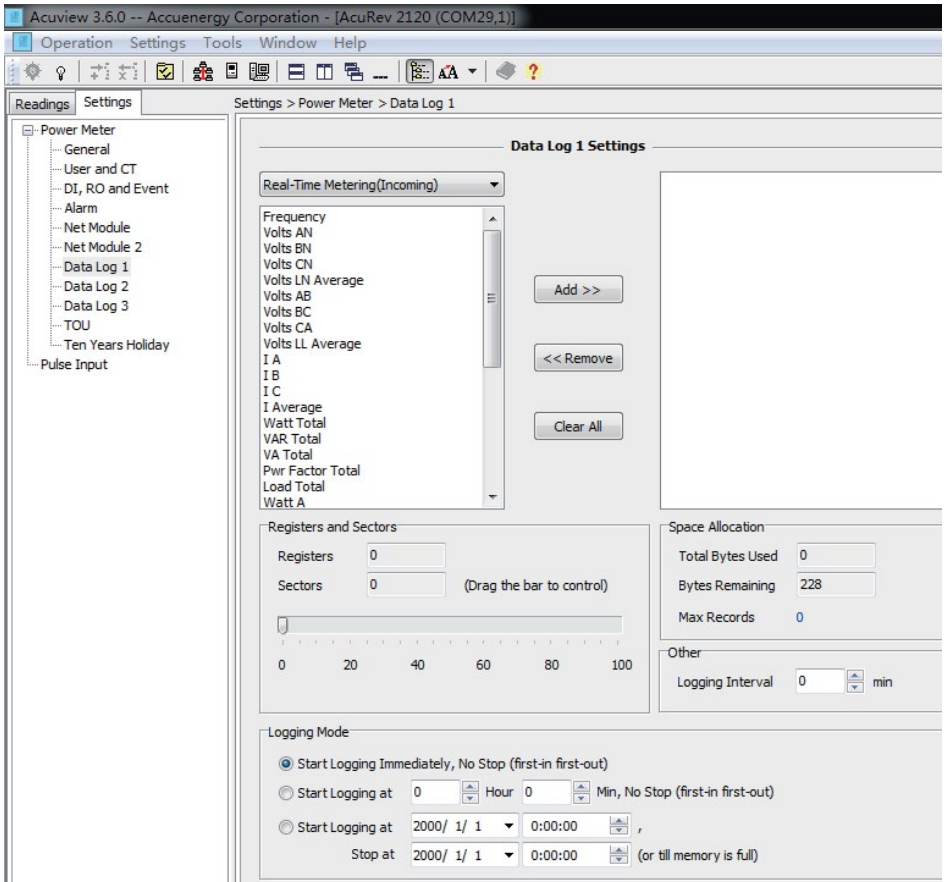

Figure 4-23 Data Log Settings

Different parameters can be set between the 3 data logs according to user requirements. For example, data log 1 can be set as basic measurement parameters (such as power), data log 2 can be set as energy parameters, and data log 3 can be set as demand parameters.

Generally, setting a data log requires setting the following:

- Parameter selection - Choose one of the 8 categories, different wiring methods will be different
- Select parameters

- Select the relevant parameter in the left selection box
- Click the Add button, the selected parameter will be added to the selected box on the right.
- If you want to delete an item, select the parameter you want to delete in the selected box, and then click Delete.
- In the Space Allocation section, users can view the number of registers in the record, the number of bytes that have been used in this record, and the number of remaining bytes. These areas are automatically increased according to the parameters you choose. The total number of bytes that can be used is 228.
- Set the Logging Interval - Users can set the logging interval from 0-1440 minutes. When the interval is selected as 0 the data log function is disabled.
- Set data log sector size - The sector size can be selected from 0-100, but the total sector size of the 3 data logs must not exceed 100.
- Select the Logging Mode:
 - Start Logging Immediately - This mode uses a first in-first out method where once the data log is full the oldest data log entry will be overridden by the newest log entry.
 - Start Time - This mode allows users to configure a start time for the data log. The meter will begin logging at the time specified in this setting. Once the log is full it will start to override from the oldest entry.
 - Time Range - This mode allows users to configure the meter to log data during a specific time period. Users can configure the start and stop time for logging. If the meters memory is full before the stop time the meter will stop data logging.

4.9.1 Reading the Data Log

The data log can be read by selecting **Data Log** under the **Readings** tab. On this page users will be able to the overview of the data which includes the first/last time stamp logged, max records, record size, and the amount of used records.

In the first drop down menu users can select one of the three data logs, and in the second drop down menu users can select the amount of records to read. The following options are available

- Read newest 50 records
- Read 1000 records
- Read 64000 records

- Read 1000 records (Select Time)
- Read 64000 records (Select Time)

Users can also set the record number to start reading the data log at. Click on **Read** to begin reading the data from the data log. There is an option to download the data from Acuviv, users can save the data as a text, csv, or excel format file.

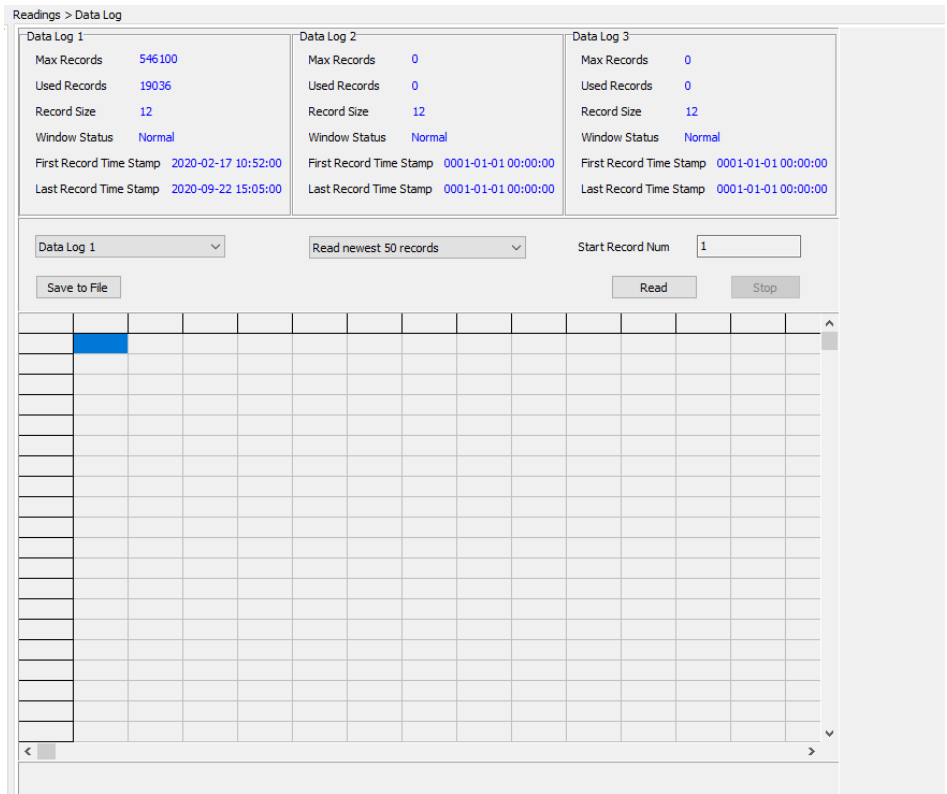

Figure 4-24 Reading the Data Log

4.10 Seal Button (B1) Function

The AcuRev 2100 supports a sealing function that allows user to prevent tampering of the meter settings. When the meter is sealed users cannot change or modify certain settings. There are two types of sealed parameters, standard and non stand parameters.

The sealed parameters include:

- Energy pulse constant
- Energy pulse width
- DO output energy channel selection
- Demand calculation method
- Demand interval window
- Demand sub-interval time
- DI synchronous demand trigger
- All user mapping relations
- Wiring mode
- 1-18 Channel CT Ratio
- DI trigger condition
- Reactive power calculation method
- VAR/PF protocol selection
- Clear energy/demand/DI
- All energy data
- Restore default parameters
- Non-standard seal function selection

The Non Standard sealed parameters include:

- RS485 Communication parameters
- Network Parameters
- Clear meter running time
- TOU parameters
- Relay Output Parameters
- Clock

Users can select the Non Standard seal options from the Acuvue software in the **General Settings**.

Settings > Power Meter > General

Security

Change Password

Channel of Energy Pulse

DO1 Ep (CH301/201) v

DO2 Ep (Incoming) v

DO3 Ep_a (CH101) v

DO4 Ep_a (CH101) v

DO5 Ep_a (CH101) v

DO6 Ep_a (CH101) v

Communication

Address 101

Address 2 1

Net Module Type WiFi

Baud Rate 19200 bps

Parity None1

Baud Rate 2 38400 bps

Parity 2 None1

Energy Pulse

Const 50000

Width 20 ms

DI Synchronous Demand

DI Trigger Condition Do not trigger

DI Sync-Source DI1

Rated Voltage

220 v

Demand Type

Sliding Window Demand

VAR Calculation Method

Method 1 (True)

Method 2 (Generalized)

VAR/PF Convention

IEC

IEEE

Demand

Averaging Interval Window 15 min

Sub-Interval 1 min

Display

Auto-cycle Start Time 1 min

Auto-cycle Show Time 5 S

Power Decimal 3

Turn On the Backlight 1 min

Non-Standard Seal Options of Seals

Device Run-Time

Device Clock

Device Clock + TOU Related

Communication Parameters

Network Parameters

RO Related

Update Device

Figure 4-25 Configuring the Non-Standard Seal Options

4.10.1 How to use the Seal Button (B1)

By default the AcuRev 2100 is sealed, in order to unseal the meter press B1. Users will notice that on the display screen on the settings page certain settings will have a lock-shaped symbol on the top right corner of the display. After pressing B1 the meter will be unsealed for 1 hour where the lock symbol will now show as an unlocked symbol. After the 1 hour has passed the meter will go back to being sealed. During the 1 hour when the meter is unsealed the meter can be sealed again by pressing B1.

NOTE: *When operating the B1 button, you must first ensure that the B1 button is in a state that allows parameter modification.*

4.11 Device Information

Users can view the meters information from the Acuvision by clicking on Device Information under the Readings tab. This provides users with information such as device type, hardware/software version, serial number, device clock, device run time and communications module firmware information.

Device Device Type HS11 (AcuRev 2110) Hardware Version 1.02 Software Version 1.16 Release Date 2023-01-26 Serial Number EHM22080010 Model AcuRev 2110-mA-WEB2-MC Manufacturer Accuenergy(CANADA)Inc. Demand Verified Yes Pulse Verified Yes Seals Status Sealed Allow Programming Yes		Display Module Device Type SC11 Hardware Version 1.02 Software Version 1.16 Release Date 2023-02-03	
		Net Module Device Type WA Hardware Version 1.01 Software Version 0.28 Release Date 2023-02-10	

Device Run-Time **595.94 Hours**

Device Clock **2023-02-17 09:20:27, FRI**

Use PC Time

Figure 4-26 Device Information

Users can reset the meters run time from this page and also configure the meter clock. The device clock can be set manually or according to the computer time, users can click on Set Device Clock for the clock configuration to take affect.

Chapter 5: Communication

5.1 MODBUS Protocol Introduction

5.1.1 Transmission Mode

5.1.2 Protocol

5.1.3 CRC Check

5.2 Modbus Communication Format

5.2.1 Read Relay Output status (Function Code 01)

5.2.2 Read the status of DI (Function Code 02)

5.2.3 Read Data (Function Code 03)

5.2.4 Control Relay Output

5.2.5 Preset/Reset Multi-Register

5.3 AcuRev 2100 Application Details and Parameter Address Table

5.3.1 Type of Data

5.3.2 Correspondence Between Communication Value and Actual Value

5.3.3 Address Table

Chapter 5: Communication

AcuRev 2100 supports the mainstream open communication protocol Modbus.

The standard configuration is Modbus-RTU protocol, this manual only lists the address table under this protocol.

5.1 MODBUS Protocol Introduction

AcuRev 2100 uses the MODBUS-RTU communication protocol. The MODBUS protocol defines the check code, data sequence, etc., which are necessary for specific data exchange.

5.1.1 Transmission Mode

The transmission mode is a series of independent data structures within a data frame and limited rules for data transmission. The transmission mode compatible with the MODBUS-RTU protocol mode is defined below.

Coding System	8-bit
Start bit	1-bit
Stop bit	1-bit
Data bits	8-bit
Error checking	CRC (Cyclic Redundancy Check)
Parity	No parity/odd parity/even parity

5.1.2 Protocol

When a data frame arrives at the terminal device, it enters the addressed device through a simple "port", the device removes the "envelope" (data header) of the data frame, reads the data, and if there is no error, it executes the data transfer. The requested task, then, adds the data it generates to the obtained "envelope" and returns the data frame to the sender. The returned response data contains the following content: the terminal slave address (Address), the executed command (Function), the requested data (Data) generated by executing the command, and a check code (Check). There will be no successful response if any error occurs.

1. Frame Format

Table 5-1 Data Frame Format

Address	Function	Data	Check
08-bit	8-bit	N * 8-bit	16-bit

2. Address Field

The address field is at the start of the frame. It is composed of 1 byte (8 bits), its decimal value range is 0-247.

A master addresses a slave by placing the slave address in the address field of the message. When the slave sends its response, it places its own address in this address field of the response to let the master know which slave is responding.

3. Function Field

When a message is sent from a master to a slave device the function code field tells the slave what kind of action to perform.

Table 5-2 Function Code

Code	Meaning	Action
01	Read DO status	Obtain Digital (Relay) Output current status (ON/OFF)
02	Read DI status	Obtain Digital Input current status (ON/OFF)
03	Read Data	Obtain current binary value from one or more registers
05	Control DO	Control Digital (Relay) Output (ON/OFF)
16	Preset multiple registers	Place specific value into a series of consecutive multiple-registers

4. Data Field

The Data field contains the data that terminals need to complete the request and the data that terminals respond to the request. This data may be a numerical value, address or setting. For example, Function Code tells the terminal to read one register, Data Field needs to specify

reading from which register and how many registers to read.

5. Error Check Field

The field allows the error check by master and slave devices. Due to electrical noise and other interferences, a group of data may be changed while transmitting from one location to the other. Error Check ensures master or slave devices do not respond to the distorted data during the transmission, which enhances system security and efficiency. Error Check uses 16-bit Cyclic Redundancy Check (CRC 16).

5.1.3 CRC Check

The cyclic redundancy check (CRC) field occupies two bytes and contains a 16-bit binary value. The CRC value is calculated by the transmitting device and then appended to the data frame. The receiving device recalculates the CRC value when receiving the data, and then compares it with the value in the received CRC field. If the two values are not equal, it will happen. error.

During the CRC operation, first preset a 16-bit register to all 1s, and then continuously calculate the 8 bits in each byte in the data frame with the current value of the register, only 8 data per byte Bit participates in generating CRC, start bit, stop bit and possible parity bit does not affect CRC. When generating the CRC, the 8 bits of each byte is XORed with the contents of the register, and then the result is shifted to the low bit, the high bit is supplemented with "0", and the least significant bit (LSB) is shifted out and checked. If it is 1, This register is XORed with a preset fixed value (0A001H). If the lowest bit is 0, no processing is done.

The above processing is repeated until 8 shift operations are performed. After the last bit (the 8th bit) is shifted, the next 8-bit byte is XORed with the current value of the register, and the other 8 above is also performed. When all the bytes in the data frame are processed, the final value generated is the CRC value.

The process of generating a CRC is:

1. Preset a 16-bit register as 0FFFFH (all 1s), which is called the CRC register.
2. Perform exclusive OR operation on the 8 bits of the first byte in the data frame and the low byte in the CRC register, and store the result back to the CRC register.
3. Shift the CRC register one bit to the right, fill the highest bit with 0, and move the lowest bit out and check.

4. If the lowest bit is 0: repeat the third step (the next shift); if the lowest bit is 1: connect the CRC register to a preset. The fixed value (0A001H) is XORed.
5. Repeat the third and fourth steps until 8 shifts. A complete eight bits are processed in this way.
6. Repeat steps 2 to 5 to process the next eight bits until all byte processing ends.
7. Swap the high and low bytes of the CRC register, the result is the CRC value.

5.2 Modbus Communication Format

The examples in this section will use the format shown in Table 5-3 as much as possible (the numbers are in hexadecimal).

Table 5-3 Protocol Example

Address	Function	Data Start Reg Hi	Data Start Reg Lo	Data #of Regs Hi	Data #of Regs Lo	CRC16 Hi	CRC16 Lo
06H	03H	00H	00H	00H	21H	84H	65H

Addr: Slave device address

Fun: Function Code

Data start reg hi: Start register address, high byte

Data start reg lo: Start register address, low byte

Data #of reg hi: Number of registers, high byte

Data #of reg lo: Number of registers, low byte

CRC16 Hi: CRC high byte

CRC16 Lo: CRC low byte

5.2.1 Read Relay Output status (Function Code 01)

Query

The master device sends a query frame to the slave device. Function Code 01 allows users to acquire the relay output status (1=ON, 0=OFF) of the slave device with the specified address. On top of the slave device address and function code, the query frame must contain the relay register starting address and the number of registers to be read.

Table 5-4 depicts reading Relay 1 and Relay 2 status of the slave device with the address of 17.

Table 5-4 Query Frame of Reading Relay Output Status

Address	Function	Relay Start Reg Hi	Relay Start Reg Lo	Relay #of Regs Hi	Relay #of Regs Lo	CRC16 Hi	CRC16 Lo
11H	01H	00H	00H	00H	02H	BFH	5BH

Response

The slave device answers the master device's query. The response frame contains a slave device address, function code, data quantity and CRC check. Each relay utilizes one bit (1 = ON , 0 = OFF). Table 5-5 depicts the response frame.

Table 5-5 Response frame of reading Relay Output status

Address	Function	Byte Count	Data	CRC16 Hi	CRC16 Lo
11H	01H	01H	02H	D4H	89H

Data Bytes

7	6	5	4	3	2	1	0
0	0	0	0	0	0	1	0
MSB							LSB

(Relay 1 = OFF, Relay 2=ON)

5.2.2 Read the status of DI (Function Code 02)

Query

On top of the slave device address and function code, the query frame must contain the digital input register starting address and the number of registers to be read. DI register address starts from 0000H (DI1=0000H, DI2=0001H, DI3=0002H, DI4=0003H).

Table 5-6 depicts reading DI1 to DI4 status of the slave device with the address of 17.

Table 5-6 Query frame of reading DI status

Address	Function	DI Start Addr Hi	DI Start Addr Lo	DI Num Hi	DI Num Lo	CRC16 Hi	CRC16 Lo
11H	02H	00H	00H	00H	04H	7BH	59H

Response

The slave device answers the master device's query. The response frame contains a slave device address, function code, data quantity and CRC check. Each DI utilizes one bit (1 = ON , 0 = OFF).Table 5-7 depicts the response frame.

Table 5-7 Response Frame of Reading DI1 to DI4 Status

Address	Function	Byte Count	Data	CRC16 Hi	CRC16 Lo
11H	02H	01H	03H	E5H	49H

Data Bytes

0	0	0	0	DI4	DI3	DI2	DI1
0	0	0	0	0	0	1	0
MSB							LSB

5.2.3 Read Data (Function Code 03)

Query

This function allows users to obtain the data and system parameters collected and recorded by the device.

The example in Table 5-8 is reading three basic data collected from the address 17 slave machine into line A real-time energy, line B real-time energy, and line C real-time energy (these parameters are dword data types, each parameter occupies two addresses, each address two bytes), the address of incoming line A real-time energy in AcuRev 2100 is 4500H, 4501H;

incoming line B real-time energy address is 4502H, 4503H; incoming line C real-time energy address is 4504H,4505H.

Table 5-8 Query of Inline A Real-time Energy, Inline B Real-time Energy, Inline C Real-time Energy

Address	Function	Data Start Addr Hi	Data Start Addr Lo	Data #of Regs Hi	Data #of Regs Lo	CRC16 Hi	CRC16 Lo
11H	03H	45H	00H	00H	06H	D2H	54H

Response

The response frame contains slave device address, function code, data quantity and CRC check.

Table 5-9 depicts Inline A real-time energy=0000000BH (1.1kWh), Inline B real-time energy= 0000000CH (1.2kWh), Inline C real-time energy=0000000D (1.3kWh).

Table 5-9 Response of Inline A Real-time Energy, Inline B Real-time Energy, Inline C Real-time Energy

Address	Function	Byte Count	Data 1 Hi	Data 1 Lo	Data 2 Hi	Data 2 Lo	Data 3 Hi	Data 3 Lo	Data 4 Hi	Data 4 Lo
11H	03H	0CH	00H	00H	00H	0BH	00H	00H	00H	0CH

Data 5 Hi	Data 5 Lo	Data 6 Hi	Data 6 Lo	CRC16 Hi	CRC16 Lo
11H	02H	01H	03H	E5H	49H

5.2.4 Control Relay Output (Function Code 05)

Query

This query frame forces the relay status to ON or OFF. Data FF00H sets the relay as ON, and data 0000H sets the relay as OFF. The relay will not be influenced by any other data input.

The following is to query slave device 17 to set relay status is ON.

Table 5-10 Control Relay Status Query Frame

Address	Function	DO Addr Hi	DO Addr Lo	Value Hi	Value Lo	CRC16 Hi	CRC16 Lo
11H	05H	00H	00H	FFH	00H	8EH	AAH

Response

The correct response to this request is to send back the received data after the relay status is changed.

Table 5-11 Control Relay Status Response Frame

Address	Function	DO Addr Hi	DO Addr Lo	Value Hi	Value Lo	CRC16 Hi	CRC16 Lo
11H	05H	00H	00H	FFH	00H	8EH	AAH

5.2.5 Preset/Reset Multi-Register (Function Code 16)

Query

Function Code 16(10H Hex) allows the user to modify the contents of multiple registers.

The example below is a request to preset the device address of 17's channel #1's real-time energy as 12345.6 kWh. AcuRev 2100 energy is raw data multiplied by 0.1 kWh, therefore, the value written into the register should be 123456, hex format is 01E240H. Channel 1's real-time energy address is 4600H and 4601H, 32 bit, a total of 4 Bytes.

Table 5-12 Preset Tenant #1's Real-time Energy

Address	Function	Data Start Reg Hi	Data Start Reg Lo	Data #of Regs Hi	Data #of Regs Lo	Byte Count
11H	10H	46H	00H	00H	02H	04H

Value Hi	Value Lo	Value Hi	Value Lo	CRC16 Hi	CRC16 Lo
00H	02H	E2H	40H	BEH	B6H

Response

The correct response is to send back address, function code, data starting address, data bytes, CRC check after the value is changed.

Table 5-13 Preset Multi-register Response Frame

Address	Function	Data Start Reg Hi	Data Start Reg Lo	Data #of Regs Hi	Data #of Regs Lo	CRC16 Hi	CRC16 Lo
11H	10H	46H	00H	00H	02H	56H	10H

5.3 AcuRev 2100 Application Details and Parameter Address Table

There are several conventions of AcuRev 2100.

5.3.1 Type of Data

"Bit" refers to binary bits.

"Word" is a 16-bit unsigned integer, occupying a data address. Two bytes. The value range is 0~65535.

"Int" is a 16-bit signed integer, occupying a data address. Two bytes. The value range is -32768~32767.

"Dword" is a 32-bit unsigned integer, occupying two data addresses. The high word comes first, and the low word comes after. A total of 4 bytes. Value range 0~4294967295; Rx = high word X65536 + low word.

"Float" is a single-precision floating-point number, occupying two data addresses. A total of 4 bytes. The value range is 0.0~3.402823E +38.

5.3.2 Correspondence Between Communication Value and Actual Value

The communication value of the instrument is not necessarily equal to the actual value. There is a certain conversion relationship between them. This is very important. The production of the upper-level software must make it clear which conversion relationship is used for the collected parameters, otherwise, it will lead to wrong results.

Table 5-14 Correspondence Between Communication Value and Actual Value

Applicable Parameters	Correspondence	Unit
System parameter	The actual value is equal to the communication value	No unit
Meter and battery runtime	$T=R_x/100$	Hour
Real clock, all time labels	The actual value is equal to the communication value	Time unit
Energy	$E=R_x/100$	kWh

Power	R	0~65535 (0.01 accuracy)
Demand	The actual value is equal to the communication value	kW
Frequency	The actual value is equal to the communication value	Hz
Power factor	The actual value is equal to the communication value	No unit
Voltage	The actual value is equal to the communication value	Volt
Current	The actual value is equal to the communication value	Amp
Harmonic parameters	The actual value is equal to the communication value	No unit
Pulse count value	Value=Rx/100	See specific settings

5.3.3 Address Table

System Parameter Settings

Address (H)	Address (D)	Parameters	Range	Default	Data Type	Access Property
800H	2048	RS485 Device Address	1-247	1	word	R/W
801H	2049	RS485 Modbus Communication Parity Bit Setting	0: Even 1:Odd 2:None2 3:None1	3	word	R/W
802H	2050	Channel 2 Modbus Communication Parity	0: Even 1:Odd 2:None2 3:None1	3	word	R/W
803H	2051	RS485 Modbus Communication Baud Rate	1200-115200 When setting 115200, write (11520)	19200	word	R/W

Address (H)	Address (D)	Parameters	Range	Default	Data Type	Access Property
804H	2052	Channel 2 Modbus Communication Baud Rate	1200-115200 When setting 115200, write (11520)	38400	word	R/W
805H	2053	Password	0000-9999	0000	word	R/W
806H	2054	Energy Pulse Constant Low Byte	1-65535	50000	word	R/W
807H	2055	Energy Pulse Width	20-100ms	80	word	R/W
808H	2056	Modbus TCP Device Address	1-247	1	word	R/W
809H	2057	Energy Pulse Constant - High byte	1-100	0	word	R/W
80AH	2058	Demand Calculation Method	0: Sliding Window 1: Rolling Window 2: Fixed Window 3: Thermal	0	word	R/W
80BH	2059	Demand Interval	1-30 mins	15	word	R/W
80CH	2060	Demand Sub-Interval	1-30mins	1	word	R/W
80DH	2061	CT Type	80: 80mA 100: 100mA	80	word	R/W
80EH	2062	RS485 Protocol Selection	0: Modbus 2: BACnet MS/TP	0	word	R/W
80FH	2063	BACnet MS/TP Device Address	0-127	1	word	R/W

Address (H)	Address (D)	Parameters	Range	Default	Data Type	Access Property
810H	2064	BACnet MS/TP Baud Rate	1200-115200 (When setting 115200, write 11520)	19200	word	R/W
811H	2065	BACnet MS/TP Max Info Frames	1-255	10	word	R/W
812H	2066	BACnet MS/TP BACnet ID - High byte	0-63	0	word	R/W
813H	2067	BACnet MS/TP BACnet ID - Low byte	1-65535	1	word	R/W
814H - 827	2068 - 2087	Reserved			word	R/W
828H	2088	Relay Output Mode	bit0~bit1 corresponds to RO1~RO2 0: Relay Control 1: Alarm	0	word	R/W
829H	2089	RO Relay Control Output Mode	bit0~bit1 to RO1~RO2 0: Latch 1: Momentary	0	word	R/W
82AH	2090	RO Relay Control Momentary Time	50-3000ms	80	word	R/W
82BH	2091	Alarm Enable	0:Disable 1:Enable	0	word	R/W

Address (H)	Address (D)	Parameters	Range	Default	Data Type	Access Property
82CH	2092	Alarm Channel Enable 1-10	Bit0-bit9 corresponds to 1-10 1: Enable 0: Disable	0	word	R/W
82DH	2093	System Alarm Event	Bit0-15 corresponds to 16 Event 1: Enable 0: Disable	0	word	R/W
82EH	2094	Relay Output selection for first 8 System Alarm Events	2 bytes, every 2 bits corresponds to an event 00 Relay1 01 Relay2	0	word	R/W
82FH	2095	Relay Output selection for last 8 System Alarm Events	22 bytes, every 2 bits corresponds to an event 00: Relay1 01: Relay2	0	word	R/W
830H	2096	Relay Output Alarm time delay (the over-limit alarm does not have this function)	1-60000s	60	word	R/W
831H	2097	Backlight Time	0-60mins	1	word	R/W
832H	2098	Automatic Display if no key is pressed	Mins: 1-60	1	word	R/W
833H	2099	Screen Display Time per Screen	Seconds: 5-100	5	word	R/W
834H	2100	Display power (demand) decimal places	3-4 decimal	3	word	R/W

Address (H)	Address (D)	Parameters	Range	Default	Data Type	Access Property
835H	2101	Reactive Power Calculation Method	0: Real 1: Generalized	0	word	R/W
836H	2102	VAR/PF Convention	0: IEC 1: IEEE	0	word	R/W
837H	2103	Clear all data digits to clear all records	Set 1 to clear Bit0: Clear current month and historical electricity Bit1: Clear demand Bit2: Clear SOE record Bit3: Clear the alarm record Bit4: Clear the event record Bit5: Clear the meter runtime Bit6: Clear the battery runtime Bit7: Reserved	0	word	R/W
838H - 839H	2104 - 2105	The DI pulse count value is cleared, each bit represents one DI channel	838 address bit0~bit15 corresponds to DI1~DI16 839 address bit0~bit1 corresponds to DI17~DI18 0: No Clear 1: Clear	0	word	R/W
83AH - 83EH	2106 - 2110	Reserved				
83FH - 841H	2111 - 2113	user01 user name	user name (6 ASCII)	user01	word	R/W

Address (H)	Address (D)	Parameters	Range	Default	Data Type	Access Property
842H	2114	user01 Mapping	High byte: 0: The display module does not display the user 1: The display module displays the user Low byte 0: Disable 1-18: corresponding physical channel 19-24: Corresponding to three-phase users of 1-6 channels 25-27: Corresponding to two-phase users of 7-9 channels (in Network wiring only)	0x0101	word	R/W
843H - 845H	2115 - 2117	user02 user name	user name (6 ASCII)	user02	word	R/W
846H	2118	user02 Mapping	High byte: 0: The display module does not display the user 1: The display module displays the user Low byte 0: Disable 1-18: corresponding physical channel 19-24: Corresponding to three-phase users of 1-6 channels 25-27: Corresponding to two-phase users of 7-9 channels (in Network wiring only)	0x0102	word	R/W

Address (H)	Address (D)	Parameters	Range	Default	Data Type	Access Property
847H - 849H	2119 - 2121	user03 user name	user name (6 ASCII)	user03	word	R/W
84AH	2122	user03 Mapping	<p>High byte:</p> <p>0: The display module does not display the user 1: The display module displays the user</p> <p>Low byte</p> <p>0: Disable</p> <p>1-18: corresponding physical channel 19-24: Corresponding to three-phase users of 1-6 channels 25-27: Corresponding to two-phase users of 7-9 channels (in Network wiring only)</p>	0x0103	word	R/W
84BH - 84DH	2123 - 2125	user04 user name	user name (6 ASCII)	user04	word	R/W

Address (H)	Address (D)	Parameters	Range	Default	Data Type	Access Property
84EH	2126	tuser04 Mapping	<p>High byte:</p> <p>0: The display module does not display the user 1: The display module displays the user</p> <p>Low byte</p> <p>0: Disable 1-18: corresponding physical channel 19-24: Corresponding to three-phase users of 1-6 channels 25-27: Corresponding to two-phase users of 7-9 channels (in Network wiring only)</p>	0x0104	word	R/W
84FH - 851H	2127 - 2129	user05 user name	user name (6 ASCII)	user05	word	R/W
852H	2130	user01 Mapping relations	<p>High byte:</p> <p>0: The display module does not display the user 1: The display module displays the user</p> <p>Low byte</p> <p>0: Disable 1-18: corresponding physical channel 19-24: Corresponding to three-phase users of 1-6 channels 25-27: Corresponding to two-phase users of 7-9 channels (in Network wiring only)</p>	0x0105	Word	R/W

Address (H)	Address (D)	Parameters	Range	Default	Data Type	Access Property
853H - 855H	2131 - 2133	user06 Mapping	user name (6 ASCII)	user06	Word	R/W
856H	2134	user06 Mapping	<p>High byte:</p> <p>0: The display module does not display the user 1: The display module displays the user</p> <p>Low byte</p> <p>0: Disable</p> <p>1-18: corresponding physical channel 19-24: Corresponding to three-phase users of 1-6 channels 25-27: Corresponding to two-phase users of 7-9 channels (in Network wiring only)</p>	0x0106	Word	R/W
857H - 859H	2135 - 2137	user07 user name	user name (6 ASCII)	user07	Word	R/W

Address (H)	Address (D)	Parameters	Range	Default	Data Type	Access Property
85AH	2138	user07 Mapping	<p>High byte:</p> <p>0: The display module does not display the user 1: The display module displays the user</p> <p>Low byte</p> <p>0: Disable</p> <p>1-18: corresponding physical channel 19-24: Corresponding to three-phase users of 1-6 channels 25-27: Corresponding to two-phase users of 7-9 channels (in Network wiring only)</p>	0x0107	Word	R/W
85BH - 85DH	2139 - 2141	user08 user name	user name (6 ASCII)	user08	Word	R/W
85EH	2142	user08 Mapping	<p>High byte:</p> <p>0: The display module does not display the user 1: The display module displays the use</p> <p>Low byte</p> <p>0: Disable</p> <p>1-18: corresponding physical channel 19-24: Corresponding to three-phase users of 1-6 channels 25-27: Corresponding to two-phase users of 7-9 channels (in Network wiring only)</p>	0x0108	Word	R/W

Address (H)	Address (D)	Parameters	Range	Default	Data Type	Access Property
85FH - 861H	2143 - 2145	user09 user name	user name (6 ASCII)	user09	Word	R/W
862H	2146	user09 Mapping	<p>High byte:</p> <p>0: The display module does not display the user 1: The display module displays the user</p> <p>Low byte</p> <p>0: Disable</p> <p>1-18: corresponding physical channel 19-24: Corresponding to three-phase users of 1-6 channels 25-27: Corresponding to two-phase users of 7-9 channels (in Network wiring only)</p>	0x0109	Word	R/W
863H - 865H	2147 - 2149	user10 user name	user name (6 ASCII)	user10	Word	R/W

Address (H)	Address (D)	Parameters	Range	Default	Data Type	Access Property
866H	2150	user10 Mapping	<p>High byte: 0: The display module does not display the user 1: The display module displays the user</p> <p>Low byte 0: Disable 1-18: corresponding physical channel 19-24: Corresponding to three-phase users of 1-6 channels 25-27: Corresponding to two-phase users of 7-9 channels (in Network wiring only)</p>	0x010a	Word	R/W
867H - 869H	2151 - 2153	user11 user name	user name (6 ASCII)	user11	Word	R/W
86AH	2154	user11 Mapping	<p>High byte: 0: The display module does not display the user 1: The display module displays the user</p> <p>Low byte 0: Disable 1-18: corresponding physical channel 19-24: Corresponding to three-phase users of 1-6 channels 25-27: Corresponding to two-phase users of 7-9 channels (in Network wiring only)</p>	0x010b	Word	R/W

Address (H)	Address (D)	Parameters	Range	Default	Data Type	Access Property
86BH - 86DH	2155 - 2157	user12 user name	user name (6 ASCII)	user12	Word	R/W
86EH	2158	user12 Mapping	<p>High byte:</p> <p>0: The display module does not display the user 1: The display module displays the user</p> <p>Low byte</p> <p>0: Disable</p> <p>1-18: corresponding physical channel 19-24: Corresponding to three-phase users of 1-6 channels 25-27: Corresponding to two-phase users of 7-9 channels (in Network wiring only)</p>	0x010c	Word	R/W
86FH - 871H	2159 - 2161	user13 user name	user name (6 ASCII)	user13	Word	R/W

Address (H)	Address (D)	Parameters	Range	Default	Data Type	Access Property
872H	2162	user13 Mapping	<p>High byte:</p> <p>0: The display module does not display the user 1: The display module displays the user</p> <p>Low byte</p> <p>0: Disable</p> <p>1-18: corresponding physical channel 19-24: Corresponding to three-phase users of 1-6 channels 25-27: Corresponding to two-phase users of 7-9 channels (in Network wiring only)</p>	0x010d	Word	R/W
873H - 875H	2163 - 2165	user14 user name	user name (6 ASCII)	user14	Word	R/W
876H	2166	user14 Mapping	<p>High byte:</p> <p>0: The display module does not display the user 1: The display module displays the user</p> <p>Low byte</p> <p>0: Disable</p> <p>1-18: corresponding physical channel 19-24: Corresponding to three-phase users of 1-6 channels 25-27: Corresponding to two-phase users of 7-9 channels (in Network wiring only)</p>	0x010e	Word	R/W

Address (H)	Address (D)	Parameters	Range	Default	Data Type	Access Property
877H - 879H	2167 - 2169	user15 user name	user name (6 ASCII)	0x010f	Word	R/W
87AH	2170	user15 Mapping	<p>High byte:</p> <p>0: The display module does not display the user 1: The display module displays the user</p> <p>Low byte</p> <p>0: Disable</p> <p>1-18: corresponding physical channel 19-24: Corresponding to three-phase users of 1-6 channels 25-27: Corresponding to two-phase users of 7-9 channels (in Network wiring only)</p>	0x010f	Word	R/W
87BH - 87DH	2171 - 2173	user16 user name	user name (6 ASCII)	user16	Word	R/W

Address (H)	Address (D)	Parameters	Range	Default	Data Type	Access Property
87EH	2174	user16 Mapping	<p>High byte: 0: The display module does not display the user 1: The display module displays the user</p> <p>Low byte 0: Disable 1-18: corresponding physical channel 19-24: Corresponding to three-phase users of 1-6 channels 25-27: Corresponding to two-phase users of 7-9 channels (in Network wiring only)</p>	0x0110	Word	R/W
87FH - 881H	2175 - 2177	user17 user name	user name (6 ASCII)	user17	Word	R/W
882H	2178	user17 Mapping	<p>High byte: 0: The display module does not display the user 1: The display module displays the user</p> <p>Low byte 0: Disable 1-18: corresponding physical channel 19-24: Corresponding to three-phase users of 1-6 channels 25-27: Corresponding to two-phase users of 7-9 channels (in Network wiring only)</p>	0x0111	Word	R/W

Address (H)	Address (D)	Parameters	Range	Default	Data Type	Access Property
883H - 885H	2179 - 2181	user18 user name	user name (6 ASCII)	user18	Word	R/W
886H	2182	user18 Mapping	<p>High byte:</p> <p>0: The display module does not display the user 1: The display module displays the user</p> <p>Low byte</p> <p>0: Disable</p> <p>1-18: corresponding physical channel 19-24: Corresponding to three-phase users of 1-6 channels 25-27: Corresponding to two-phase users of 7-9 channels (in Network wiring only)</p>	0x0112	Word	R/W
887H	2183	Rated voltage setting (Only relative to Alarm Setting)	Default 220V	220	Word	R/W
888H	2184	Wiring Mode	<p>0: 1LN 1: 3LN (Three-phase four-wire) 2: 2LN (Single-phase three-wire) 3: 2LL 4: Network</p>	0	Word	R/W
889H	2185	Channel 1 CT Rating	5-2000	200	Word	R/W

Address (H)	Address (D)	Parameters	Range	Default	Data Type	Access Property
88AH	2186	Channel 2 CT Rating	5-2000	200	Word	R/W
88BH	2187	Channel 3 CT Rating	5-2000	200	Word	R/W
88CH	2188	Channel 4 CT Rating	5-2000	200	Word	R/W
88DH	2189	Channel 5 CT Rating	5-2000	200	Word	R/W
88EH	2190	Channel 6 CT Rating	5-2000	200	Word	R/W
88FH	2191	Channel 7 CT Rating	5-2000	200	Word	R/W
890H	2192	Channel 8 CT Rating	5-2000	200	Word	R/W
891H	2193	Channel 9 CT Rating	5-2000	200	Word	R/W
892H	2194	Channel 10 CT Rating	5-2000	200	Word	R/W
893H	2195	Channel 11 CT Rating	5-2000	200	Word	R/W
894H	2196	Channel 12 CT Rating	5-2000	200	Word	R/W
895H	2197	Channel 13 CT Rating	5-2000	200	Word	R/W
896H	2198	Channel 14 CT Rating	5-2000	200	Word	R/W
897H	2199	Channel 15 CT Rating	5-2000	200	Word	R/W

Address (H)	Address (D)	Parameters	Range	Default	Data Type	Access Property
898H	2200	Channel 16 CT Rating	5-2000	200	Word	R/W
899H	2201	Channel 17 CT Rating	5-2000	200	Word	R/W
89AH	2202	Channel 18 CT Rating	5-2000	200	Word	R/W
8ADH	2221	Reset to Default (User name & mapping, wiring mode and CT type)	0: None 0xAA: Factory reset	0	Word	R/W
8AEH	2222	Enable Ten Year Settings Download	1: Enable	0	Word	R/W
8AFH	2223	Non-Standard Seal Options	Bit0: Communication Parameters Bit1: Network Parameters Bit2: Device Run-Time Bit3: Reserved Bit4: Device Clock + TOU Related Bit5: RO Related Bit6: Device Clock 1: Enable 0: Disable	0	Word	R/W
8B0H	2224	Seal Status	0: Unsealed 0x0A: Sealed	0	Word	R/W

Address (H)	Address (D)	Parameters	Range	Default	Data Type	Access Property
8B1H	2225	DO1 Channel Setting	0: No output 1 to 18: Input channel 1 to 18 19 to 24: User channel 1 to 6 25: Incoming - System 26 to 28: Incoming - Phase A to C 29: Demand Indication 30: Second Indication 31 to 33: User channel 7 to 9 (for Network wiring only)	0	Word	R/W
8B2H	2226	DO2 Channel Setting	Same as above	0	Word	R/W
8B3H	2227	DO6 Channel Setting	Same as above	0	Word	R/W
8B4H	2228	DO4 Channel Setting	Same as above	0	Word	R/W
8B5H	2229	DO5 Channel Setting	Same as above	0	Word	R/W
8B6H	2230	DO6 Channel Setting	Same as above	0	Word	R/W
8B7H	2231	DI Synchronous Demand Trigger Source	1 to 18: DI 1 to 18	1	Word	R/W

Address (H)	Address (D)	Parameters	Range	Default	Data Type	Access Property
8B8H	2232	DI Trigger Condition	0: Do not trigger 1: Rising 2: Falling 3: Changing trigger	0	Word	R/W
8B9H - 8BAH	2233 - 2234	DI Type	8B9H: Bit0 to Bit16 (DI1 to DI6) 8BAH: Bit0 to Bit1 (DI17 to DI18) 0: State 1: Counter	1 in valid bits	Word	R/W
8BBH - 8CCH	2235 - 2252	DI1 to DI18 Counter Pulse Constant	1 to 65535	1	Word	R/W
8CDH - 8DEH	2253 - 2270	DI1 to DI18 Counter Ratio	1 to 65535 (1.00 to 655.35)	1	Word	R/W
8DFH - 8F0H	2271 - 2288	DI1 to DI18 Counter Unit	1: t 2: m3 3: kwh 4: ¥ 5: \$	1	Word	R/W
8F1H	2289	Programming Button Status	0: Disabled 0x0A: Enabled	0	Word	R/W

Clock Settings

Address (H)	Address (D)	Parameters	Access Property	Range	Data Type
1050H - 1051H	4176 - 4177	Meter running time	R	YYYY/ MM/DD HH:MM:SS	dword

Clock

Address (H)	Address (D)	Parameters	Range	Data Type	Access Property
1054H	4180	Clock: Year	0-99	word	R/W
1055H	4181	Clock: month	1-12	word	R/W
1056H	4182	Clock: Day	1-31	word	R/W
1057H	4183	Clock: hour	0-23	word	R/W
1058H	4184	Clock: minutes	0-59	word	R/W
1059H	4185	Clock: seconds	0-59	word	R/W
105AH	4186	Clock: Week	0-6, 0 means Sunday	word	R/W

Basic Measurement

Note: Function code reading 03

Address (H)	Address (D)	Parameters	Description	Relationship	Property	Data Type	Access Property
2000H - 2001H	8192 - 8193	F	System Frequency	F=R _x	Hz	Float	R
2002H - 2003H	8194 - 8195	Phase 1 Voltage	Phase A Line-Neutral Voltage	U1=R _x	V	Float	R
2004H - 2005H	8196 - 8197	Phase 2 Voltage	Phase B Line-Neutral Voltage	U2=R _x	V	Float	R

Address (H)	Address (D)	Parameters	Description	Relationship	Property	Data Type	Access Property
2006H - 2007H	8198 - 8199	Phase 3 Voltage	Phase C Line- Neutral	U3=Rx	V	Float	R
2008H - 2009H	8200 - 8201	Average Phase Voltage	Average Line- Neutral Voltage	Uavg=Rx	V	Float	R
200AH - 200BH	8202 - 8203	Line Voltage 1-2	Line-Line AB Voltage	U12=Rx	V	Float	R
200CH - 200DH	8204 - 8205	Line Voltage 2-3	Line-Line BC Voltage	U23=Rx	V	Float	R
200EH - 200FH	8206 - 8207	Line Voltage 3-1	Line-Line CA Voltage	U31=Rx	V	Float	R
2010H - 2011H	8208 - 8209	Average Line Voltage	Average Line-Line Voltage	Uavg=Rx	V	Float	R
2012H - 2013H	8210 - 8211	Phase A inline Current	Sum of the Phase A currents for all circuits on the meter	IL1=Rx	A	Float	R
2014H - 2015H	8212 - 8213	Phase B inline Current	Sum of the Phase B currents for all circuits on the meter	IL2=Rx	A	Float	R
2016H - 2017H	8214 - 8215	Phase C inline Current	Sum of the Phase C currents for all circuits on the meter	IL3=Rx	A	Float	R

Address (H)	Address (D)	Parameters	Description	Relationship	Property	Data Type	Access Property
2018H - 2019H	8216 - 8217	Average inline Current	Average of the Phase A, Phase B and Phase C inline currents	ILavg=Rx	A	Float	R
201AH - 201BH	8218 - 8219	Total inline System Power	Sum of Phase A, Phase B, and Phase C inline Real Power	Psum=Rx	kW	Float	R
201CH - 201DH	8220 - 8221	Total inline Reactive Power	Sum of Phase A, Phase B, and Phase C inline Reactive Power	Qsum=Rx	kvar	Float	R
201EH - 201FH	8222 - 8223	Total inline Apparent Power	Sum of Phase A, Phase B, and Phase C inline Apparent Power	Ssum=Rx	kVA	Float	R
2020H - 2021H	8224 - 8225	Total inline Power Factor	Average of Phase A, Phase B, and Phase C inline Power Factor	PF=Rx		Float	R
2022H - 2023H	8226 - 8227	Total inline System Load Nature	1: R 2: L 3: C	LC=Rx		Float	R
2024H - 2025H	8228 - 8239	Phase A inline Real Power	Sum of Phase A real power for all circuits on the meter	Pa_ sum=Rx	kW	Float	R
2026H - 2027H	8230 - 8231	Phase B inline Real Powe	Sum of Phase B real power for all circuits on the meter	Pb_ sum=Rx	kW	Float	R

Address (H)	Address (D)	Parameters	Description	Relationship	Property	Data Type	Access Property
2028H - 2029H	8232 - 8233	Phase C inline Real Power	Sum of Phase C real power for all circuits on the meter	Pc_ sum=Rx	kW	Float	R
202AH - 202BH	8234 - 8235	Phase A inline Reactive Power	Sum of Phase A reactive power for all circuits on the meter	Qa_ sum=Rx	kvar	Float	R
202CH - 202DH	8236 - 8237	Phase B inline Reactive Power	Sum of Phase B reactive power for all circuits on the meter	Qb_ sum=Rx	kvar	Float	R
202EH - 202FH	8238 - 8239	Phase C inline Reactive Power	Sum of Phase C reactive power for all circuits on the meter	Qc_ sum=Rx	kvar	Float	R
2030H - 2031H	8240 - 8241	Phase A inline Apparent Power	Sum of Phase A apparent power for all circuits on the meter	Sa_ sum=Rx	kVA	Float	R
2032H - 2033H	8242 - 8243	Phase B inline Apparent Power	Sum of Phase B apparent power for all circuits on the meter	Sb_ sum=Rx	kVA	Float	R
2034H - 2035H	8244 - 8245	Phase C inline Apparent Power	Sum of Phase C apparent power for all circuits on the meter	Sc_ sum=Rx	kVA	Float	R
2036H - 2037H	8246 - 8247	Phase A inline Power Factor	Average of the Phase A Power Factor for all circuits on the meter	PFa=Rx		Float	R

Address (H)	Address (D)	Parameters	Description	Relationship	Property	Data Type	Access Property
2038H - 2039H	8248 - 8249	Phase B inline Power Factor	Average of the Phase B Power Factor for all circuits on the meter	Pfb=Rx		Float	R
203AH - 203BH	8250 - 8251	Phase C inline Power Factor	Average of the Phase C Power Factor for all circuits on the meter	Pfc=Rx		Float	R
203CH - 203DH	8252 - 8253	Phase A inline Load Nature	Average of the Phase A Load Nature for all circuits on the meter	LCa=Rx		Float	R
203EH - 203FH	8254 - 8255	Phase B inline Load Nature	Average of the Phase B Load Nature for all circuits on the meter	LCb=Rx		Float	R
2040H - 2041H	8256 - 8257	Phase C inline Load Nature	Average of the Phase C Load Nature for all circuits on the meter	LCc=Rx		Float	R
Single-Phase data and Three-Phase / Single-Three Data							
2100H - 2101H	8448 - 8449	Channel 1 Current	Single Phase: Total current in circuit 1 Three Phase/ Single Phase-three wire: Phase A current in circuit 1	I1=Rx	A	Float	R

Address (H)	Address (D)	Parameters	Description	Relationship	Property	Data Type	Access Property
2102H - 2103H	8450 - 8451	Channel 1 Real Power	Single Phase: Total system power in circuit 1 Three Phase/Single Phase-three wire: Phase A real power in circuit 1	P1=Rx	kW	Float	R
2104H - 2105H	8452 - 8453	Channel 1 Reactive Power	Single Phase: Total reactive power in circuit 1 Three Phase/Single Phase-three wire: Phase A reactive power in circuit 1	Q1=Rx	kvar	Float	R
2106H - 2107H	8454 - 8455	Channel 1 Apparent Power	Single Phase: Total apparent power in circuit 1 Three Phase/Single Phase-three wire: Phase A apparent power in circuit 1	S1=Rx	kVA	Float	R
2108H - 2109H	8456 - 8457	Channel 1 Power Factor	Single Phase: Total power factor in circuit 1 Three Phase/Single Phase-three wire: Phase A power factor in circuit 1	PF1=Rx		Float	R
210AH - 210BH	8458 - 8459	Channel 1 Load Nature	Single Phase: Load nature of circuit 1 Three Phase/Single Phase-three wire: Phase A load nature of circuit 1	LC1=Rx		Float	R

Address (H)	Address (D)	Parameters	Description	Relationship	Property	Data Type	Access Property
210CH - 210DH	8460 - 8461	Channel 2 Current	Single Phase: Total current in circuit 2 Three Phase/Single Phase-three wire: Phase B current in circuit 1	I2=Rx	A	Float	R
210EH - 210FH	8462 - 8463	Channel 2 Real Power	Single Phase: Total system power in circuit 2 Three Phase/Single Phase-three wire: Phase B real power in circuit 1	P2=Rx	kW	Float	R
2110H - 2111H	8464 - 8465	Channel 2 Reactive Power	Single Phase: Total reactive power in circuit 2 Three Phase/Single Phase-three wire: Phase B reactive power in circuit 1	Q2=Rx	kvar	Float	R
2112H - 2113H	8466 - 8467	Channel 2 Apparent Power	Single Phase: Total apparent power in circuit 2 Three Phase/Single Phase-three wire: Phase B apparent power in circuit 1	S2=Rx	kVA	Float	R
2114H - 2115H	8468 - 8469	Channel 2 Power Factor	Single Phase: Total power factor in circuit 2 Three Phase/Single Phase-three wire: Phase B power factor in circuit 1	PF2=Rx		Float	R

Address (H)	Address (D)	Parameters	Description	Relationship	Property	Data Type	Access Property
2116H - 2117H	8470 - 8471	Channel 2 Load Nature	Single Phase: Load nature of circuit 2 Three Phase/Single Phase-three wire: Phase B load nature of circuit 1	LC2=Rx		Float	R
2118H - 2119H	8472 - 8473	Channel 3 Current	Single Phase: Total current in circuit 3 Three Phase/Single Phase-three wire: Phase C current in circuit 1	I3=Rx	A	Float	R
211AH - 211BH	8474 - 8475	Channel 3 Real Power	Single Phase: Total power in circuit 3 Three Phase/Single Phase-three wire: Phase C power in circuit 1	P3=Rx	kW	Float	R
211CH - 211DH	8476 - 8477	Channel 3 Reactive Power	Single Phase: Total reactive power in circuit 3 Three Phase/Single Phase-three wire: Phase C reactive power in circuit 1	Q3=Rx	kvar	Float	R
211EH - 211FH	8478 - 8479	Channel 3 Apparent Power	Single Phase: Total apparent power in circuit 3 Three Phase/Single Phase-three wire: Phase C apparent power in circuit 1	S3=Rx	kVA	Float	R

Address (H)	Address (D)	Parameters	Description	Relationship	Property	Data Type	Access Property
2120H - 2121H	8480 - 8481	Channel 3 Power Factor	Single Phase: Total power factor in circuit 3 Three Phase/Single Phase-three wire: Phase C power factor in circuit 1	PF3=Rx		Float	R
2122H - 2123H	8482 - 8483	Channel 3 Load Nature	Single Phase: Load nature of circuit 3 Three Phase/Single Phase-three wire: Phase C load nature of circuit 1	LC3=Rx		Float	R
2124H - 2125H	8484 - 8485	Channel 4 Current	Single Phase: Total current in circuit 4 Three Phase/Single Phase-three wire: Phase A current in circuit 2	I4=Rx	A	Float	R
2126H - 2127H	8486 - 8487	Channel 4 Real Power	Single Phase: Total power in circuit 4 Three Phase/Single Phase-three wire: Phase A power in circuit 2	P4=Rx	kW	Float	R
2128H - 2129H	8488 - 8489	Channel 4 Reactive Power	Single Phase: Total reactive power in circuit 4 Three Phase/Single Phase-three wire: Phase A reactive power in circuit 2	Q4=Rx	kvar	Float	R

Address (H)	Address (D)	Parameters	Description	Relationship	Property	Data Type	Access Property
212AH - 212BH	8490 - 8491	Channel 4 Apparent Power	Single Phase: Total apparent power in circuit 4 Three Phase/Single Phase- three wire: Phase A apparent power in circuit 2	S4=Rx	kVA	Float	R
212CH - 212DH	8492 - 8493	Channel 4 Power Factor	Single Phase: Total power factor in circuit 4 Three Phase/Single Phase- three wire: Phase A power factor in circuit 2	PF4=Rx		Float	R
212EH - 212FH	8494 - 8495	Channel 4 Load Nature	Single Phase: Load nature of circuit 4 Three Phase/Single Phase-three wire: Phase A load nature of circuit 2	LC4=Rx		Float	R
2130H - 2131H	8496 - 8497	Channel 5 Current	Single Phase: Total current in circuit 5 Three Phase/Single Phase-three wire: Phase B current in circuit 2	I5=Rx	A	Float	R
2132H - 2133H	8498 - 8499	Channel 5 Real Power	Single Phase: Total power in circuit 5 Three Phase/Single Phase-three wire: Phase B power in circuit 2	P5=Rx	kW	Float	R

Address (H)	Address (D)	Parameters	Description	Relationship	Property	Data Type	Access Property
2134H - 2135H	8500 - 8501	Channel 5 Reactive Power	Single Phase: Total reactive power in circuit 5 Three Phase/Single Phase-three wire: Phase B reactive power in circuit 2	Q5=Rx	kvar	Float	R
2136H - 2137H	8502 - 8503	Channel 5 Apparent Power	Single Phase: Total apparent power in circuit 5 Three Phase/Single Phase-three wire: Phase B apparent power in circuit 2	S5=Rx	kVA	Float	R
2138H - 2139H	8504 - 8505	Channel 5 Power Factor	Single Phase: Total power factor in circuit 5 Three Phase/Single Phase-three wire: Phase B power factor in circuit 2	PF5=Rx		Float	R
213AH - 213BH	8506 - 8507	Channel 5 Load Nature	Single Phase: Load nature of circuit 5 Three Phase/Single Phase-three wire: Phase B load nature of circuit 2	LC5=Rx		Float	R
213CH - 213DH	8508 - 8509	Channel 6 Current	Single Phase: Total current in circuit 6 Three Phase/Single Phase-three wire: Phase C current in circuit 2	I6=Rx	A	Float	R

Address (H)	Address (D)	Parameters	Description	Relationship	Property	Data Type	Access Property
213EH - 213FH	8510 - 8511	Channel 6 Real Power	Single Phase: Total power in circuit 6 Three Phase/Single Phase-three wire: Phase C power in circuit 2	P6=Rx	kW	Float	R
2140H - 2141H	8512 - 8513	Channel 6 Reactive Power	Single Phase: Total reactive power in circuit 6 Three Phase/Single Phase-three wire: Phase C reactive power in circuit 2	Q6=Rx	kvar	Float	R
2142H - 2143H	8514 - 8515	Channel 6 Apparent Power	Single Phase: Total apparent power in circuit 6 Three Phase/Single Phase-three wire: Phase C apparent power in circuit 2	S6=Rx	kVA	Float	R
2144H - 2145H	8516 - 8517	Channel 6 Power Factor	Single Phase: Total power factor in circuit 6 Three Phase/Single Phase-three wire: Phase C power factor in circuit 2	PF6=Rx		Float	R
2146H - 2147H	8518 - 8519	Channel 6 Load Nature	Single Phase: Load nature of circuit 6 Three Phase/Single Phase-three wire: Phase C load nature of circuit 2	LC6=Rx		Float	R

Address (H)	Address (D)	Parameters	Description	Relationship	Property	Data Type	Access Property
2148H - 2149H	8520 - 8521	Channel 7 Current	Single Phase: Total current in circuit 7 Three Phase/Single Phase-three wire: Phase A current in circuit 3	I7=Rx	A	Float	R
214AH - 214BH	8522 - 8523	Channel 7 Real Power	Single Phase: Total power in circuit 7 Three Phase/Single Phase-three wire: Phase A power in circuit 3	P7=Rx	kW	Float	R
214CH - 214DH	8524 - 8525	Channel 7 Reactive Power	Single Phase: Total reactive power in circuit 7 Three Phase/Single Phase-three wire: Phase A reactive power in circuit 3	Q7=Rx	kvar	Float	R
214EH - 214FH	8526 - 8527	Channel 7 Apparent Power	Single Phase: Total apparent power in circuit 7 Three Phase/Single Phase-three wire: Phase A apparent power in circuit 3	S7=Rx	kVA	Float	R
2150H - 2151H	8528 - 8529	Channel 7 Power Factor	Single Phase: Total power factor in circuit 7 Three Phase/Single Phase-three wire: Phase A power factor in circuit 3	PF7=Rx		Float	R

Address (H)	Address (D)	Parameters	Description	Relationship	Property	Data Type	Access Property
2152H - 2153H	8530 - 8531	Channel 7 Load Nature	Single Phase: Load nature of circuit 7 Three Phase/Single Phase-three wire: Phase A load nature of circuit 3	LC7=Rx		Float	R
2154H - 2155H	8532 - 8533	Channel 8 Current	Single Phase: Total current in circuit 8 Three Phase/Single Phase-three wire: Phase B current in circuit 3	I8=Rx	A	Float	R
2156H - 2157H	8534 - 8535	Channel 8 Real Power	Single Phase: Total power in circuit 8 Three Phase/Single Phase-three wire: Phase B power in circuit 3	P8=Rx	kW	Float	R
2158H - 2159H	8536 - 8537	Channel 8 Reactive Power	Single Phase: Total reactive power in circuit 8 Three Phase/Single Phase-three wire: Phase B reactive power in circuit 3	Q8=Rx	kvar	Float	R
215AH - 215BH	8538 - 8539	Channel 8 Apparent Power	Single Phase: Total apparent power in circuit 8 Three Phase/Single Phase-three wire: Phase B apparent power in circuit 3	S8=Rx	kVA	Float	R

Address (H)	Address (D)	Parameters	Description	Relationship	Property	Data Type	Access Property
215CH - 215DH	8540 - 8541	Channel 8 Power Factor	Single Phase: Total power factor in circuit 8 Three Phase/Single Phase-three wire: Phase B power factor in circuit 3	PF8=Rx		Float	R
215EH - 215FH	8542 - 8543	Channel 8 Load Nature	Single Phase: Load nature of circuit 8 Three Phase/Single Phase-three wire: Phase B load nature of circuit 3	LC8=Rx		Float	R
2160H - 2161H	8544 - 8545	Channel 9 Current	Single Phase: Total current in circuit 9 Three Phase/Single Phase-three wire: Phase C current in circuit 3	I9=Rx	A	Float	R
2162H - 2163H	8546 - 8547	Channel 9 Real Power	Single Phase: Total power in circuit 9 Three Phase/Single Phase-three wire: Phase C power in circuit 3	P9=Rx	kW	Float	R
2164H - 2165H	8548 - 8549	Channel 9 Reactive Power	Single Phase: Total reactive power in circuit 9 Three Phase/Single Phase-three wire: Phase C reactive power in circuit 3	Q9=Rx	kvar	Float	R

Address (H)	Address (D)	Parameters	Description	Relationship	Property	Data Type	Access Property
2166H - 2167H	8550 - 8551	Channel 9 Apparent Power	Single Phase: Total apparent power in circuit 9 Three Phase/Single Phase- three wire: Phase C apparent power in circuit 3	S9=Rx	kVA	Float	R
2168H - 2169H	8552 - 8553	Channel 9 Power Factor	Single Phase: Total power factor in circuit 9 Three Phase/Single Phase- three wire: Phase C power factor in circuit 3	PF9=Rx		Float	R
216AH - 216BH	8554 - 8555	Channel 9 Load Nature	Single Phase: Load nature of circuit 9 Three Phase/ Single Phase-three wire: Phase C load nature of circuit 3	LC9=Rx		Float	R
216CH - 216DH	8556 - 8557	Channel 10 Current	Single Phase: Total current in circuit 10 Three Phase/Single Phase-three wire: Phase A current in circuit 4	I10=Rx	A	Float	R
216EH - 216FH	8558 - 8559	Channel 10 Real Power	Single Phase: Total power in circuit 10 Three Phase/Single Phase-three wire: Phase A power in circuit 4	P10=Rx	kW	Float	R

Address (H)	Address (D)	Parameters	Description	Relationship	Property	Data Type	Access Property
2170H - 2171H	8560 - 8561	Channel 10 Reactive Power	Single Phase: Total reactive power in circuit 10 Three Phase/Single Phase-three wire: Phase A reactive power in circuit 4	Q10=Rx	kvar	Float	R
2172H - 2173H	8562 - 8563	Channel 10 Apparent Power	Single Phase: Total apparent power in circuit 10 Three Phase/Single Phase-three wire: Phase A apparent power in circuit 4	S10=Rx	kVA	Float	R
2174H - 2175H	8564 - 8565	Channel 10 Power Factor	Single Phase: Total power factor in circuit 10 Three Phase/Single Phase-three wire: Phase A power factor in circuit 4	PF10=Rx		Float	R
2176H - 2177H	8566 - 8567	Channel 10 Load Nature	Single Phase: Load nature of circuit 10 Three Phase/Single Phase-three wire: Phase A load nature of circuit 4	LC10=Rx		Float	R
2178H - 2179H	8568 - 8569	Channel 11 Current	Single Phase: Total current in circuit 11 Three Phase/Single Phase-three wire: Phase B current in circuit 4	I11=Rx	A	Float	R

Address (H)	Address (D)	Parameters	Description	Relationship	Property	Data Type	Access Property
217AH - 217BH	8570 - 8571	Channel 11 Real Power	Single Phase: Total power in circuit 11 Three Phase/Single Phase-three wire: Phase B power in circuit 4	P11=Rx	kW	Float	R
217CH - 217DH	8572 - 8573	Channel 11 Reactive Power	Single Phase: Total reactive power in circuit 11 Three Phase/Single Phase-three wire: Phase B reactive power in circuit 4	Q11=Rx	kvar	Float	R
217EH - 217FH	8574 - 8575	Channel 11 Apparent Power	Single Phase: Total apparent power in circuit 11 Three Phase/Single Phase-three wire: Phase B apparent power in circuit 4	S11=Rx	kVA	Float	R
2180H - 2181H	8576 - 8577	Channel 11 Power Factor	Single Phase: Total power factor in circuit 11 Three Phase/Single Phase-three wire: Phase B power factor in circuit 4	PF11=Rx		Float	R
2182H - 2183H	8578 - 8579	Channel 11 Load Nature	Single Phase: Load nature of circuit 11 Three Phase/Single Phase-three wire: Phase B load nature of circuit 4	LC11=Rx		Float	R

Address (H)	Address (D)	Parameters	Description	Relationship	Property	Data Type	Access Property
2184H - 2185H	8580 - 8581	Channel 12 Current	Single Phase: Total current in circuit 12 Three Phase/Single Phase-three wire: Phase C current in circuit 4	I12=Rx	A	Float	R
2186H - 2187H	8582 - 8583	Channel 12 Real Power	Single Phase: Total power in circuit 12 Three Phase/Single Phase-three wire: Phase C power in circuit 4	P12=Rx	kW	Float	R
2188H - 2189H	8584 - 8585	Channel 12 Reactive Power	Single Phase: Total reactive power in circuit 12 Three Phase/Single Phase-three wire: Phase C reactive power in circuit 4	Q12=Rx	kvar	Float	R
218AH - 218BH	8586 - 8587	Channel 12 Apparent Power	Single Phase: Total apparent power in circuit 12 Three Phase/Single Phase-three wire: Phase C apparent power in circuit 4	S12=Rx	kVA	Float	R
218CH - 218DH	8588 - 8589	Channel 12 Power Factor	Single Phase: Total power factor in circuit 12 Three Phase/Single Phase-three wire: Phase C power factor in circuit 4	PF12=Rx		Float	R

Address (H)	Address (D)	Parameters	Description	Relationship	Property	Data Type	Access Property
218EH - 218FH	8590 - 8591	Channel 12 Load Nature	Single Phase: Load nature of circuit 12 Three Phase/Single Phase-three wire: Phase C load nature of circuit 4	LC12=Rx		Float	R
2190H - 2191H	8592 - 8593	Channel 13 Current	Single Phase: Total current in circuit 13 Three Phase/Single Phase-three wire: Phase A current in circuit 5	I13=Rx	A	Float	R
2192H - -2193H	8594 - 8595	Channel 13 Real Power	Single Phase: Total power in circuit 13 Three Phase/Single Phase-three wire: Phase A power in circuit 5	P13=Rx	kW	Float	R
2194H - 2195H	8596 - 8597	Channel 13 Reactive Power	Single Phase: Total reactive power in circuit 13 Three Phase/Single Phase-three wire: Phase A reactive power in circuit 5	Q13=Rx	kvar	Float	R
2196H - 2197H	8598 - 8599	Channel 13 Apparent Power	Single Phase: Total apparent power in circuit 13 Three Phase/Single Phase-three wire: Phase A apparent power in circuit 5	S13=Rx	kVA	Float	R

Address (H)	Address (D)	Parameters	Description	Relationship	Property	Data Type	Access Property
2198H - 2199H	8600 - 8601	Channel 13 Power Factor	Single Phase: Total power factor in circuit 13 Three Phase/Single Phase-three wire: Phase A power factor in circuit 5	PF13=Rx		Float	R
219AH - 219BH	8602 - 8603	Channel 13 Load Nature	Single Phase: Load nature of circuit 13 Three Phase/Single Phase-three wire: Phase A load nature of circuit 5	LC13=Rx		Float	R
219CH - 219DH	8604 - 8605	Channel 14 Current	Single Phase: Total current in circuit 14 Three Phase/Single Phase-three wire: Phase B current in circuit 5	I14=Rx	A	Float	R
219EH - 219FH	8606 - 8607	Channel 14 Real Power	Single Phase: Total power in circuit 14 Three Phase/Single Phase-three wire: Phase B power in circuit 5	P14=Rx	kW	Float	R
21A0H - 21A1H	8608 - 8609	Channel 14 Reactive Power	Single Phase: Total reactive power in circuit 14 Three Phase/Single Phase-three wire: Phase B reactive power in circuit 5	Q14=Rx	kvar	Float	R

Address (H)	Address (D)	Parameters	Description	Relationship	Property	Data Type	Access Property
21A2H - 21A3H	8610 - 8611	Channel 14 Apparent Power	Single Phase: Total apparent power in circuit 14 Three Phase/Single Phase- three wire: Phase B apparent power in circuit 5	S14=Rx	kVA	Float	R
21A4H - 21A5H	8612 - 8613	Channel 14 Power Factor	Single Phase: Total power factor in circuit 14 Three Phase/Single Phase- three wire: Phase B power factor in circuit 5	PF14=Rx		Float	R
21A6H - 21A7H	8614 - 8615	Channel 14 Load Nature	Single Phase: Load nature of circuit 14 Three Phase/Single Phase-three wire: Phase B load nature of circuit 5	LC14=Rx		Float	R
21A8H - 21A9H	8616 - 8617	Channel 15 Current	Single Phase: Total current in circuit 15 Three Phase/Single Phase-three wire: Phase C current in circuit 5	I15=Rx	A	Float	R
21AAH - 21ABH	8618 - 8619	Channel 15 Real Power	Single Phase: Total power in circuit 15 Three Phase/Single Phase-three wire: Phase C power in circuit 5	P15=Rx	kW	Float	R

Address (H)	Address (D)	Parameters	Description	Relationship	Property	Data Type	Access Property
21ACH - 21ADH	8620 - 8621	Channel 15 Reactive Power	Single Phase: Total reactive power in circuit 15 Three Phase/Single Phase-three wire: Phase C reactive power in circuit 5	Q15=Rx	kvar	Float	R
21AEH - 21AFH	8622 - 8623	Channel 15 Apparent Power	Single Phase: Total apparent power in circuit 15 Three Phase/Single Phase-three wire: Phase C apparent power in circuit 5	S15=Rx	kVA	Float	R
21B0H - 21B1H	8624 - 8625	Channel 15 Power Factor	Single Phase: Total power factor in circuit 15 Three Phase/Single Phase-three wire: Phase C power factor in circuit 5	PF15=Rx		Float	R
21B2H - 21B3H	8626 - 8627	Channel 15 Load Nature	Single Phase: Load nature of circuit 15 Three Phase/Single Phase-three wire: Phase C load nature of circuit 5	LC15=Rx		Float	R
21B4H - 21B5H	8628 - 8629	Channel 16 Current	Single Phase: Total current in circuit 16 Three Phase/Single Phase-three wire: Phase A current in circuit 6	I16=Rx	A	Float	R

Address (H)	Address (D)	Parameters	Description	Relationship	Property	Data Type	Access Property
21B6H - 21B7H	8630 - 8631	Channel 16 Real Power	Single Phase: Total power in circuit 16 Three Phase/Single Phase-three wire: Phase A power in circuit 6	P16=Rx	kW	Float	R
21B8H - 21B9H	8632 - 8633	Channel 16 Reactive Power	Single Phase: Total reactive power in circuit 16 Three Phase/Single Phase-three wire: Phase A reactive power in circuit 6	Q16=Rx	kvar	Float	R
21BAH - 21BBH	8634 - 8635	Channel 16 Apparent Power	Single Phase: Total apparent power in circuit 16 Three Phase/Single Phase-three wire: Phase A apparent power in circuit 6	S16=Rx	kVA	Float	R
21BCH - 21BDH	8636 - 8637	Channel 16 Power Factor	Single Phase: Total power factor in circuit 16 Three Phase/Single Phase-three wire: Phase A power factor in circuit 6	PF16=Rx		Float	R
21BEH - 21BFH	8638 - 8639	Channel 16 Load Nature	Single Phase: Load nature of circuit 16 Three Phase/Single Phase-three wire: Phase A load nature of circuit 6	LC16=Rx		Float	R

Address (H)	Address (D)	Parameters	Description	Relationship	Property	Data Type	Access Property
21C0H - 21C1H	8640 - 8641	Channel 17 Current	Single Phase: Total current in circuit 17 Three Phase/Single Phase-three wire: Phase B current in circuit 6	I17=Rx	A	Float	R
21C2H - 21C3H	8642 - 8643	Channel 17 Real Power	Single Phase: Total power in circuit 17 Three Phase/Single Phase-three wire: Phase B power in circuit 6	P17=Rx	kW	Float	R
21C4H - 21C5H	8644 - 8645	Channel 17 Reactive Power	Single Phase: Total reactive power in circuit 17 Three Phase/Single Phase-three wire: Phase B reactive power in circuit 6	Q17=Rx	kvar	Float	R
21C6H - 21C7H	8646 - 8647	Channel 17 Apparent Power	Single Phase: Total apparent power in circuit 17 Three Phase/Single Phase-three wire: Phase B apparent power in circuit 6	S17=Rx	kVA	Float	R
21C8H - 21C9H	8648 - 8649	Channel 17 Power Factor	Single Phase: Total power factor in circuit 17 Three Phase/Single Phase-three wire: Phase B power factor in circuit 6	PF17=Rx		Float	R

Address (H)	Address (D)	Parameters	Description	Relationship	Property	Data Type	Access Property
21CAH - 21CBH	8650 - 8651	Channel 17 Load Nature	Single Phase: Load nature of circuit 17 Three Phase/Single Phase-three wire: Phase B load nature of circuit 6	LC17=Rx		Float	R
21CCH - 21CDH	8652 - 8653	Channel 18 Current	Single Phase: Total current in circuit 18 Three Phase/Single Phase-three wire: Phase C current in circuit 6	I18=Rx	A	Float	R
21CEH - 21CFH	8654 - 8655	Channel 18 Real Power	Single Phase: Total power in circuit 18 Three Phase/Single Phase-three wire: Phase C power in circuit 6	P18=Rx	kW	Float	R
21D0H - 21D1H	8656 - 8657	Channel 18 Reactive Power	Single Phase: Total reactive power in circuit 18 Three Phase/Single Phase-three wire: Phase C reactive power in circuit 6	Q18=Rx	kvar	Float	R
21D2H - 21D3H	8658 - 8659	Channel 18 Apparent Power	Single Phase: Total apparent power in circuit 18 Three Phase/Single Phase-three wire: Phase C apparent power in circuit 6	S18=Rx	kVA	Float	R

Address (H)	Address (D)	Parameters	Description	Relationship	Property	Data Type	Access Property
21D4H - 21D5H	8660 - 8661	Channel 18 Power Factor	Single Phase: Total power factor in circuit 18 Three Phase/Single Phase-three wire: Phase C power factor in circuit 6	PF18=Rx		Float	R
21D6H - 21D7H	8662 - 8663	Channel 18 Load Nature	Single Phase: Load nature of circuit 18 Three Phase/Single Phase-three wire: Phase C load nature of circuit 6	LC18=Rx		Float	R
21D8H - 21D9H	8664 - 8665	User Channel 1 Three Phase Active Power	Total Active Power for 1st three phase/single phase three wire circuit.	Ps1=Rx	kW	Float	R
21DAH - 21DBH	8666 - 8667	User Channel 1 Three Phase Reactive Power	Total Reactive Power for 1st three phase/single phase three wire circuit.	Qs1=Rx	kvar	Float	R
21DCH - 21DDH	8668 - 8669	User Channel 1 Three Phase Apparent Power	Total Apparent Power for 1st three phase/single phase three wire circuit.	Ss1=Rx	kVA	Float	R
21DEH - 21DFH	8670 - 8671	User Channel 1 Three Phase Power Factor	Total Power Factor for 1st three phase/single phase three wire circuit	PFs1=Rx		Float	R

Address (H)	Address (D)	Parameters	Description	Relationship	Property	Data Type	Access Property
21E0H - 21E1H	8672 - 8673	User Channel 1 Three Phase Load Nature	Total Load Nature for 1st three phase/single phase three wire circuit	LCs1=Rx		Float	R
21E2H - 21E3H	8674 - 8675	User Channel 2 Three Phase Active Power	Total Active Power for 2nd three phase/single phase three wire circuit.	Ps2=Rx	kW	Float	R
21E4H - 21E5H	8676 - 8677	User Channel 2 Three Phase Reactive Power	Total Reactive Power for 2nd three phase/single phase three wire circuit.	Qs2=Rx	kvar	Float	R
21E6H - 21E7H	8678 - 8679	User Channel 2 Three Phase Apparent Power	Total Apparent Power for 2nd three phase/single phase three wire circuit.	Ss2=Rx	kVA	Float	R
21E8H - 21E9H	8680 - 8681	User Channel 2 Three Phase Power Factor	Total Power Factor for 2nd three phase/single phase three wire circuit	PFs2=Rx		Float	R
21EAH - 21EBH	8682 - 8683	User Channel 2 Three Phase Load Nature	Total Load Nature for 2nd three phase/single phase three wire circuit	LCs2=Rx		Float	R

Address (H)	Address (D)	Parameters	Description	Relationship	Property	Data Type	Access Property
21ECH - 21EDH	8684 - 8685	User Channel 3 Three Phase Active Power	Total Active Power for 3rd three phase/single phase three wire circuit.	Ps3=Rx	kW	Float	R
21EEH - 21EFH	8686 - 8687	User Channel 3 Three Phase Reactive Power	Total Reactive Power for 3rd three phase/single phase three wire circuit.	Qs3=Rx	kvar	Float	R
21F0H - 21F1H	8688 - 8689	User Channel 3 Three Phase Apparent Power	Total Apparent Power for 3rd three phase/single phase three wire circuit.	Ss3=Rx	kVA	Float	R
21F2H - 21F3H	8690 - 8691	User Channel 3 Three Phase Power Factor	Total Power Factor for 3rd three phase/single phase three wire circuit	PFs3=Rx		Float	R
21F4H - 21F5H	8692 - 8693	User Channel 3 Three Phase Load Nature	Total Load Nature for 3rd three phase/single phase three wire circuit	LCs3=Rx		Float	R
21F6H - 21F7H	8694 - 8695	User Channel 4 Three Phase Active Power	Total Active Power for 4th three phase/single phase three wire circuit.	Ps4=Rx	kW	Float	R

Address (H)	Address (D)	Parameters	Description	Relationship	Property	Data Type	Access Property
21F8H - 21F9H	8696 - 8697	User Channel 4 Three Phase Reactive Power	Total Reactive Power for 4th three phase/single phase three wire circuit.	Qs4=Rx	kvar	Float	R
21FAH - 21FBH	8698 - 8699	User Channel 4 Three Phase Apparent Power	Total Apparent Power for 4th three phase/single phase three wire circuit.	Ss4=Rx	kVA	Float	R
21FCH - 21FDH	8700 - 8701	User Channel 4 Three Phase Power Factor	Total Power Factor for 4th three phase/ single phase three wire circuit	PFs4=Rx		Float	R
21FEH - 21FFH	8702 - 8703	User Channel 4 Three Phase Load Nature	Total Load Nature for 4th three phase/ single phase three wire circuit	LCs4=Rx		Float	R
2200H - 2201H	8704 - 8705	User Channel 5 Three Phase Active Power	Total Active Power for 5th three phase/ single phase three wire circuit.	Ps5=Rx	kW	Float	R
2202H - 2203H	8706 - 8707	User Channel 5 Three Phase Reactive Power	Total Reactive Power for 5th three phase/single phase three wire circuit.	Qs5=Rx	kvar	Float	R

Address (H)	Address (D)	Parameters	Description	Relationship	Property	Data Type	Access Property
2204H - 2205H	8708 - 8709	User Channel 5 Three Phase Apparent Power	Total Apparent Power for 5th three phase/single phase three wire circuit.	Ss5=Rx	kVA	Float	R
2206H - 2207H	8710 - 8711	User Channel 5 Three Phase Power Factor	Total Power Factor for 5th three phase/ single phase three wire circuit	PFs5=Rx		Float	R
2208H - 2209H	8712 - 8713	User Channel 5 Three Phase Load Nature	Total Load Nature for 5th three phase/ single phase three wire circuit	LCs5=Rx		Float	R
220AH - 220BH	8714 - 8715	User Channel 6 Three Phase Active Power	Total Active Power for 6th three phase/ single phase three wire circuit.	Ps6=Rx	kW	Float	R
220CH - 220DH	8716 - 8717	User Channel 6 Three Phase Reactive Power	Total Reactive Power for 6th three phase/single phase three wire circuit.	Qs6=Rx	kvar	Float	R
220EH - 220FH	8718 - 8719	User Channel 6 Three Phase Apparent Power	Total Apparent Power for 6th three phase/single phase three wire circuit.	Ss6=Rx	kVA	Float	R

Address (H)	Address (D)	Parameters	Description	Relationship	Property	Data Type	Access Property
2210H - 2211H	872 - 8721	User Channel 6 Three Phase Power Factor	Total Power Factor for 6th three phase/ single phase three wire circuit	PFs6=Rx		Float	R
2212H - 2213H	8722 - 8723	User Channel 6 Three Phase Load Nature	Total Load Nature for 6th three phase/ single phase three wire circuit	LCs6=Rx		Float	R
2214 - 2215	8724 - 8725	User Channel 7 Two Phase Active Power	Total Active Power for 7th two phase three wire circuit	Ps7=Rx	kW	Float	R
2216 - 2217	8726 - 8727	User Channel 7 Two Phase Reactive Power	Total Reactive Power for 7th two phase three wire circuit	Qs7=Rx	kvar	Float	R
2218 - 2219	8728 - 8729	User Channel 7 Two Phase Apparent Power	Total Apparent Power for 7th two phase three wire circuit	Ss7=Rx	kVA	Float	R
221A - 221B	8730 - 8731	User Channel 7 Two Phase Power Factor	Total Power Factor for 7th two phase three wire circuit	PFs7=Rx		Float	R

Address (H)	Address (D)	Parameters	Description	Relationship	Property	Data Type	Access Property
221C - 221D	8732 - 8733	User Channel 7 Two Phase Load Nature	Total Load Nature for 7th two phase three wire circuit	LCs7=Rx		Float	R
221E - 221F	8734 - 8735	User Channel 8 Two Phase Active Power	Total Active Power for 8th two phase three wire circuit	Ps8=Rx	kW	Float	R
2220 - 2221	8736 - 8737	User Channel 8 Two Phase Reactive Power	Total Reactive Power for 8th two phase three wire circuit	Qs8=Rx	kvar	Float	R
2222 - 2223	8738 - 8739	User Channel 8 Two Phase Apparent Power	Total Apparent Power for 8th two phase three wire circuit	Ss8=Rx	kVA	Float	R
2224 - 2225	8740 - 8741	User Channel 8 Two Phase Power Factor	Total Power Factor for 8th two phase three wire circuit	PFs8=Rx		Float	R
2226 - 2227	8742 - 8743	User Channel 8 Two Phase Load Nature	Total Load Nature for 8th two phase three wire circuit	LCs8=Rx		Float	R

Address (H)	Address (D)	Parameters	Description	Relationship	Property	Data Type	Access Property
2228 - 2229	8744 - 8745	User Channel 9 Two Phase Active Power	Total Active Power for 9th two phase three wire circuit	Ps9=Rx	kW	Float	R
222A - 222B	8746 - 8747	User Channel 9 Two Phase Reactive Power	Total Reactive Power for 9th two phase three wire circuit	Qs9=Rx	kvar	Float	R
222C - 222D	8748 - 8749	User Channel 9 Two Phase Apparent Power	Total Apparent Power for 9th two phase three wire circuit	Ss9=Rx	kVA	Float	R
222E - 222F	8750 - 8751	User Channel 9 Two Phase Power Factor	Total Power Factor for 9th two phase three wire circuit	PFs9=Rx		Float	R
2230 - 2231	8752 - 8753	User Channel 9 Two Phase Load Nature	Total Load Nature for 9th two phase three wire circuit	LCs9=Rx		Float	R

The maximum value range is 9 digits, and one decimal point is displayed

Active energy

Note: 0x03 Read, 16 (0x10) Write

Real-time Energy - Positive Active Energy

Address (H)	Address (D)	Parameters	Description	Relationship	Property	Data Type	Access Property
2500H - 2501H	9472 - 9473	Phase A inline Import Energy	Sum of all Phase A Consumed Energy for all circuits	EPa_ IMP=Rx/10	kWh	Dword	R/W
2502H - 2503H	9474 - 9475	Phase B inline Import Energy	Sum of all Phase B Consumed Energy for all circuits	EPb_ IMP=Rx/10	kWh	Dword	R/W
2504H - 2505H	9476 - 9477	Phase C inline Import Energy	Sum of all Phase C Consumed Energy for all circuits	EPc_ IMP=Rx/10	kWh	Dword	R/W
2506H - 2507H	9478 - 9479	Total Inline Import Energy	Sum of all Consumed Energy for all circuits	EP_ IMP=Rx/10	kWh	Dword	R/W
18 Single Phase + 6 Three - Phase / Single Three Real - time Positive Active Energy							
2508 - 2509	9480 - 9481	Channel 1 Import Energy	Single Phase: Total Import Energy in circuit 1 Three Phase/Single Phase-three wire: Phase A Import Energy in circuit 1	EP1_ IMP=Rx/10	kWh	Dword	R/W
250A - 250B	9482 - 9483	Channel 2 Import Energy	Single Phase: Total Import Energy in circuit 2 Three Phase/Single Phase-three wire: Phase B Import Energy in circuit 1	EP2_ IMP=Rx/10	kWh	Dword	R/W

Address (H)	Address (D)	Parameters	Description	Relationship	Property	Data Type	Access Property
250C - 250D	9484 - 9485	Channel 3 Import Energy	Single Phase: Total Import Energy in circuit 3 Three Phase/Single Phase-three wire: Phase C Import Energy in circuit 1	EP3_ IMP=Rx/10	kWh	Dword	R/W
250E - 250F	9486 - 9487	Channel 4 Import Energy	Single Phase: Total Import Energy in circuit 4 Three Phase/Single Phase-three wire: Phase A Import Energy in circuit 2	EP4_ IMP=Rx/10	kWh	Dword	R/W
2510 - 2511	9488 - 9489	Channel 5 Import Energy	Single Phase: Total Import Energy in circuit 5 Three Phase/Single Phase-three wire: Phase B Import Energy in circuit 2	EP5_ IMP=Rx/10	kWh	Dword	R/W
2512 - 2513	9490 - 9491	Channel 6 Import Energy	Single Phase: Total Import Energy in circuit 6 Three Phase/Single Phase-three wire: Phase C Import Energy in circuit 2	EP6_ IMP=Rx/10	kWh	Dword	R/W

Address (H)	Address (D)	Parameters	Description	Relationship	Property	Data Type	Access Property
2514 - 2515	9492 - 9493	Channel 7 Import Energy	Single Phase: Total Import Energy in circuit 7 Three Phase/Single Phase-three wire: Phase A Import Energy in circuit 3	EP7_ IMP=Rx/10	kWh	Dword	R/W
2516 - 2517	9494 - 9495	Channel 8 Import Energy	Single Phase: Total Import Energy in circuit 8 Three Phase/Single Phase-three wire: Phase B Import Energy in circuit 3	EP8_ IMP=Rx/10	kWh	Dword	R/W
2518 - 2519	9496 - 9497	Channel 9 Import Energy	Single Phase: Total Import Energy in circuit 9 Three Phase/Single Phase-three wire: Phase C Import Energy in circuit 3	EP9_ IMP=Rx/10	kWh	Dword	R/W
251A - 251B	9498 - 9499	Channel 10 Import Energy	Single Phase: Total Import Energy in circuit 10 Three Phase/Single Phase-three wire: Phase A Import Energy in circuit 4	EP10_ IMP=Rx/10	kWh	Dword	R/W

Address (H)	Address (D)	Parameters	Description	Relationship	Property	Data Type	Access Property
251C - 251D	9500 - 9501	Channel 11 Import Energy	Single Phase: Total Import Energy in circuit 11 Three Phase/Single Phase-three wire: Phase B Import Energy in circuit 4	EP11_ IMP=Rx/10	kWh	Dword	R/W
251E - 251F	9502 - 9503	Channel 12 Import Energy	Single Phase: Total Import Energy in circuit 12 Three Phase/Single Phase-three wire: Phase C Import Energy in circuit 4	EP12_ IMP=Rx/10	kWh	Dword	R/W
2520 - 2521	9504 - 9505	Channel 13 Import Energy	Single Phase: Total Import Energy in circuit 13 Three Phase/Single Phase-three wire: Phase B Import Energy in circuit 5	EP13_ IMP=Rx/10	kWh	Dword	R/W
2522 - 2523	9506 - 9507	Channel 14 Import Energy	Single Phase: Total Import Energy in circuit 14 Three Phase/Single Phase-three wire: Phase B Import Energy in circuit 5	EP14_ IMP=Rx/10	kWh	Dword	R/W

Address (H)	Address (D)	Parameters	Description	Relationship	Property	Data Type	Access Property
2514 - 2525	9508 - 9509	Channel 15 Import Energy	Single Phase: Total Import Energy in circuit 15 Three Phase/Single Phase-three wire: Phase C Import Energy in circuit 5	EP15_ IMP=Rx/10	kWh	Dword	R/W
2516 - 2527	9510 - 9511	Channel 16 Import Energy	Single Phase: Total Import Energy in circuit 16 Three Phase/Single Phase-three wire: Phase A Import Energy in circuit 6	EP16_ IMP=Rx/10	kWh	Dword	R/W
2528 - 2529	9512 - 9513	Channel 17 Import Energy	Single Phase: Total Import Energy in circuit 17 Three Phase/Single Phase-three wire: Phase B Import Energy in circuit 6	EP17_ IMP=Rx/10	kWh	Dword	R/W
252A - 252B	9514 - 9515	Channel 18 Import Energy	Single Phase: Total Import Energy in circuit 18 Three Phase/Single Phase-three wire: Phase C Import Energy in circuit 6	EP18_ IMP=Rx/10	kWh	Dword	R/W

Address (H)	Address (D)	Parameters	Description	Relationship	Property	Data Type	Access Property
252C - 252D	9516 - 9517	User Channel 1 Import Energy	Total Import Energy for the 1st three phase/single phase three wire circuit	EPs1_ IMP=Rx/10	kWh	Dword	R/W
252E - 252F	9518 - 9519	User Channel 2 Import Energy	Total Import Energy for the 2nd three phase/single phase three wire circuit	EPs2_ IMP=Rx/10	kWh	Dword	R/W
2530 - 2531	9520 - 9521	User Channel 3 Import Energy	Total Import Energy for the 3rd three phase/single phase three wire circuit	EPs3_ IMP=Rx/10	kWh	Dword	R/W
2532 - 2533	9522 - 9523	User Channel 4 Import Energy	Total Import Energy for the 4th three phase/single phase three wire circuit	EPs4_ IMP=Rx/10	kWh	Dword	R/W
2534 - 2535	9524 - 9525	User Channel 5 Import Energy	Total Import Energy for the 5th three phase/single phase three wire circuit	EPs5_ IMP=Rx/10	kWh	Dword	R/W
2536 - 2537	9526 - 9527	User Channel 6 Import Energy	Total Import Energy for the 6th three phase/single phase three wire circuit	EPs6_ IMP=Rx/10	kWh	Dword	R/W

Address (H)	Address (D)	Parameters	Description	Relationship	Property	Data Type	Access Property
2538 - 2539	9528 - 9529	User Channel 7 Import Energy	Total Import Energy for the 7th two phase three wire circuit	EPs7_ IMP=Rx/10	kWh	Dword	R/W
253A - 253B	9530 - 9531	User Channel 8 Import Energy	Total Import Energy for the 8th two phase three wire circuit	EPs8_ IMP=Rx/10	kWh	Dword	R/W
253C - 253D	9532 - 9533	User Channel 9 Import Energy	Total Import Energy for the 9th two phase three wire circuit	EPs9_ IMP=Rx/10	kWh	Dword	R/W

Reactive Energy

Address (H)	Address (D)	Parameters	Description	Relationship	Property	Data Type	Access Property
Incoming Reactive Energy							
2B00H - 2B01H	11008 - 11009	Phase A Inline Import Reactive Energy	Sum of all Phase A Consumed Reactive Energy for all circuits	EQa_ IMP=Rx/10	kvarh	Dword	R/W
2B02H - 2B03H	11010 - 11011	Phase B Inline Import Reactive Energy	Sum of all Phase B Consumed Reactive Energy for all circuits	EQb_ IMP=Rx/10	kvarh	Dword	R/W

Address (H)	Address (D)	Parameters	Description	Relationship	Property	Data Type	Access Property
2B04H - 2B05H	11012 - 11013	Phase C Inline Import Reactive Energy	Sum of all Phase C Consumed Reactive Energy for all circuits	EQc_ IMP=R _x /10	kvarh	Dword	R/W
2B06H - 2B07H	11014 - 11015	Total Inline Import Reactive Energy	Sum of all Consumed Reactive Energy for all circuits	EQ_ IMP=R _x /10	kvarh	Dword	R/W
18 Channel Single - Phase and 6 Three - Phase / Single Three Reactive Energy							
2B08H - 2B09H	11016 - 11017	Channel 1 Import Reactive Energy	Single Phase: Total Import Reactive Energy in circuit 1 Three Phase/Single Phase-three wire: Phase A Import Reactive Energy in circuit 1	EQ1_ IMP=R _x /10	kvarh	Dword	R/W
2B0AH - 2B0BH	11018 - 11019	Channel 2 Import Reactive Energy	Single Phase: Total Import Reactive Energy in circuit 2 Three Phase/Single Phase-three wire: Phase B Import Reactive Energy in circuit 1	EQ2_ IMP=R _x /10	kvarh	Dword	R/W

Address (H)	Address (D)	Parameters	Description	Relationship	Property	Data Type	Access Property
2B0CH - 2B0DH	11020 - 11021	Channel 3 Import Reactive Energy	Single Phase: Total Import Reactive Energy in circuit 3 Three Phase/Single Phase-three wire: Phase C Import Reactive Energy in circuit 1	EQ3_ IMP=R _x /10	kvarh	Dword	R/W
2B0EH - 2B0FH	11022 - 11023	Channel 4 Import Reactive Energy	Single Phase: Total Import Reactive Energy in circuit 4 Three Phase/Single Phase-three wire: Phase A Import Reactive Energy in circuit 2	EQ4_ IMP=R _x /10	kvarh	Dword	R/W
2B10H - 2B11H	11024 - 11025	Channel 5 Import Reactive Energy	Single Phase: Total Import Reactive Energy in circuit 5 Three Phase/Single Phase-three wire: Phase B Import Reactive Energy in circuit 2	EQ5_ IMP=R _x /10	kvarh	Dword	R/W

Address (H)	Address (D)	Parameters	Description	Relationship	Property	Data Type	Access Property
2B12H - 2B13H	11026 - 11027	Channel 6 Import Reactive Energy	Single Phase: Total Import Reactive Energy in circuit 6 Three Phase/Single Phase-three wire: Phase C Import Reactive Energy in circuit 2	EQ6_ IMP=Rx/10	kvarh	Dword	R/W
2B14H - 2B15H	11028 - 11029	Channel 7 Import Reactive Energy	Single Phase: Total Import Reactive Energy in circuit 7 Three Phase/Single Phase-three wire: Phase A Import Reactive Energy in circuit 3	EQ7_ IMP=Rx/10	kvarh	Dword	R/W
2B16H - 2B17H	11030 - 11031	Channel 8 Import Reactive Energy	Single Phase: Total Import Reactive Energy in circuit 8 Three Phase/Single Phase-three wire: Phase B Import Reactive Energy in circuit 3	EQ8_ IMP=Rx/10	kvarh	Dword	R/W

Address (H)	Address (D)	Parameters	Description	Relationship	Property	Data Type	Access Property
2B18H - 2B19H	11032 - 11033	Channel 9 Import Reactive Energy	Single Phase: Total Import Reactive Energy in circuit 9 Three Phase/Single Phase-three wire: Phase C Import Reactive Energy in circuit 3	EQ9_ IMP=Rx/10	kvarh	Dword	R/W
2B1AH - 2B1BH	11034 - 11035	Channel 10 Import Reactive Energy	Single Phase: Total Import Reactive Energy in circuit 10 Three Phase/Single Phase-three wire: Phase A Import Reactive Energy in circuit 4	EQ10_ IMP=Rx/10	kvarh	Dword	R/W
2B1CH - 2B1DH	11036 - 11037	Channel 11 Import Reactive Energy	Single Phase: Total Import Reactive Energy in circuit 11 Three Phase/Single Phase-three wire: Phase B Import Reactive Energy in circuit 4	EQ11_ IMP=Rx/10	kvarh	Dword	R/W

Address (H)	Address (D)	Parameters	Description	Relationship	Property	Data Type	Access Property
2B1EH - 2B1FH	11038 - 11039	Channel 12 Import Reactive Energy	Single Phase: Total Import Reactive Energy in circuit 12 Three Phase/Single Phase-three wire: Phase C Import Reactive Energy in circuit 4	EQ12_ IMP=Rx/10	kvarh	Dword	R/W
2B20H - 2B21H	11040 - 11041	Channel 13 Import Reactive Energy	Single Phase: Total Import Reactive Energy in circuit 13 Three Phase/Single Phase-three wire: Phase A Import Reactive Energy in circuit 5	EQ13_ IMP=Rx/10	kvarh	Dword	R/W
2B22H - 2B23H	11042 - 11043	Channel 14 Import Reactive Energy	Single Phase: Total Import Reactive Energy in circuit 14 Three Phase/Single Phase-three wire: Phase B Import Reactive Energy in circuit 5	EQ14_ IMP=Rx/10	kvarh	Dword	R/W

Address (H)	Address (D)	Parameters	Description	Relationship	Property	Data Type	Access Property
2B24H - 2B25H	11044 - 11045	Channel 15 Import Reactive Energy	Single Phase: Total Import Reactive Energy in circuit 15 Three Phase/Single Phase-three wire: Phase C Import Reactive Energy in circuit 5	EQ15_ IMP=R _x /10	kvarh	Dword	R/W
2B26H - 2B27H	11046 - 11047	Channel 16 Import Reactive Energy	Single Phase: Total Import Reactive Energy in circuit 16 Three Phase/Single Phase-three wire: Phase A Import Reactive Energy in circuit 6	EQ16_ IMP=R _x /10	kvarh	Dword	R/W
2B28H - 2B29H	11048 - 11049	Channel 17 Import Reactive Energy	Single Phase: Total Import Reactive Energy in circuit 17 Three Phase/Single Phase-three wire: Phase B Import Reactive Energy in circuit 6	EQ17_ IMP=R _x /10	kvarh	Dword	R/W

Address (H)	Address (D)	Parameters	Description	Relationship	Property	Data Type	Access Property
2B2AH - 2B2BH	11050 - 11051	Channel 18 Import Reactive Energy	Single Phase: Total Import Reactive Energy in circuit 18 Three Phase/Single Phase-three wire: Phase C Import Reactive Energy in circuit 6	EQ18_ IMP=Rx/10	kvarh	Dword	R/W
2B2CH - 2B2DH	11052 - 11053	User Channel 1 Import Reactive Energy	Total Import Reactive Energy for the 1st three phase/single phase three wire circuit	EQs1_ IMP=Rx/10	kvarh	Dword	R/W
2B2EH - 2B2FH	11054 - 11055	User Channel 2 Import Reactive Energy	Total Import Reactive Energy for the 2nd three phase/single phase three wire circuit	EQs2_ IMP=Rx/10	kvarh	Dword	R/W
2B30H - 2B31H	11056 - 11057	User Channel 3 Import Reactive Energy	Total Import Reactive Energy for the 3rd three phase/single phase three wire circuit	EQs3_ IMP=Rx/10	kvarh	Dword	R/W
2B32H - 2B33H	11058 - 11059	User Channel 4 Import Reactive Energy	Total Import Reactive Energy for the 4th three phase/single phase three wire circuit	EQs4_ IMP=Rx/10	kvarh	Dword	R/W

Address (H)	Address (D)	Parameters	Description	Relationship	Property	Data Type	Access Property
2B34H - 2B35H	11060 - 11061	User Channel 5 Import Reactive Energy	Total Import Reactive Energy for the 5th three phase/single phase three wire circuit	EQs5_ IMP=Rx/10	kvarh	Dword	R/W
2B36H - 2B37H	11062 - 11063	User Channel 6 Import Reactive Energy	Total Import Reactive Energy for the 6th three phase/single phase three wire circuit	EQs6_ IMP=Rx/10	kvarh	Dword	R/W
2B70- 2B71	11120 - 11121	User Channel 7 Import Reactive Energy	Total Import Reactive Energy for the 7th two phase three wire circuit	EQs7_ IMP=Rx/10	kvarh	Dword	R/W
2B72- 2B73	11122- 11123	User Channel 8 Import Reactive Energy	Total Import Reactive Energy for the 8th two phase three wire circuit	EQs8_ IMP=Rx/10	kvarh	Dword	R/W
2B74- 2B75	11124- 11125	User Channel 9 Import Reactive Energy	Total Import Reactive Energy for the 9th two phase three wire circuit	EQs9_ IMP=Rx/10	kvarh	Dword	R/W

Apparent Energy

Address (H)	Address (D)	Parameter	Description	Relationship	Property	Data Type	Access Property
Incoming Apparent Energy							
2B38H - 2B39H	11064 - 11065	Phase A Inline Apparent Energy	Sum of all Phase A Apparent Energy for all circuits	ESa_ IMP=Rx/10	kVA	Dword	R/W
2B3AH - 2B3BH	11066 - 11067	Phase B Inline Apparent Energy	Sum of all Phase B Apparent Energy for all circuits	ESb_ IMP=Rx/10	kVA	Dword	R/W
2B3CH - 2B3DH	11068 - 11069	Phase C Inline Apparent Energy	Sum of all Phase C Apparent Energy for all circuits	ESc_ IMP=Rx/10	kVA	Dword	R/W
2B3EH - 2B3FH	11070 - 11071	Total Inline Apparent Energy	Sum of all Consumed Apparent Energy for all circuits	ES_ IMP=Rx/10	kVA	Dword	R/W
18 Channel Single - Phase and 6 Three - Phase / Single Three Apparent Energy							
2B40H - 2B41H	11072 - 11073	Channel 1 Apparent Energy	Single Phase: Total Apparent Energy in circuit 1 Three Phase/ Single Phase- three wire: Phase A Apparent Energy in circuit 1	ES1_ IMP=Rx/10	kVA	Dword	R/W

Address (H)	Address (D)	Parameter	Description	Relationship	Property	Data Type	Access Property
2B42H - 2B43H	11074 - 11075	Channel 2 Apparent Energy	Single Phase: Total Apparent Energy in circuit 2 Three Phase/ Single Phase- three wire: Phase B Apparent Energy in circuit 1	ES2_ IMP=Rx/10	kVA	Dword	R/W
2B44H - 2B45H	11076 - 11077	Channel 3 Apparent Energy	Single Phase: Total Apparent Energy in circuit 1 Three Phase/ Single Phase- three wire: Phase C Apparent Energy in circuit 1	ES3_ IMP=Rx/10	kVA	Dword	R/W
2B46H - 2B47H	11078 - 11079	Channel 4 Apparent Energy	Single Phase: Total Apparent Energy in circuit 4 Three Phase/ Single Phase- three wire: Phase A Apparent Energy in circuit 1	ES4_ IMP=Rx/10	kVA	Dword	R/W
2B48H - 2B49H	11080 - 11081	Channel 5 Apparent Energy	Single Phase: Total Apparent Energy in circuit 5 Three Phase/ Single Phase- three wire: Phase B Apparent Energy in circuit 1	ES5_ IMP=Rx/10	kVA	Dword	R/W

Address (H)	Address (D)	Parameter	Description	Relationship	Property	Data Type	Access Property
2B4AH - 2B4BH	11082 - 11083	Channel 6 Apparent Energy	Single Phase: Total Apparent Energy in circuit 6 Three Phase/ Single Phase- three wire: Phase C Apparent Energy in circuit 1	ES6_ IMP=Rx/10	kVA	Dword	R/W
2B4CH - 2B4DH	11084 - 11085	Channel 7 Apparent Energy	Single Phase: Total Apparent Energy in circuit 7 Three Phase/ Single Phase- three wire: Phase A Apparent Energy in circuit 1	ES7_ IMP=Rx/10	kVA	Dword	R/W
2B4EH - 2B4FH	11086 - 11087	Channel 8 Apparent Energy	Single Phase: Total Apparent Energy in circuit 8 Three Phase/ Single Phase- three wire: Phase B Apparent Energy in circuit 1	ES8_ IMP=Rx/10	kVA	Dword	R/W
2B50H - 2B51H	11088 - 11089	Channel 9 Apparent Energy	Single Phase: Total Apparent Energy in circuit 9 Three Phase/ Single Phase- three wire: Phase C Apparent Energy in circuit 1	ES9_ IMP=Rx/10	kVA	Dword	R/W

Address (H)	Address (D)	Parameter	Description	Relationship	Property	Data Type	Access Property
2B52H - 2B53H	10090 - 11091	Channel 10 Apparent Energy	Single Phase: Total Apparent Energy in circuit 10 Three Phase/ Single Phase- three wire: Phase A Apparent Energy in circuit 1	ES10_ IMP=Rx/10	kVA	Dword	R/W
2B54H - 2B55H	11092 - 11093	Channel 11 Apparent Energy	Single Phase: Total Apparent Energy in circuit 11 Three Phase/ Single Phase- three wire: Phase B Apparent Energy in circuit 1	ES11_ IMP=Rx/10	kVA	Dword	R/W
2B56H - 2B57H	11094 - 11095	Channel 12 Apparent Energy	Single Phase: Total Apparent Energy in circuit 12 Three Phase/ Single Phase- three wire: Phase C Apparent Energy in circuit 1	ES12_ IMP=Rx/10	kVA	Dword	R/W
2B58H - 2B59H	11096 - 11097	Channel 13 Apparent Energy	Single Phase: Total Apparent Energy in circuit 13 Three Phase/ Single Phase- three wire: Phase A Apparent Energy in circuit 1	ES13_ IMP=Rx/10	kVA	Dword	R/W

Address (H)	Address (D)	Parameter	Description	Relationship	Property	Data Type	Access Property
2B5AH - 2B5BH	11098 - 11099	Channel 14 Apparent Energy	Single Phase: Total Apparent Energy in circuit 14 Three Phase/ Single Phase- three wire: Phase B Apparent Energy in circuit 1	ES14_ IMP=Rx/10	kVA	Dword	R/W
2B5CH - 2B5DH	11100 - 11101	Channel 15 Apparent Energy	Single Phase: Total Apparent Energy in circuit 15 Three Phase/ Single Phase- three wire: Phase C Apparent Energy in circuit 1	ES15_ IMP=Rx/10	kVA	Dword	R/W
2B5EH - 2B5FH	11102 - 11103	Channel 16 Apparent Energy	Single Phase: Total Apparent Energy in circuit 16 Three Phase/ Single Phase- three wire: Phase A Apparent Energy in circuit 1	ES16_ IMP=Rx/10	kVA	Dword	R/W
2B60H - 2B61H	11104 - 11105	Channel 17 Apparent Energy	Single Phase: Total Apparent Energy in circuit 17 Three Phase/ Single Phase- three wire: Phase B Apparent Energy in circuit 1	ES17_ IMP=Rx/10	kVA	Dword	R/W

Address (H)	Address (D)	Parameter	Description	Relationship	Property	Data Type	Access Property
2B62H - 2B63H	11106 - 11107	Channel 18 Apparent Energy	Single Phase: Total Apparent Energy in circuit 18 Three Phase/ Single Phase- three wire: Phase C Apparent Energy in circuit 1	ES18_ IMP=Rx/10	kVA	Dword	R/W
2B64H - 2B65H	11108 - 11109	User Channel 1 Apparent Energy	Total Apparent Energy for the 1st three phase/ single phase three wire circuit	ESs1_ IMP=Rx/10	kVA	Dword	R/W
2B66H - 2B67H	11110 - 11111	User Channel 2 Apparent Energy	Total Apparent Energy for the 2nd three phase/ single phase three wire circuit	ESs2_ IMP=Rx/10	kVA	Dword	R/W
2B68H - 2B69H	11112 - 11113	User Channel 3 Apparent Energy	Total Apparent Energy for the 3rd three phase/ single phase three wire circuit	ESs3_ IMP=Rx/10	kVA	Dword	R/W
2B6AH - 2B6BH	11114 - 11115	User Channel 4 Apparent Energy	Total Apparent Energy for the 4th three phase/ single phase three wire circuit	ESs4_ IMP=Rx/10	kVA	Dword	R/W
2B6CH - 2B6DH	11116 - 11117	User Channel 5 Apparent Energy	Total Apparent Energy for the 5th three phase/ single phase three wire circuit	ESs5_ IMP=Rx/10	kVA	Dword	R/W

Address (H)	Address (D)	Parameter	Description	Relationship	Property	Data Type	Access Property
2B6EH - 2B6FH	11118 - 11119	User Channel 6 Apparent Energy	Total Apparent Energy for the 6th three phase/ single phase three wire circuit	ESs6_ IMP=Rx/10	kVA	Dword	R/W
2B76- 2B77	11120 - 11121	User Channel 7 Apparent Energy	Total Apparent Energy for the 7th two phase three wire circuit	ESs7_ IMP=Rx/10	kVA	Dword	R/W
2B78- 2B79	11122 - 11123	User Channel 8 Apparent Energy	Total Apparent Energy for the 8th two phase three wire circuit	ESs8_ IMP=Rx/10	kVA	Dword	R/W
2B7A- 2B7B	11124 - 11125	User Channel 9 Apparent Energy	Total Apparent Energy for the 9th two phase three wire circuit	ESs9_ IMP=Rx/10	kVA	Dword	R/W

Demand

Address (H)	Address (D)	Parameters	Description	Relationship	Property	Data Type	Access Property
Incoming Demand							
2D00H - 2D01H	11520 - 11521	Total Inline System Power Demand	System Power Demand for all circuits	Rx=Psum_ DMD	kW	Float	R

Address (H)	Address (D)	Parameters	Description	Relationship	Property	Data Type	Access Property
2D02H - 2D03H	11522 - 11523	Total Inline System Power Demand Prediction	System Power Demand Prediction for all circuits	Rx=Psum_ Pred_DMD	kW	Float	R
2D04H - 2D05H	11524 - 11525	Total Inline Peak System Power Demand	Maximum System Power Demand for all circuits	Rx=Psum_ Max_DMD	kW	Float	R
2D06H - 2D08H	11526 - 11527	Inline Peak System Power Demand Time	Time stamp for Maximum System Power Demand				R
2D09H - 2D0AH	11530 - 11531	Total Inline Reactive Power Demand	Reactive Power Demand for all circuits	Rx=Qsum_ DMD	kvar	Float	R
2D0BH - 2D0CH	11532 - 11533	Total Inline Reactive Power Demand Prediction	Reactive Power Demand Prediction for all circuits	Rx=Qsum_ Pred_DMD	kvar	Float	R
2D0DH - 2D0EH	11534 - 11535	Total Inline Peak Reactive Power Demand	Maximum Reactive Power Demand for all circuits	Rx=Qsum_ Max_DMD	kvar	Float	R

Address (H)	Address (D)	Parameters	Description	Relationship	Property	Data Type	Access Property
2D0FH - 2D11H	11536 - 11537	Inline Peak Reactive Power Demand Time	Time stamp for Maximum Reactive Power Demand				R
2D12H - 2D13H	11538 - 11539	Total Inline Apparent Power Demand	Apparent Power Demand for all circuits	Rx=Ssum_ DMD	kVA	Float	R
2D14H - 2D15H	11540 - 11541	Total Inline Apparent Power Demand Prediction	Apparent Power Demand Prediction for all circuits	Rx=Ssum_ Pred_DMD	kVA	Float	R
2D16H - 2D17H	11542 - 11543	Inline Peak Apparent Power Demand	Maximum Apparent Power Demand for all circuits	Rx=Ssum_ Max_DMD	kVA	Float	R
2D18H - 2D1AH	11544 - 11546	Inline Peak Apparent Power Demand Time	Time stamp for Maximum Apparent Power Demand				R
2D1BH - 2D1CH	11547 - 11548	Phase A Inline Current Demand	Phase A Current Demand for all circuits	Rx=Ia_DMD	A	Float	R

Address (H)	Address (D)	Parameters	Description	Relationship	Property	Data Type	Access Property
2D1DH - 2D1EH	11549 - 11550	Phase A Inline Current Demand Prediction	Phase A Current Demand Prediction for all circuits	Rx=Ia_Pred_DMD	A	Float	R
2D1FH - 2D20H	11551 - 11552	Phase A Inline Peak Current Demand	Maximum Phase A Current Demand for all circuits	Rx=Ia_Max_DMD	A	Float	R
2D21H - 2D23H	11553 - 11555	Inline Phase A Peak Current Demand Time	Time stamp for Maximum Phase A Current Demand				R
2D24H - 2D25H	11556 - 11557	Phase A Inline Power Demand	Phase A Power Demand for all circuits	Rx=Pa_DMD	kW	Float	R
2D26H - 2D27H	11558 - 11559	Phase A Inline Power Demand Prediction	Phase A Power Demand Prediction for all circuits	Rx=Pa_Pred_DMD	kW	Float	R
2D28H - 2D29H	11560 - 11561	Phase A Inline Peak Power Demand	Maximum Phase A Peak Power Demand for all circuits	Rx=Pa_Max_DMD	kW	Float	R

Address (H)	Address (D)	Parameters	Description	Relationship	Property	Data Type	Access Property
2D2AH - 2D2CH	11562 - 11564	Inline Phase A Peak Power Demand Time	Time stamp for Maximum Phase A Power Demand				R
2D2DH - 2D2EH	11565 - 11566	Phase A Inline Reactive Power Demand	Phase A Reactive Power Demand for all circuits	Rx=Qa_DMD	kvar	Float	R
2D2FH - 2D30H	11567 - 11568	Phase A Inline Reactive Power Demand Prediction	Phase A Reactive Power Demand Prediction for all circuits	Rx=Qa_Pred_DMD	kvar	Float	R
2D31H - 2D32H	11569 - 11570	Phase A Peak Inline Reactive Power Demand	Maximum Phase A Reactive Power Demand for all circuits	Rx=Qa_Max_DMD	kvar	Float	R
2D33H - 2D35H	11571 - 11573	Inline Phase A Peak Reactive Power Demand Time	Time stamp for Maximum Phase A Reactive Power Demand				R

Address (H)	Address (D)	Parameters	Description	Relationship	Property	Data Type	Access Property
2D36H - R2D37H	11574 - 11575	Phase A Inline Apparent Power Demand	Phase A Apparent Power Demand for all circuits	Rx=Sa_DMD	kVA	Float	R
2D38H - 2D39H	11576 - 11577	Phase A Inline Apparent Power Demand Prediction	Phase A Apparent Power Demand Prediction for all circuits	Rx=Sa_Pred_DMD	kVA	Float	R
2D3AH - 2D3BH	11578 - 11579	Phase A Peak Inline Apparent Power Demand	Maximum Phase A Apparent Demand for all circuits	Rx=Sa_Max_DMD	kVA	Float	R
2D3CH - 2D3EH	11580 - 11582	Inline Phase A Peak Apparent Power Demand Time	Time Stamp for Maximum Phase A Peak Apparent Demand				R
2D3FH - 2D40H	11583 - 11584	Phase B Inline Current Demand	Phase B Current Demand for all circuits	Rx=Ib_DMD	A	Float	R
2D41H - 2D42H	11585 - 11586	Phase B Inline Current Demand Prediction	Phase B Current Demand Prediction for all circuits	Rx=Ib_Pred_DMD	A	Float	R

Address (H)	Address (D)	Parameters	Description	Relationship	Property	Data Type	Access Property
2D43H - 2D44H	11587 - 11588	Phase B Inline Peak Current Demand	Maximum Phase B Current Demand	Rx=Ib_Max_ DMD	A	Float	R
2D45H - 2D47H	11589 - 11591	Inline Phase B Peak Power Demand Time	Time Stamp for Maximum Phase B Current Demand				R
2D48H - 2D49H	11592 - 11593	Phase B Inline Power Demand	Phase B Power Demand for all circuits	Rx=Pb_ DMD	kW	Float	R
2D4AH - 2D4BH	11594 - 11595	Phase B Inline Power Demand Prediction	Phase B Inline Power Demand Prediction for all circuits	Rx=Pb_ Pred_DMD	kW	Float	R
2D4CH - 2D4DH	11596 - 11597	Phase B Inline Peak Power Demand	Maximum Phase B Power Demand for all circuits	Rx=Pb_ Max_DMD	kW	Float	R
2D4EH - 2D50H	11598 - 11600	Inline Phase B Peak Power Demand Time	Time Stamp for Maximum Phase B Power Demand				R

Address (H)	Address (D)	Parameters	Description	Relationship	Property	Data Type	Access Property
2D51H - 2D52H	11601 - 11602	Phase B Inline Reactive Power Demand	Phase B Reactive Power Demand for all circuits	Rx=Qb_DMD	kvar	Float	R
2D53H - 2D54H	11603 - 11604	Phase B Inline Reactive Power Demand Prediction	Phase B Reactive Power Demand Prediction for all circuits	Rx=Qb_Pred_DMD	kvar	Float	R
2D55H - 2D56H	11605 - 11606	Phase B Inline Peak Reactive Power Demand	Maximum Phase B Reactive Power Demand for all circuits	Rx=Qb_Max_DMD	kvar	Float	R
2D57H - 2D59H	11607 - 11609	Inline Phase B Peak Reactive Power Demand Time	Time Stamp for Maximum Phase B Reactive Power Demand				R
2D5AH - 2D5BH	11610 - 11611	Phase B Inline Apparent Power Demand	Phase B Apparent Power Demand for all circuits	Rx=Sb_DMD	kVA	Float	R

Address (H)	Address (D)	Parameters	Description	Relationship	Property	Data Type	Access Property
2D5CH - 2D5DH	11612 - 11613	Phase B Inline Apparent Power Demand Prediction	Phase B Apparent Power Demand Prediction for all circuits	Rx=Sb_Pred_DMD	kVA	Float	R
2D5EH - 2D5FH	11614 - 11615	Phase B Inline Apparent Peak Power Demand	Maximum Phase B Apparent Power Demand for all circuits	Rx=Sb_Max_DMD	kVA	Float	R
2D60H - 2D62H	11616 - 11618	Inline Phase B Apparent Power Demand Time	Time Stamp for Maximum Phase B Apparent Power Demand				R
2D63H - 2D64H	11619 - 11620	Phase C Inline Current Demand	Phase C Current Demand for all circuits	Rx=Ic_DMD	A	Float	R
2D65H - 2D66H	11621 - 11622	Phase C Inline Current Demand Prediction	Phase C Current Demand Prediction for all circuits	Rx=Ic_Pred_DMD	A	Float	R
2D67H - 2D68H	11623 - 11624	Phase C Inline Peak Current Demand	Maximum Phase C Current Demand for all circuits	Rx=Ic_Max_DMD	A	Float	R

Address (H)	Address (D)	Parameters	Description	Relationship	Property	Data Type	Access Property
2D69H - 2D6BH	11625 - 11627	Inline Phase C Peak Current Demand Time	Time Stamp for Maximum Phase C Current Demand				R
2D6CH - 2D6DH	11628 - 11629	Phase C Inline Power Demand	Phase C Power Demand for all circuits	Rx=Pc_DMD	kW	Float	R
2D6EH - 2D6FH	11630 - 11631	Phase C Inline Power Demand Prediction	Phase C Power Demand Prediction for all circuits	Rx=Pc_Pred_DMD	kW	Float	R
2D70H - 2D71H	11632 - 11633	Phase C Inline Peak Power Demand	Maximum Phase C Power Demand for all circuits	Rx=Pc_Max_DMD	kW	Float	R
2D72H - 2D74H	11634 - 11636	Inline Phase C Peak Power Demand Time	Time Stamp for Maximum Phase C Power Demand				R
2D75H - 2D76H	11637 - 11638	Phase C Inline Reactive Power Demand	Phase C Reactive Power Demand for all circuits	Rx=Qc_DMD	kvar	Float	R

Address (H)	Address (D)	Parameters	Description	Relationship	Property	Data Type	Access Property
2D77H - 2D78H	11639 - 11640	Phase C Inline Reactive Power Demand Prediction	Phase C Reactive Power Demand Prediction for all circuits	Rx=Qc_Pred_DMD	kvar	Float	R
2D79H - 2D7AH	11641 - 11642	Phase C Inline Peak Reactive Power Demand	Maximum Phase C Reactive Power Demand for all circuits	Rx=Qc_Max_DMD	kvar	Float	R
2D7BH - 2D7DH	11643 - 11645	Inline Phase C Peak Reactive Power Demand Time	Time Stamp for Maximum Phase C Reactive Power Demand				R
2D7EH - 2D7FH	11646 - 11647	Phase C Inline Apparent Power Demand	Phase C Apparent Power Demand for all circuits	Rx=Sc_DMD	kVA	Float	R
2D80H - 2D81H	11648 - 11649	Phase C Inline Apparent Power Demand Prediction	Phase C Apparent Power Demand Prediction for all circuits	Rx=Sc_Pred_DMD	kVA	Float	R

Address (H)	Address (D)	Parameters	Description	Relationship	Property	Data Type	Access Property
2D82H - 2D83H	11650 - 11651	Phase C Inline Peak Apparent Power Demand	Maximum Phase C Apparent Power Demand for all circuits	Rx=Sc_ Max_DMD	kVA	Float	R
2D84H - 2D86H	11652 - 11654	Inline Phase C Peak Apparent Power Demand Time	Time Stamp for Maximum Phase C Apparent Power Demand				R
2D87H - 2D88H	11655 - 11656	Channel 1 Current Demand	Single Phase: Current Demand for circuit 1 Three Phase/Single Phase- three wire: Phase A Current Demand for circuit 1	Rx=I1_DMD	A	Float	R
2D89H - 2D8AH	11657 - 11658	Channel 1 Current Demand Prediction	Single Phase: Current Demand Prediction for circuit 1 Three Phase/Single Phase-three wire: Phase A Current Demand Prediction for circuit 1	Rx=I1_ Pred_DMD	A	Float	R

Address (H)	Address (D)	Parameters	Description	Relationship	Property	Data Type	Access Property
2D8BH - 2D8CH	11659 - 11660	Channel 1 Peak Current Demand	Single Phase: Maximum Current Demand for circuit 1 Three Phase/Single Phase-three wire: Maximum Phase A Current Demand for circuit 1	Rx=I1_Max_ DMD	A	Float	R
2D8DH - 2D8FH	11661 - 11663	Channel 1 Peak Current Demand Time	Single Phase: Time Stamp for Maximum Current Demand for circuit 1 Three Phase/Single Phase- three wire: Time Stamp for Maximum Current Demand for circuit 1				R
2D90H - 2D91H	11664 - 11665	Channel 1 Power Demand	Single Phase: Power Demand for circuit 1 Three Phase/ Single Phase-three wire: Phase A Power Demand for circuit 1	Rx=P1_ DMD	kW	Float	R
2D92H - 2D93H	11666 - 11667	Channel 1 Power Demand Prediction	Single Phase: Power Demand Prediction for circuit 1 Three Phase/Single Phase- three wire: Phase A Power Demand Prediction for circuit 1	Rx=P1_ Pred_DMD	kW	Float	R

Address (H)	Address (D)	Parameters	Description	Relationship	Property	Data Type	Access Property
2D94H - 2D95H	11668 - 11669	Channel 1 Peak Power Demand	Single Phase: Maximum Power Demand for circuit 1 Three Phase/Single Phase-three wire: Maximum Phase A Power Demand for circuit 1	Rx=P1_Max_DMD	kW	Float	R
2D96H - 2D98H	11670 - 11672	Channel 1 Peak Power Demand Time	Single Phase: Time Stamp for Maximum Power Demand of circuit 1 Three Phase/Single Phase-three wire: Time Stamp for Maximum Phase A Power Demand for circuit 1				R
2D99H - 2D9AH	11673 - 11674	Channel 1 Reactive Power Demand	Single Phase: Reactive Power Demand of circuit 1 Three Phase/Single Phase-three wire: Phase A Reactive Power Demand for circuit 1	Rx=Q1_DMD	kvar	Float	R

Address (H)	Address (D)	Parameters	Description	Relationship	Property	Data Type	Access Property
2D9BH - 2D9CH	11675 - 11676	Channel 1 Reactive Power Demand Prediction	Single Phase: Reactive Power Demand Prediction for circuit 1 Three Phase/Single Phase- three wire: Phase A Reactive Power Demand Prediction for circuit 1	Rx=Q1_ Pred_DMD	kvar	Float	R
2D9DH - 2D9EH	11677 - 11678	Channel 1 Peak Reactive Power Demand	Single Phase: Maximum Reactive Power Demand for circuit 1 Three Phase/Single Phase-three wire: Maximum Phase A Reactive Power Demand for circuit 1	Rx=Q1_ Max_DMD	kvar	Float	R
2D9FH - 2DA1H	11679 - 11681	Channel 1 Peak Reactive Power Demand Time	Single Phase: Time Stamp for Maximum Reactive Power Demand for circuit 1 Three Phase/Single Phase-three wire: Time Stamp for Phase A Reactive Power Demand for circuit 1				R

Address (H)	Address (D)	Parameters	Description	Relationship	Property	Data Type	Access Property
2DA2H - 2DA3H	11682 - 11683	Channel 1 Apparent Power Demand	Single Phase: Apparent Power Demand for circuit 1 Three Phase/Single Phase-three wire: Phase A Apparent Power Demand for circuit 1	Rx=S1_ DMD	kVA	Float	R
2DA4H - 2DA5H	11684 - 11685	Channel 1 Apparent Power Demand Prediction	Single Phase: Apparent Power Demand Prediction for circuit 1 Three Phase/Single Phase-three wire: Phase A Apparent Power Demand Prediction for circuit 1	Rx=S1_ Pred_DMD	kVA	Float	R
2DA6H - 2DA7H	11686 - 11687	Channel 1 Peak Apparent Power Demand	Single Phase: Maximum Apparent Power Demand for circuit 1 Three Phase/Single Phase-three wire: Maximum Phase A Apparent Power Demand for circuit 1	Rx=S1_ Max_DMD	kVA	Float	R

Address (H)	Address (D)	Parameters	Description	Relationship	Property	Data Type	Access Property
2DA8H - 2DAAH	11688 - 11690	Channel 1 Peak Apparent Power Demand Time	Single Phase: Time Stamp for Maximum Apparent Power Demand in circuit 1 Three Phase/Single Phase-three wire: Time Stamp for Maximum Phase A Apparent Power Demand for circuit 1				R
2DABH - 2DACH	11691 - 11692	Channel 2 Current Demand	Single Phase: Current Demand for circuit 2 Three Phase/Single Phase-three wire: Phase B Current Demand for circuit 2	Rx=I2_DMD	A	Float	R
2DADH - 2DAEH	11693 - 11694	Channel 2 Current Demand Prediction	Single Phase: Current Demand Prediction for circuit 2 Three Phase/Single Phase-three wire: Phase B Current Demand Prediction for circuit 2	Rx=I2_Pred_DMD	A	Float	R
2DAFH - 2DB0H	11695 - 11696	Channel 2 Peak Current Demand	Single Phase: Maximum Current Demand for circuit 2 Three Phase/Single Phase-three wire: Maximum Phase B Current Demand for circuit 2	Rx=I2_Max_DMD	A	Float	R

Address (H)	Address (D)	Parameters	Description	Relationship	Property	Data Type	Access Property
2DB1H - 2DB3H	11697 - 11699	Channel 2 Peak Current Demand Time	Single Phase: Time Stamp for Maximum Current Demand for circuit 2 Three Phase/Single Phase-three wire: Time Stamp for Maximum Phase B Current Demand for circuit 2				R
2DB4H - 2DB5H	11700 - 11701	Channel 2 Power Demand	Single Phase: Power Demand for circuit 2 Three Phase/Single Phase-three wire: Phase B Power Demand for circuit 2	Rx=P2_DMD	kW	Float	R
2DB6H - 2DB7H	11702 - 11703	Channel 2 Power Demand Prediction	Single Phase: Power Demand Prediction for circuit 2 Three Phase/Single Phase-three wire: Phase B Power Demand Prediction for circuit 2	Rx=P2_Pred_DMD	kW	Float	R
2DB8H - 2DB9H	11704 - 11705	Channel 2 Peak Power Demand	Single Phase: Maximum Power Demand for circuit 2 Three Phase/Single Phase-three wire: Maximum Phase B Power Demand for circuit 2	Rx=P2_Max_DMD	kW	Float	R

Address (H)	Address (D)	Parameters	Description	Relationship	Property	Data Type	Access Property
2DBAH - 2DBCH	11706 - 11708	Channel 2 Peak Power Demand Time	Single Phase: Time Stamp for Maximum Power Demand for circuit 2 Three Phase/Single Phase-three wire: Time Stamp for Maximum Phase B Power Demand for circuit 2				R
2DBDH - 2DBEH	11709 - 11710	Channel 2 Reactive Power Demand	Single Phase: Reactive Power Demand for circuit 2 Three Phase/Single Phase-three wire: Phase B Reactive Power Demand for circuit 2	Rx=Q2_DMD	kvar	Float	R
2DBFH - 2DCOH	11711 - 11712	Channel 2 Reactive Power Demand Prediction	Single Phase: Reactive Power Demand Prediction for circuit 2 Three Phase/Single Phase-three wire: Phase B Reactive Power Demand Prediction for circuit 2	Rx=Q2_Pred_DMD	kvar	Float	R

Address (H)	Address (D)	Parameters	Description	Relationship	Property	Data Type	Access Property
2DC1H - 2DC2H	11713 - 11714	Channel 2 Peak Reactive Power Demand	Single Phase: Maximum Reactive Power Demand for circuit 2 Three Phase/Single Phase-three wire: Maximum Phase B Reactive Power Demand for circuit 2	Rx=Q2_Max_DMD	kvar	Float	R
2DC3H - 2DC5H	11715 - 11717	Channel 2 Peak Reactive Power Demand Time	Single Phase: Time Stamp for Maximum Reactive Power Demand for circuit 2 Three Phase/Single Phase-three wire: Time Stamp for Maximum Phase B Reactive Power Demand for circuit 2				R
2DC6H - 2DC7H	11718 - 11719	Channel 2 Apparent Power Demand	Single Phase: Apparent Power Demand for circuit 2 Three Phase/Single Phase-three wire: Phase B Apparent Power Demand for circuit 2	Rx=S2_DMD	kVA	Float	R

Address (H)	Address (D)	Parameters	Description	Relationship	Property	Data Type	Access Property
2DC8H - 2DC9H	11720 - 11721	Channel 2 Apparent Power Demand Prediction	Single Phase: Apparent Power Demand Prediction for circuit 2 Three Phase/Single Phase- three wire: Phase B Apparent Power Demand Prediction for circuit 2	Rx=S2_ Pred_DMD	kVA	Float	R
2DCAH - 2DCBH	11722 - 11723	Channel 2 Peak Apparent Power Demand	Single Phase: Maximum Apparent Power Demand for circuit 2 Three Phase/Single Phase-three wire: Maximum Phase B Apparent Power Demand for circuit 2	Rx=S2_ Max_DMD	kVA	Float	R
2DCCH - 2DCEH	11724 - 11726	Channel 2 Peak Apparent Power Demand Time	Single Phase: Time Stamp for Maximum Apparent Power Demand for circuit 2 Three Phase/Single Phase-three wire: Time Stamp for Maximum Phase B Apparent Power Demand for circuit 2				R

Address (H)	Address (D)	Parameters	Description	Relationship	Property	Data Type	Access Property
2DCFH - 2DD0H	11727 - 11728	Channel 3 Current Demand	Single Phase: Current Demand for circuit 3 Three Phase/Single Phase-three wire: Phase C Current Demand for circuit 3	Rx=I3_DMD	A	Float	R
2DD1H - 2DD2H	11729 - 11730	Channel 3 Current Demand Prediction	Single Phase: Current Demand Prediction for circuit 3 Three Phase/Single Phase-three wire: Phase C Current Demand Prediction for circuit 3	Rx=I3_Pred_DMD	A	Float	R
2DD3H - 2DD4H	11731 - 11732	Channel 3 Peak Current Demand	Single Phase: Maximum Current Demand for circuit 3 Three Phase/Single Phase-three wire: Maximum Phase C Current Demand for circuit 3	Rx=I3_Max_DMD	A	Float	R
2DD5H - 2DD7H	11733 - 11735	Channel 3 Peak Current Demand Time	Single Phase: Time Stamp for Maximum Current Demand for circuit 3 Three Phase/Single Phase-three wire: Time Stamp for Maximum Phase C Current Demand for circuit 3				R

Address (H)	Address (D)	Parameters	Description	Relationship	Property	Data Type	Access Property
2DD8H - 2DD9H	11736 - 11737	Channel 3 Power Demand	Single Phase: Power Demand for circuit 3 Three Phase/ Single Phase-three wire: Phase C Power Demand for circuit 3	Rx=P3_ DMD	kW	Float	R
2DDAH - 2DDBH	11738 - 11739	Channel 3 Power Demand Prediction	Single Phase: Power Demand Prediction for circuit 3 Three Phase/ Single Phase-three wire: Phase C Power Demand Prediction for circuit 3	Rx=P3_ Pred_DMD	kW	Float	R
2DDCH - 2DDDH	11740 - 11741	Channel 3 Peak Power Demand	Single Phase: Maximum Power Demand for circuit 3 Three Phase/ Single Phase-three wire: Maximum Phase C Power Demand for circuit 3	Rx=P3_ Max_DMD	kW	Float	R
2DDEH - 2DE0H	11742 - 11744	Channel 3 Peak Power Demand Time	Single Phase: Time Stamp for Maximum Power Demand for circuit 3 Three Phase/ Single Phase-three wire: Time Stamp for Maximum Phase C Power Demand for circuit 3				R

Address (H)	Address (D)	Parameters	Description	Relationship	Property	Data Type	Access Property
2DE1H - 2DE2H	11745 - 11746	Channel 3 Reactive Power Demand	Single Phase: Reactive Power Demand for circuit 3 Three Phase/Single Phase-three wire: Phase C Reactive Power Demand for circuit 3	Rx=Q3_ DMD	kvar	Float	R
2DE3H - 2DE4H	11747 - 11748	Channel 3 Reactive Power Demand Prediction	Single Phase: Reactive Power Demand Prediction for circuit 3 Three Phase/Single Phase-three wire: Phase C Reactive Power Demand Prediction for circuit 3	Rx=Q3_ Pred_DMD	kvar	Float	R
2DE5H - 2DE6H	11749 - 11750	Channel 3 Peak Reactive Power Demand	Single Phase: Maximum Reactive Power Demand for circuit 3 Three Phase/Single Phase-three wire: Maximum Phase C Reactive Power Demand for circuit 3	Rx=Q3_ Max_DMD	kvar	Float	R

Address (H)	Address (D)	Parameters	Description	Relationship	Property	Data Type	Access Property
2DE7H - 2DE9H	11751 - 11753	Channel 3 Peak Reactive Power Demand Time	Single Phase: Time Stamp for Maximum Reactive Power Demand for circuit 3 Three Phase/Single Phase-three wire: Time Stamp for Maximum Phase C Reactive Power Demand for circuit 3				R
2DEAH - 2DEBH	11754 - 11755	Channel 3 Apparent Power Demand	Single Phase: Apparent Power Demand for circuit 3 Three Phase/Single Phase-three wire: Phase C Apparent Power Demand for circuit 3	Rx=S3_DMD	kVA	Float	R
2DECH - 2DEDH	11756 - 11757	Channel 3 Apparent Power Demand Prediction	Single Phase: Apparent Power Demand Prediction for circuit 3 Three Phase/Single Phase-three wire: Phase C Apparent Power Demand Prediction for circuit 3	Rx=S3_Pred_DMD	kVA	Float	R

Address (H)	Address (D)	Parameters	Description	Relationship	Property	Data Type	Access Property
2DEEH - 2DEFH	11758 - 11759	Channel 3 Peak Apparent Power Demand	Single Phase: Maximum Apparent Power Demand for circuit 3 Three Phase/Single Phase-three wire: Maximum Phase C Apparent Power Demand for circuit 3	Rx=S3_Max_DMD	kVA	Float	R
2DF0H - 2DF2H	11760 - 11762	Channel 3 Peak Apparent Power Demand Time	Single Phase: Time Stamp for Maximum Apparent Power Demand for circuit 3 Three Phase/Single Phase-three wire: Time Stamp for Maximum Phase C Apparent Power Demand for circuit 3				R
2DF3H - 2DF4H	11763 - 11764	Channel 4 Current Demand	Single Phase: Current Demand for circuit 4 Three Phase/Single Phase-three wire: Phase A Current Demand for circuit 2	Rx=I4_DMD	A	Float	R

Address (H)	Address (D)	Parameters	Description	Relationship	Property	Data Type	Access Property
2DF5H - 2DF6H	11765 - 11766	Channel 4 Current Demand Prediction	Single Phase: Current Demand Prediction for circuit 4 Three Phase/Single Phase-three wire: Phase Current Demand Prediction for circuit 2	Rx=I4_Pred_DMD	A	Float	R
2DF7H - 2DF8H	11767 - 11768	Channel 4 Peak Current Demand	Single Phase: Maximum Current Demand for circuit 4 Three Phase/Single Phase-three wire: Maximum Phase A Current Demand for circuit 2	Rx=I4_Max_DMD	A	Float	R
2DF9H - 2DFBH	11769 - 11771	Channel 4 Peak Current Demand Time	Single Phase: Time Stamp for Maximum Current Demand for circuit 4 Three Phase/Single Phase-three wire: Time Stamp for Maximum Phase A Current Demand for circuit 2				R
2DFCH - 2DFDH	11772 - 11773	Channel 4 Power Demand	Single Phase: Power Demand for circuit 4 Three Phase/Single Phase-three wire: Phase A Power Demand for circuit 2	Rx=P4_DMD	kW	Float	R

Address (H)	Address (D)	Parameters	Description	Relationship	Property	Data Type	Access Property
2DFEH - 2DFFH	11774 - 11775	Channel 4 Power Demand Prediction	Single Phase: Power Demand Prediction for circuit 4 Three Phase/Single Phase-three wire: Phase A Power Demand Prediction for circuit 2	Rx=P4_Pred_DMD	kW	Float	R
2E00H - 2E01H	11776 - 11777	Channel 4 Peak Power Demand	Single Phase: Maximum Power Demand for circuit 4 Three Phase/Single Phase-three wire: Maximum Phase A Power Demand for circuit 2	Rx=P4_Max_DMD	kW	Float	R
2E02H - 2E04H	11778 - 11780	Channel 4 Peak Power Demand Time	Single Phase: Time Stamp for Maximum Power Demand for circuit 4 Three Phase/Single Phase-three wire: Time Stamp for Maximum Phase A Power Demand for circuit 2				R
2E05H - 2E06H	11781 - 11782	Channel 4 Reactive Power Demand	Single Phase: Reactive Power Demand for circuit 4 Three Phase/Single Phase-three wire: Phase A Reactive Power Demand for circuit 2	Rx=Q4_DMD	kvar	Float	R

Address (H)	Address (D)	Parameters	Description	Relationship	Property	Data Type	Access Property
2E07H - 2E08H	11783 - 11784	Channel 4 Reactive Power Demand Prediction	Single Phase: Reactive Power Demand Prediction for circuit 4 Three Phase/Single Phase- three wire: Phase A Reactive Power Demand Prediction for circuit 2	Rx=Q4_ Pred_DMD	kvar	Float	R
2E09H - 2E0AH	11785 - 11786	Channel 4 Peak Reactive Power Demand	Single Phase: Maximum Reactive Power Demand for circuit 4 Three Phase/Single Phase-three wire: Maximum Phase A Reactive Power Demand for circuit 2	Rx=Q4_ Max_DMD	kvar	Float	R
2E0BH - 2E0DH	11787 - 11789	Channel 4 Peak Reactive Power Demand Time	Single Phase: Time Stamp for Maximum Reactive Power Demand for circuit 4 Three Phase/Single Phase-three wire: Time Stamp for Maximum Phase A Reactive Power Demand for circuit 2				R

Address (H)	Address (D)	Parameters	Description	Relationship	Property	Data Type	Access Property
2E0EH - 2E0FH	11790 - 11791	Channel 4 Apparent Power Demand	Single Phase: Apparent Power Demand for circuit 4Three Phase/Single Phase-three wire: Phase A Apparent Power Demand for circuit 2	Rx=S4_ DMD	kVA	Float	R
2E10H - 2E11H	11792 - 11793	Channel 4 Apparent Power Demand Prediction	Single Phase: Apparent Power Demand Prediction for circuit 4Three Phase/Single Phase- three wire: Phase A Apparent Power Demand Prediction for circuit 2	Rx=S4_ Pred_DMD	kVA	Float	R
2E12H - 2E13H	11794 - 11795	Channel 4 Peak Apparent Power Demand	Single Phase: Maximum Apparent Power Demand for circuit 4Three Phase/Single Phase-three wire: Maximum Phase A Apparent Power Demand for circuit 2	Rx=S4_ Max_DMD	kVA	Float	R

Address (H)	Address (D)	Parameters	Description	Relationship	Property	Data Type	Access Property
2E14H - 2E16H	11796 - 11798	Channel 4 Peak Apparent Power Demand Time	Single Phase: Time Stamp for Maximum Apparent Power Demand for circuit 4 Three Phase/Single Phase-three wire: Time Stamp for Maximum Phase A Apparent Power Demand for circuit 2				R
2E17H - 2E18H	11799 - 11800	Channel 5 Current Demand	Single Phase: Current Demand for circuit 5 Three Phase/Single Phase-three wire: Phase B Current Demand for circuit 2	Rx=I5_DMD	A	Float	R
2E19H - 2E1AH	11801 - 11802	Channel 5 Current Demand Prediction	Single Phase: Current Demand Prediction for circuit 5 Three Phase/Single Phase-three wire: Phase B Current Demand Prediction for circuit 2	Rx=I5_Pred_DMD	A	Float	R
2E1BH - 2E1CH	11803 - 11804	Channel 5 Peak Current Demand	Single Phase: Maximum Current Demand for circuit 5 Three Phase/Single Phase-three wire: Maximum Phase B Current Demand for circuit 2	Rx=I5_Max_DMD	A	Float	R

Address (H)	Address (D)	Parameters	Description	Relationship	Property	Data Type	Access Property
2E1DH - 2E1FH	11805 - 11807	Channel 5 Peak Current Demand Time	Single Phase: Time Stamp for Maximum Current Demand for circuit 5 Three Phase/Single Phase-three wire: Time Stamp for Maximum Phase B Current Demand for circuit 2				R
2E20H - 2E21H	11808 - 11809	Channel 5 Power Demand	Single Phase: Power Demand for circuit 5 Three Phase/Single Phase-three wire: Phase B Power Demand for circuit 2	Rx=P5_DMD	kW	Float	R
2E22H - 2E23H	11810 - 11811	Channel 5 Power Demand Prediction	Single Phase: Power Demand Prediction for circuit 5 Three Phase/Single Phase-three wire: Phase B Power Demand Prediction for circuit 2	Rx=P5_Pred_DMD	kW	Float	R
2E24H - 2E25H	11812 - 11813	Channel 5 Peak Power Demand	Single Phase: Maximum Power Demand for circuit 5 Three Phase/Single Phase-three wire: Maximum Phase B Power Demand for circuit 2	Rx=P5_Max_DMD	kW	Float	R

Address (H)	Address (D)	Parameters	Description	Relationship	Property	Data Type	Access Property
2E26H - 2E28H	11814 - 11816	Channel 5 Peak Power Demand Time	Single Phase: Time Stamp for Maximum Power Demand for circuit 5 Three Phase/Single Phase-three wire: Time Stamp for Maximum Phase B Power Demand for circuit 2				R
2E29H - 2E2AH	11817 - 11818	Channel 5 Reactive Power Demand	Single Phase: Reactive Power Demand for circuit 5 Three Phase/Single Phase-three wire: Phase B Reactive Power Demand for circuit 2	Rx=Q5_DMD	kvar	Float	R
2E2BH - 2E2CH	11819 - 11820	Channel 5 Reactive Power Demand Prediction	Single Phase: Reactive Power Demand Prediction for circuit 5 Three Phase/Single Phase-three wire: Phase B Reactive Power Demand Prediction for circuit 2	Rx=Q5_Pred_DMD	kvar	Float	R

Address (H)	Address (D)	Parameters	Description	Relationship	Property	Data Type	Access Property
2E2DH - 2E2EH	11821 - 11822	Channel 5 Peak Reactive Power Demand	Single Phase: Maximum Reactive Power Demand for circuit 5 Three Phase/Single Phase-three wire: Maximum Phase B reactive Power Demand for circuit 2	Rx=Q5_Max_DMD	kvar	Float	R
2E2FH - 2E31H	11823 - 11825	Channel 5 Peak Reactive Power Demand Time	Single Phase: Time Stamp for Maximum Reactive Power Demand for circuit 5 Three Phase/Single Phase-three wire: Time Stamp for Maximum Phase B Reactive Power Demand for circuit 2				R
2E32H - 2E33H	11826 - 11827	Channel 5 Apparent Power Demand	Single Phase: Apparent Power Demand for circuit 5 Three Phase/Single Phase-three wire: Phase B Apparent Power Demand for circuit 2	Rx=S5_DMD	kVA	Float	R

Address (H)	Address (D)	Parameters	Description	Relationship	Property	Data Type	Access Property
2E34H - 2E35H	11828 - 11829	Channel 5 Apparent Power Demand Prediction	Single Phase: Apparent Power Demand Prediction for circuit 5 Three Phase/Single Phase- three wire: Phase B Apparent Power Demand Prediction for circuit 2	Rx=S5_ Pred_DMD	kVA	Float	R
2E36H - 2E37H	11830 - 11831	Channel 5 Peak Apparent Power Demand	Single Phase: Maximum Apparent Power Demand for circuit 5 Three Phase/Single Phase-three wire: Maximum Phase B Apparent Power Demand for circuit 2	Rx=S5_ Max_DMD	kVA	Float	R
2E38H - 2E3AH	11832 - 11834	Channel 5 Peak Apparent Power Demand Time	Single Phase: Time Stamp for Maximum Apparent Power Demand for circuit 5 Three Phase/Single Phase-three wire: Time Stamp for Maximum Phase B Apparent Power Demand for circuit 2				R

Address (H)	Address (D)	Parameters	Description	Relationship	Property	Data Type	Access Property
2E3BH - 2E3CH	11835 - 11836	Channel 6 Current Demand	Single Phase: Current Demand for circuit 6 Three Phase/Single Phase-three wire: Phase C Current Demand for circuit 2	Rx=I6_DMD	A	Float	R
2E3DH - 2E3EH	11837 - 11838	Channel 6 Current Demand Prediction	Single Phase: Current Demand Prediction for circuit 6 Three Phase/Single Phase-three wire: Phase C Current Demand Prediction for circuit 2	Rx=I6_Pred_DMD	A	Float	R
2E3FH - 2E40H	11839 - 11840	Channel 6 Peak Current Demand	Single Phase: Maximum Current Demand for circuit 6 Three Phase/Single Phase-three wire: Maximum Phase C Current Demand for circuit 2	Rx=I6_Max_DMD	A	Float	R
2E41H - 2E43H	11841 - 11843	Channel 6 Peak Current Demand Time	Single Phase: Time Stamp for Maximum Current Demand for circuit 6 Three Phase/Single Phase-three wire: Time Stamp for Maximum Phase C Current Demand for circuit 2				R

Address (H)	Address (D)	Parameters	Description	Relationship	Property	Data Type	Access Property
2E44H - 2E45H	11844 - 11845	Channel 6 Power Demand	Single Phase: Power Demand for circuit 6 Three Phase/Single Phase-three wire: Phase C Power Demand for circuit 2	Rx=P6_DMD	kW	Float	R
2E46H - 2E47H	11846 - 11847	Channel 6 Power Demand Prediction	Single Phase: Power Demand Prediction for circuit 6 Three Phase/Single Phase-three wire: Phase C Power Demand Prediction for circuit 2	Rx=P6_Pred_DMD	kW	Float	R
2E48H - 2E49H	11848 - 11849	Channel 6 Peak Power Demand	Single Phase: Maximum Power Demand for circuit 6 Three Phase/Single Phase-three wire: Maximum Phase C Power Demand for circuit 2	Rx=P6_Max_DMD	kW	Float	R
2E4AH - 2E4CH	11850 - 11852	Channel 6 Peak Power Demand Time	Single Phase: Time Stamp for Maximum Power Demand for circuit 6 Three Phase/Single Phase-three wire: Time Stamp for Maximum Phase C Power Demand for circuit 2				R

Address (H)	Address (D)	Parameters	Description	Relationship	Property	Data Type	Access Property
2E4DH - 2E4EH	11853 - 11854	Channel 6 Reactive Power Demand	Single Phase: Reactive Power Demand for circuit 6 Three Phase/Single Phase-three wire: Phase C Reactive Power Demand for circuit 2	Rx=Q6_ DMD	kvar	Float	R
2E4FH - 2E50H	11855 - 11856	Channel 6 Reactive Power Demand Prediction	Single Phase: Reactive Power Demand Prediction for circuit 6 Three Phase/Single Phase- three wire: Phase C Reactive Power Demand Prediction for circuit 2	Rx=Q6_ Pred_DMD	kvar	Float	R
2E51H - 2E52H	11857 - 11858	Channel 6 Peak Reactive Power Demand	Single Phase: Maximum Reactive Power Demand for circuit 6 Three Phase/Single Phase-three wire: Maximum Phase C Reactive Power Demand for circuit 2	Rx=Q6_ Max_DMD	kvar	Float	R

Address (H)	Address (D)	Parameters	Description	Relationship	Property	Data Type	Access Property
2E53H - 2E55H	11859 - 11861	Channel 6 Peak Reactive Power Demand Time	Single Phase: Time Stamp for Maximum Reactive Power Demand for circuit 6 Three Phase/Single Phase-three wire: Time Stamp for Maximum Phase C Reactive Power Demand for circuit 2				R
2E56H - 2E57H	11862 - 11863	Channel 6 Apparent Power Demand	Single Phase: Apparent Power Demand for circuit 6 Three Phase/Single Phase-three wire: Phase C Apparent Power Demand for circuit 2	Rx=S6_DMD	kVA	Float	R
2E58H - 2E59H	11864 - 11865	Channel 6 Apparent Power Demand Prediction	Single Phase: Apparent Power Demand Prediction for circuit 6 Three Phase/Single Phase-three wire: Phase C Apparent Power Demand Prediction for circuit 2	Rx=S6_Pred_DMD	kVA	Float	R

Address (H)	Address (D)	Parameters	Description	Relationship	Property	Data Type	Access Property
2E5AH - 2E5BH	11866 - 11867	Channel 6 Peak Apparent Power Demand	Single Phase: Maximum Apparent Power Demand for circuit 6 Three Phase/Single Phase-three wire: Maximum Phase C Apparent Power Demand for circuit 2	Rx=S6_Max_DMD	kVA	Float	R
2E5CH - 2E5EH	11868 - 11870	Channel 6 Peak Apparent Power Demand Time	Single Phase: Time Stamp for Maximum Apparent Power Demand for circuit 6 Three Phase/Single Phase-three wire: Time Stamp for Maximum Phase C Apparent Power Demand for circuit 2				R
2E5FH - 2E60H	11871 - 11872	Channel 7 Current Demand	Single Phase: Current Demand for circuit 7 Three Phase/Single Phase-three wire: Phase A Current Demand for circuit 3	Rx=I7_DMD	A	Float	R

Address (H)	Address (D)	Parameters	Description	Relationship	Property	Data Type	Access Property
2E61H - 2E62H	11873 - 11874	Channel 7 Current Demand Prediction	Single Phase: Current Demand Prediction for circuit 7 Three Phase/Single Phase-three wire: Phase A Current Demand Prediction for circuit 3	Rx=I7_Pred_DMD	A	Float	R
2E63H - 2E64H	11875 - 11876	Channel 7 Peak Current Demand	Single Phase: Maximum Current Demand for circuit 7 Three Phase/Single Phase-three wire: Maximum Phase A Current Demand for circuit 3	Rx=I7_Max_DMD	A	Float	R
2E65H - 2E67H	11877 - 11879	Channel 7 Peak Current Demand Time	Single Phase: Time Stamp for Maximum Current Demand for circuit 7 Three Phase/Single Phase-three wire: Time Stamp for Maximum Phase A Current Demand for circuit 3				R
2E68H - 2E69H	11880 - 11881	Channel 7 Power Demand	Single Phase: Power Demand for circuit 7 Three Phase/Single Phase-three wire: Phase A Power Demand for circuit 3	Rx=P7_DMD	kW	Float	R

Address (H)	Address (D)	Parameters	Description	Relationship	Property	Data Type	Access Property
2E6AH - 2E6BH	11882 - 11883	Channel 7 Power Demand Prediction	Single Phase: Power Demand Prediction for circuit 7 Three Phase/Single Phase-three wire: Phase A Power Demand Prediction for circuit 3	Rx=P7_Pred_DMD	kW	Float	R
2E6CH - 2E6DH	11884 - 11885	Channel 7 Peak Power Demand	Single Phase: Maximum Power Demand for circuit 7 Three Phase/Single Phase-three wire: Maximum Phase A Power Demand for circuit 3	Rx=P7_Max_DMD	kW	Float	R
2E6EH - 2E70H	11886 - 11888	Channel 7 Peak Power Demand Time	Single Phase: Time Stamp for Maximum Power Demand for circuit 7 Three Phase/Single Phase-three wire: Time Stamp for Maximum Phase A Power Demand for circuit 3				R
2E71H - 2E72H	11889 - 11890	Channel 7 Reactive Power Demand	Single Phase: Reactive Power Demand for circuit 7 Three Phase/Single Phase-three wire: Phase A Reactive Power Demand for circuit 3	Rx=Q7_DMD	kvar	Float	R

Address (H)	Address (D)	Parameters	Description	Relationship	Property	Data Type	Access Property
2E73H - 2E74H	11891 - 11892	Channel 7 Reactive Power Demand Prediction	Single Phase: Reactive Power Demand Prediction for circuit 7 Three Phase/Single Phase- three wire: Phase A Reactive Power Demand Prediction for circuit 3	Rx=Q7_ Pred_DMD	kvar	Float	R
2E75H - 2E76H	11893 - 11894	Channel 7 Peak Reactive Power Demand	Single Phase: Maximum Reactive Power Demand for circuit 7 Three Phase/Single Phase-three wire: Maximum Phase A Reactive Power Demand for circuit 3	Rx=Q7_ Max_DMD	kvar	Float	R
2E77H - 2E79H	11895 - 11897	Channel 7 Peak Reactive Power Demand Time	Single Phase: Time Stamp for Maximum Reactive Power Demand for circuit 7 Three Phase/Single Phase-three wire: Time Stamp for Maximum Phase A Reactive Power Demand for circuit 3				R

Address (H)	Address (D)	Parameters	Description	Relationship	Property	Data Type	Access Property
2E7AH - 2E7BH	11898 - 11899	Channel 7 Apparent Power Demand	Single Phase: Apparent Power Demand for circuit 7 Three Phase/Single Phase-three wire: Phase A Apparent Power Demand for circuit 3	Rx=S7_ DMD	kVA	Float	R
2E7CH - 2E7DH	11900 - 11901	Channel 7 Apparent Power Demand Prediction	Single Phase: Apparent Power Demand Prediction for circuit 7 Three Phase/Single Phase-three wire: Phase A Apparent Power Demand Prediction for circuit 3	Rx=S7_ Pred_DMD	kVA	Float	R
2E7EH - 2E7FH	11902 - 11903	Channel 7 Peak Apparent Power Demand	Single Phase: Maximum Apparent Power Demand for circuit 7 Three Phase/Single Phase-three wire: Maximum Phase A Apparent Power Demand for circuit 3	Rx=S7_ Max_DMD	kVA	Float	R

Address (H)	Address (D)	Parameters	Description	Relationship	Property	Data Type	Access Property
2E80H - 2E82H	11904 - 11906	Channel 7 Peak Apparent Power Demand Time	Single Phase: Time Stamp for Maximum Apparent Power Demand for circuit 7 Three Phase/Single Phase-three wire: Time Stamp for Maximum Phase A Apparent Power Demand for circuit 3				R
2E83H - 2E84H	11907 - 11908	Channel 8 Current Demand	Single Phase: Current Demand for circuit 8 Three Phase/Single Phase-three wire: Phase B Current Demand for circuit 3	Rx=I8_DMD	A	Float	R
2E85H - 2E86H	11909 - 11910	Channel 8 Current Demand Prediction	Single Phase: Current Demand Prediction for circuit 8 Three Phase/Single Phase-three wire: Phase B Current Demand Prediction for circuit 3	Rx=I8_Pred_DMD	A	Float	R
2E87H - 2E88H	11911 - 11912	Channel 8 Peak Current Demand	Single Phase: Maximum Current Demand for circuit 8 Three Phase/Single Phase-three wire: Maximum Phase B Current Demand for circuit 3	Rx=I8_Max_DMD	A	Float	R

Address (H)	Address (D)	Parameters	Description	Relationship	Property	Data Type	Access Property
2E89H - 2E8BH	11913 - 11915	Channel 8 Peak Current Demand Time	Single Phase: Time Stamp for Maximum Current Demand for circuit 8 Three Phase/Single Phase-three wire: Time Stamp for Maximum Phase B Current Demand for circuit 3				R
2E8CH - 2E8DH	11916 - 11917	Channel 8 Power Demand	Single Phase: Power Demand for circuit 8 Three Phase/Single Phase-three wire: Phase B Power Demand for circuit 3	Rx=P8_DMD	kW	Float	R
2E8EH - 2E8FH	11918 - 11919	Channel 8 Power Demand Prediction	Single Phase: Power Demand Prediction for circuit 8 Three Phase/Single Phase-three wire: Phase B Power Demand Prediction for circuit 3	Rx=P8_Pred_DMD	kW	Float	R
2E90H - 2E91H	11920 - 11921	Channel 8 Peak Power Demand	Single Phase: Maximum Power Demand for circuit 8 Three Phase/Single Phase-three wire: Maximum Phase B Power Demand for circuit 3	Rx=P8_Max_DMD	kW	Float	R

Address (H)	Address (D)	Parameters	Description	Relationship	Property	Data Type	Access Property
2E92H - 2E94H	11922 - 11924	Channel 8 Peak Power Demand Time	Single Phase: Time Stamp for Maximum Power Demand for circuit 8 Three Phase/Single Phase-three wire: Time Stamp for Maximum Phase B Power Demand for circuit 3				R
2E95H - 2E96H	11925 - 11926	Channel 8 Reactive Power Demand	Single Phase: Reactive Power Demand for circuit 8 Three Phase/Single Phase-three wire: Phase B Reactive Power Demand for circuit 3	Rx=Q8_DMD	kvar	Float	R
2E97H - 2E98H	11927 - 11928	Channel 8 Reactive Power Demand Prediction	Single Phase: Reactive Power Demand Prediction for circuit 8 Three Phase/Single Phase-three wire: Phase B Reactive Power Demand Prediction for circuit 3	Rx=Q8_Pred_DMD	kvar	Float	R

Address (H)	Address (D)	Parameters	Description	Relationship	Property	Data Type	Access Property
2E99H - 2E9AH	11929 - 11930	Channel 8 Peak Reactive Power Demand	Single Phase: Maximum Reactive Power Demand for circuit 8 Three Phase/Single Phase-three wire: Maximum Phase B Reactive Power Demand for circuit 3	Rx=Q8_Max_DMD	kvar	Float	R
2E9BH - 2E9DH	11931 - 11933	Channel 8 Peak Reactive Power Demand Time	Single Phase: Time Stamp for Maximum Reactive Power Demand for circuit 8 Three Phase/Single Phase-three wire: Time Stamp for Maximum Phase B Reactive Power Demand for circuit 3				R
2E9EH - 2E9FH	11934 - 11935	Channel 8 Apparent Power Demand	Single Phase: Apparent Power Demand for circuit 8 Three Phase/Single Phase-three wire: Phase B Apparent Power Demand for circuit 3	Rx=S8_Max_DMD	kVA	Float	R

Address (H)	Address (D)	Parameters	Description	Relationship	Property	Data Type	Access Property
2EA0H - 2EA1H	11936 - 11937	Channel 8 Apparent Power Demand Prediction	Single Phase: Apparent Power Demand Prediction for circuit 8 Three Phase/Single Phase- three wire: Phase B Apparent Power Demand Prediction for circuit 3	Rx=S8_ Pred_DMD	kVA	Float	R
2EA2H - 2EA3H	11938 - 11939	Channel 8 Peak Apparent Power Demand	Single Phase: Maximum Apparent Power Demand for circuit 8 Three Phase/Single Phase-three wire: Maximum Phase B Apparent Power Demand for circuit 3	Rx=S8_ Max_DMD	kVA	Float	R
2EA4H - 2EA6H	11940 - 11942	Channel 8 Peak Apparent Power Demand Time	Single Phase: Time Stamp for Maximum Apparent Power Demand for circuit 8 Three Phase/Single Phase-three wire: Time Stamp for Maximum Phase B Apparent Power Demand for circuit 3				R

Address (H)	Address (D)	Parameters	Description	Relationship	Property	Data Type	Access Property
2EA7H - 2EA8H	11943 - 11944	Channel 9 Current Demand	Single Phase: Current Demand for circuit 9 Three Phase/Single Phase-three wire: Phase C Current Demand for circuit 3	Rx=I9_DMD	A	Float	R
2EA9H - 2EAAH	11945 - 11946	Channel 9 Current Demand Prediction	Single Phase: Current Demand Prediction for circuit 9 Three Phase/Single Phase-three wire: Phase C Current Demand Prediction for circuit 3	Rx=I9_Pred_DM	A	Float	R
2EABH - 2EACH	11947 - 11948	Channel 9 Peak Current Demand	Single Phase: Maximum Current Demand for circuit 9 Three Phase/Single Phase-three wire: Maximum Phase C Current Demand for circuit 3	Rx=I9_Max_DMD	A	Float	R
2EADH - 2EAFH	11949 - 11951	Channel 9 Peak Current Demand Time	Single Phase: Time Stamp for Maximum Current Demand for circuit 9 Three Phase/Single Phase-three wire: Time Stamp for Maximum Phase C Current Demand for circuit 3				R

Address (H)	Address (D)	Parameters	Description	Relationship	Property	Data Type	Access Property
2EB0H - 2EB1H	11952 - 11953	Channel 9 Power Demand	Single Phase: Power Demand for circuit 9 Three Phase/Single Phase-three wire: Phase C Power Demand for circuit 3	Rx=P9_DMD	kW	Float	R
2EB2H - 2EB3H	11954 - 11955	Channel 9 Power Demand Prediction	Single Phase: Power Demand Prediction for circuit 9 Three Phase/Single Phase-three wire: Phase C Power Demand Prediction for circuit 3	Rx=P9_Pred_DMD	kW	Float	R
2EB4H - 2EB5H	11956 - 11957	Channel 9 Peak Power Demand	Single Phase: Maximum Power Demand for circuit 9 Three Phase/Single Phase-three wire: Maximum Phase C Power Demand for circuit 3	Rx=P9_Max_DMD	kW	Float	R
2EB6H - 2EB8H	11958 - 11960	Channel 9 Peak Power Demand Time	Single Phase: Time Stamp for Maximum Power Demand for circuit 9 Three Phase/Single Phase-three wire: Time Stamp for Maximum Phase C Power Demand for circuit 3				R

Address (H)	Address (D)	Parameters	Description	Relationship	Property	Data Type	Access Property
2EB9H - 2EBAH	11961 - 11962	Channel 9 Reactive Power Demand	Single Phase: Reactive Power Demand for circuit 9 Three Phase/Single Phase-three wire: Phase C Reactive Power Demand for circuit 3	Rx=Q9_ DMD	kvar	Float	R
2EBBH - 2EBCH	11963 - 11964	Channel 9 Reactive Power Demand Prediction	Single Phase: Reactive Power Demand Prediction for circuit 9 Three Phase/Single Phase-three wire: Phase C Reactive Power Demand Prediction for circuit 3	Rx=Q9_ Pred_DMD	kvar	Float	R
2EBDH - 2EBEH	11965 - 11966	Channel 9 Peak Reactive Power Demand	Single Phase: Maximum Reactive Power Demand for circuit 9 Three Phase/Single Phase-three wire: Maximum Phase C Reactive Power Demand for circuit 3	Rx=Q9_ Max_DMD	kvar	Float	R

Address (H)	Address (D)	Parameters	Description	Relationship	Property	Data Type	Access Property
2EBFH - 2EC1H	11967 - 11969	Channel 9 Peak Reactive Power Demand Time	Single Phase: Time Stamp for Maximum Reactive Power Demand for circuit 9 Three Phase/Single Phase-three wire: Time Stamp for Maximum Phase C Reactive Power Demand for circuit 3				R
2EC2H - 2EC3H	11970 - 11971	Channel 9 Apparent Power Demand	Single Phase: Apparent Power Demand for circuit 9 Three Phase/Single Phase-three wire: Phase C Apparent Power Demand for circuit 3	Rx=S9_DMD	kVA	Float	R
2EC4H - 2EC5H	11972 - 11973	Channel 9 Apparent Power Demand Prediction	Single Phase: Apparent Power Demand Prediction for circuit 9 Three Phase/Single Phase-three wire: Phase C Apparent Power Demand Prediction for circuit 3	Rx=S9_Pred_DMD	kVA	Float	R

Address (H)	Address (D)	Parameters	Description	Relationship	Property	Data Type	Access Property
2EC6H - 2EC7H	11974 - 11975	Channel 9 Peak Apparent Power Demand	Single Phase: Maximum Apparent Power Demand for circuit 9 Three Phase/Single Phase-three wire: Maximum Phase C Apparent Power Demand for circuit 3	Rx=S9_Max_DMD	kVA	Float	R
2EC8H - 2ECAH	11976 - 11978	Channel 9 Peak Apparent Power Demand Time	Single Phase: Time Stamp for Maximum Apparent Power Demand for circuit 9 Three Phase/Single Phase-three wire: Time Stamp for Maximum Phase C Apparent Power Demand for circuit 3				R
2ECBH - 2ECCH	11979 - 11980	Channel 10 Current Demand	Single Phase: Current Demand for circuit 10 Three Phase/Single Phase-three wire: Phase A Current Demand for circuit 4	Rx=I10_DMD	A	Float	R

Address (H)	Address (D)	Parameters	Description	Relationship	Property	Data Type	Access Property
2ECDH - 2ECEH	11981 - 11982	Channel 10 Current Demand Prediction	Single Phase: Current Demand Prediction for circuit 10Three Phase/ Single Phase- three wire: Phase A Current Demand Prediction for circuit 4	Rx=I10_ Pred_DM	A	Float	R
2ECFH - 2ED0H	11983 - 11984	Channel 10 Peak Current Demand	Single Phase: Maximum Current Demand for circuit 10Three Phase/ Single Phase-three wire: Maximum Phase A Current Demand for circuit 4	Rx=I10_ Max_DMD	A	Float	R
2ED1H - 2ED3H	11985 - 11987	Channel 10 Peak Current Demand Time	Single Phase: Time Stamp for Maximum Current Demand for circuit 10Three Phase/Single Phase- three wire: Time Stamp for Maximum Phase A Current Demand for circuit 4				R
2ED4H - 2ED5H	11988 - 11989	Channel 10 Power Demand	Single Phase: Power Demand for circuit 10Three Phase/ Single Phase-three wire: Phase A Power Demand for circuit 4	Rx=P10_ DMD	kW	Float	R

Address (H)	Address (D)	Parameters	Description	Relationship	Property	Data Type	Access Property
2ED6H - 2ED7H	11990 - 11991	Channel 10 Power Demand Prediction	Single Phase: Power Demand Prediction for circuit 10 Three Phase/Single Phase-three wire: Phase A Power Demand Prediction for circuit 4	Rx=P10_Pred_DMD	kW	Float	R
2ED8H - 2ED9H	11992 - 11993	Channel 10 Peak Power Demand	Single Phase: Maximum Power Demand for circuit 10 Three Phase/Single Phase-three wire: Maximum Phase A Power Demand for circuit 4	Rx=P10_Max_DMD	kW	Float	R
2EDAH - 2EDCH	11994 - 11996	Channel 10 Peak Power Demand Time	Single Phase: Time Stamp for Maximum Power Demand for circuit 10 Three Phase/Single Phase-three wire: Time Stamp for Maximum Phase A Power Demand for circuit 4				R
2EDDH - 2EDEH	11997 - 11998	Channel 10 Reactive Power Demand	Single Phase: Reactive Power Demand for circuit 10 Three Phase/Single Phase-three wire: Phase A Reactive Power Demand for circuit 4	Rx=Q10_DMD	kvar	Float	R

Address (H)	Address (D)	Parameters	Description	Relationship	Property	Data Type	Access Property
2EDFH - 2EE0H	11999 - 12000	Channel 10 Reactive Power Demand Prediction	Single Phase: Reactive Power Demand Prediction for circuit 10 Three Phase/Single Phase- three wire: Phase A Reactive Power Demand Prediction for circuit 4	Rx=Q10_ Pred_DMD	kvar	Float	R
2EE1H - 2EE2H	12001 - 12002	Channel 10 Peak Reactive Power Demand	Single Phase: Maximum Reactive Power Demand for circuit 10 Three Phase/Single Phase-three wire: Maximum Phase A Reactive Power Demand for circuit 4	Rx=Q10_ Max_DMD	kvar	Float	R
2EE3H - 2EE5H	12003 - 12005	Channel 10 Peak Reactive Power Demand Time	Single Phase: Time Stamp for Maximum Reactive Power Demand for circuit 10 Three Phase/ Single Phase-three wire: Time Stamp for Maximum Phase A Reactive Power Demand for circuit 4				R

Address (H)	Address (D)	Parameters	Description	Relationship	Property	Data Type	Access Property
2EE6H - 2EE7H	12006 - 12007	Channel 10 Apparent Power Demand	Single Phase: Apparent Power Demand for circuit 10 Three Phase/Single Phase-three wire: Phase A Apparent Power Demand for circuit 4	Rx=S10_DMD	kVA	Float	R
2EE8H - 2EE9H	12008 - 12009	Channel 10 Apparent Power Demand Prediction	Single Phase: Apparent Power Demand Prediction for circuit 10 Three Phase/Single Phase-three wire: Phase A Apparent Power Demand Prediction for circuit 4	Rx=S10_Pred_DMD	kVA	Float	R
2EEAH - 2EEBH	12010 - 12011	Channel 10 Peak Apparent Power Demand	Single Phase: Maximum Apparent Power Demand for circuit 10 Three Phase/Single Phase-three wire: Maximum Phase A Apparent Power Demand for circuit 4	Rx=S10_Max_DMD	kVA	Float	R

Address (H)	Address (D)	Parameters	Description	Relationship	Property	Data Type	Access Property
2EECH - 2EEEH	12012 - 12014	Channel 10 Peak Apparent Power Demand Time	Single Phase: Time Stamp for Maximum Apparent Power Demand for circuit 10 Three Phase/Single Phase-three wire: Time Stamp for Maximum Phase A Apparent Power Demand for circuit 4				R
2EEFH - 2EF0H	12015 - 12016	Channel 11 Current Demand	Single Phase: Current Demand for circuit 11 Three Phase/Single Phase-three wire: Phase B Current Demand for circuit 4	Rx=I11_DMD	A	Float	R
2EF1H - 2EF2H	12017 - 12018	Channel 11 Current Demand Prediction	Single Phase: Current Demand Prediction for circuit 11 Three Phase/Single Phase-three wire: Phase B Current Demand Prediction for circuit 4	Rx=I11_Pred_DM	A	Float	R

Address (H)	Address (D)	Parameters	Description	Relationship	Property	Data Type	Access Property
2EF3H - 2EF4H	12019 - 12020	Channel 11 Peak Current Demand	Single Phase: Maximum Current Demand for circuit 11 Three Phase/Single Phase-three wire: Maximum Phase B Current Demand for circuit 4	Rx=I11_Max_DMD	A	Float	R
2EF5H - 2EF7H	12021 - 12023	Channel 11 Peak Current Demand Time	Single Phase: Time Stamp for Maximum Current Demand for circuit 11 Three Phase/Single Phase-three wire: Time Stamp for Maximum Phase B Current Demand for circuit 4				R
2EF8H - 2EF9H	12024 - 12025	Channel 11 Power Demand	Single Phase: Power Demand for circuit 11 Three Phase/Single Phase-three wire: Phase B Power Demand for circuit 4	Rx=P11_DMD	kW	Float	R
2EFAH - 2EFBH	12026 - 12027	Channel 11 Power Demand Prediction	Single Phase: Power Demand Prediction for circuit 11 Three Phase/Single Phase-three wire: Phase B Power Demand Prediction for circuit 4	Rx=P11_Pred_DMD	kW	Float	R

Address (H)	Address (D)	Parameters	Description	Relationship	Property	Data Type	Access Property
2EFCH - 2EFDH	12028 - 12029	Channel 11 Peak Power Demand	Single Phase: Maximum Power Demand for circuit 11 Three Phase/Single Phase-three wire: Maximum Phase B Power Demand for circuit 4	Rx=P11_Max_DMD	kW	Float	R
2EFEH - 2F00	12030 - 12032	Channel 11 Peak Power Demand Time	Single Phase: Time Stamp for Maximum Power Demand for circuit 11 Three Phase/Single Phase-three wire: Time Stamp for Maximum Phase B Power Demand for circuit 4				R
2F01H - 2F02H	12033 - 12034	Channel 11 Reactive Power Demand	Single Phase: Reactive Power Demand for circuit 11 Three Phase/Single Phase-three wire: Phase B Reactive Power Demand for circuit 4	Rx=Q11_DMD	kvar	Float	R

Address (H)	Address (D)	Parameters	Description	Relationship	Property	Data Type	Access Property
2F03H - 2F04H	12035 - 12036	Channel 11 Reactive Power Demand Prediction	Single Phase: Reactive Power Demand Prediction for circuit 11 Three Phase/Single Phase-three wire: Phase B Reactive Power Demand Prediction for circuit 4	Rx=Q11_Pred_DMD	kvar	Float	R
2F05H - 2F06H	12037 - 12038	Channel 11 Peak Reactive Power Demand	Single Phase: Maximum Reactive Power Demand for circuit 11 Three Phase/Single Phase-three wire: Maximum Phase B Reactive Power Demand for circuit 4	Rx=Q11_Max_DMD	kvar	Float	R
2F07H - 2F09H	12039 - 12041	Channel 11 Peak Reactive Power Demand Time	Single Phase: Time Stamp for Maximum Reactive Power Demand for circuit 11 Three Phase/Single Phase-three wire: Time Stamp for Maximum Phase B Reactive Power Demand for circuit 4				R

Address (H)	Address (D)	Parameters	Description	Relationship	Property	Data Type	Access Property
2F0AH - 2F0BH	12042 - 12043	Channel 11 Apparent Power Demand	Single Phase: Apparent Power Demand for circuit 11 Three Phase/ Single Phase- three wire: Phase B Apparent Power Demand for circuit 4	Rx=S11_ DMD	kVA	Float	R
2F0CH - 2F0DH	12044 - 12045	Channel 11 Apparent Power Demand Prediction	Single Phase: Apparent Power Demand Prediction for circuit 11 Three Phase/ Single Phase- three wire: Phase B Apparent Power Demand Prediction for circuit 4	Rx=S11_ Pred_DMD	kVA	Float	R
2F0EH - 2F0FH	12046 - 12047	Channel 11 Peak Apparent Power Demand	Single Phase: Maximum Apparent Power Demand for circuit 11 Three Phase/ Single Phase-three wire: Maximum Phase B Apparent Power Demand for circuit 4	Rx=S11_ Max_DMD	kVA	Float	R

Address (H)	Address (D)	Parameters	Description	Relationship	Property	Data Type	Access Property
2F10H - 2F12H	12048 - 12050	Channel 11 Peak Apparent Power Demand Time	Single Phase: Time Stamp for Maximum Apparent Power Demand for circuit 11 Three Phase/Single Phase-three wire: Time Stamp for Maximum Phase B Apparent Power Demand for circuit 4				R
2F13H - 2F14H	12051 - 12052	Channel 12 Current Demand	Single Phase: Current Demand for circuit 12 Three Phase/Single Phase-three wire: Phase C Current Demand for circuit 4	Rx=I12_DMD	A	Float	R
2F15H - 2F16H	12053 - 12054	Channel 12 Current Demand Prediction	Single Phase: Current Demand Prediction for circuit 12 Three Phase/Single Phase-three wire: Phase C Current Demand Prediction for circuit 4	Rx=I12_Pred_DM	A	Float	R

Address (H)	Address (D)	Parameters	Description	Relationship	Property	Data Type	Access Property
2F17H - 2F18H	12055 - 12056	Channel 12 Peak Current Demand	Single Phase: Maximum Current Demand for circuit 12 Three Phase/Single Phase-three wire: Maximum Phase C Current Demand for circuit 4	Rx=I12_Max_DMD	A	Float	R
2F19H - 2F1BH	12057 - 12059	Channel 12 Peak Current Demand Time	Single Phase: Time Stamp for Maximum Current Demand for circuit 12 Three Phase/Single Phase-three wire: Time Stamp for Maximum Phase C Current Demand for circuit 4				R
2F1CH - 2F1DH	12060 - 12061	Channel 12 Power Demand	Single Phase: Power Demand for circuit 12 Three Phase/Single Phase-three wire: Phase C Power Demand for circuit 4	Rx=P12_DMD	kW	Float	R
2F1EH - 2F1FH	12062 - 12063	Channel 12 Power Demand Prediction	Single Phase: Power Demand Prediction for circuit 12 Three Phase/Single Phase-three wire: Phase C Power Demand Prediction for circuit 4	Rx=P12_Pred_DMD	kW	Float	R

Address (H)	Address (D)	Parameters	Description	Relationship	Property	Data Type	Access Property
2F20H - 2F21H	12064 - 12065	Channel 12 Peak Power Demand	Single Phase: Maximum Power Demand for circuit 12 Three Phase/Single Phase-three wire: Maximum Phase C Power Demand for circuit 4	Rx=P12_Max_DMD	kW	Float	R
2F22H - 2F24H	12066 - 12068	Channel 12 Peak Power Demand Time	Single Phase: Time Stamp for Maximum Power Demand for circuit 12 Three Phase/Single Phase-three wire: Time Stamp for Maximum Phase C Power Demand for circuit 4				R
2F25H - 2F26H	12069 - 12070	Channel 12 Reactive Power Demand	Single Phase: Reactive Power Demand for circuit 12 Three Phase/Single Phase-three wire: Phase C Reactive Power Demand for circuit 4	Rx=Q12_DMD	kvar	Float	R

Address (H)	Address (D)	Parameters	Description	Relationship	Property	Data Type	Access Property
2F27H - 2F28H	12071 - 12072	Channel 12 Reactive Power Demand Prediction	Single Phase: Reactive Power Demand Prediction for circuit 12 Three Phase/Single Phase-three wire: Phase C Reactive Power Demand Prediction for circuit 4	Rx=Q12_Pred_DMD	kvar	Float	R
2F29H - 2F2AH	12073 - 12074	Channel 12 Peak Reactive Power Demand	Single Phase: Maximum Reactive Power Demand for circuit 12 Three Phase/Single Phase-three wire: Maximum Phase C Reactive Power Demand for circuit 4	Rx=Q12_Max_DMD	kvar	Float	R
2F2BH - 2F2DH	12075 - 12077	Channel 12 Peak Reactive Power Demand Time	Single Phase: Time Stamp for Maximum Reactive Power Demand for circuit 12 Three Phase/Single Phase-three wire: Time Stamp for Maximum Phase C Reactive Power Demand for circuit 4				R

Address (H)	Address (D)	Parameters	Description	Relationship	Property	Data Type	Access Property
2F2EH - 2F2FH	12078 - 12079	Channel 12 Apparent Power Demand	Single Phase: Apparent Power Demand for circuit 12 Three Phase/Single Phase-three wire: Phase C Apparent Power Demand for circuit 4	Rx=S12_DMD	kVA	Float	R
2F30H - 2F31H	12080 - 12081	Channel 12 Apparent Power Demand Prediction	Single Phase: Apparent Power Demand Prediction for circuit 12 Three Phase/Single Phase-three wire: Phase C Apparent Power Demand Prediction for circuit 4	Rx=S12_Pred_DMD	kVA	Float	R
2F32H - 2F33H	12082 - 12083	Channel 12 Peak Apparent Power Demand	Single Phase: Maximum Apparent Power Demand for circuit 12 Three Phase/Single Phase-three wire: Maximum Phase C Apparent Power Demand for circuit 4	Rx=S12_Max_DMD	kVA	Float	R

Address (H)	Address (D)	Parameters	Description	Relationship	Property	Data Type	Access Property
2F34H - 2F36H	12084 - 12086	Channel 12 Peak Apparent Power Demand Time	Single Phase: Time Stamp for Maximum Apparent Power Demand for circuit 12 Three Phase/Single Phase-three wire: Time Stamp for Maximum Phase C Apparent Power Demand for circuit 4				R
2F37H - 2F38H	12087 - 12088	Channel 13 Current Demand	Single Phase: Current Demand for circuit 13 Three Phase/Single Phase-three wire: Phase A Current Demand for circuit 5	Rx=I13_ DMD	A	Float	R
2F39H - 2F3AH	12089 - 12090	Channel 13 Current Demand Prediction	Single Phase: Current Demand Prediction for circuit 13 Three Phase/Single Phase-three wire: Phase A Current Demand Prediction for circuit 5	Rx=I13_ Pred_DM	A	Float	R

Address (H)	Address (D)	Parameters	Description	Relationship	Property	Data Type	Access Property
2F3BH - 2F3CH	12091 - 12092	Channel 13 Peak Current Demand	Single Phase: Maximum Current Demand for circuit 13 Three Phase/Single Phase-three wire: Maximum Phase A Current Demand for circuit 5	Rx=I13_Max_DMD	A	Float	R
2F3DH - 2F3FH	12093 - 12095	Channel 13 Peak Current Demand Time	Single Phase: Time Stamp for Maximum Current Demand for circuit 13 Three Phase/Single Phase-three wire: Time Stamp for Maximum Phase A Current Demand for circuit 5				R
2F40H - 2F41H	12096 - 12097	Channel 13 Power Demand	Single Phase: Power Demand for circuit 13 Three Phase/Single Phase-three wire: Phase A Power Demand for circuit 5	Rx=P13_DMD	kW	Float	R
2F42H - 2F43H	12098 - 12099	Channel 13 Power Demand Prediction	Single Phase: Power Demand Prediction for circuit 13 Three Phase/Single Phase-three wire: Phase A Power Demand Prediction for circuit 5	Rx=P13_Pred_DMD	kW	Float	R

Address (H)	Address (D)	Parameters	Description	Relationship	Property	Data Type	Access Property
2F44H - 2F45H	12100 - 12101	Channel 13 Peak Power Demand	Single Phase: Maximum Power Demand for circuit 13 Three Phase/Single Phase-three wire: Maximum Phase A Power Demand for circuit 5	Rx=P13_Max_DMD	kW	Float	R
2F46H - 2F48H	12102 - 12104	Channel 13 Peak Power Demand Time	Single Phase: Time Stamp for Maximum Power Demand for circuit 13 Three Phase/Single Phase-three wire: Time Stamp for Maximum Phase A Power Demand for circuit 5				R
2F49H - 2F4AH	12105 - 12106	Channel 13 Reactive Power Demand	Single Phase: Reactive Power Demand for circuit 13 Three Phase/Single Phase-three wire: Phase A Reactive Power Demand for circuit 5	Rx=Q13_DMD	kvar	Float	R

Address (H)	Address (D)	Parameters	Description	Relationship	Property	Data Type	Access Property
2F4BH - 2F4CH	12107 - 10108	Channel 13 Reactive Power Demand Prediction	Single Phase: Reactive Power Demand Prediction for circuit 13 Three Phase/Single Phase-three wire: Phase A Reactive Power Demand Prediction for circuit 5	Rx=Q13_Pred_DMD	kvar	Float	R
2F4DH - 2F4EH	12109 - 12110	Channel 13 Peak Reactive Power Demand	Single Phase: Maximum Reactive Power Demand for circuit 13 Three Phase/Single Phase-three wire: Maximum Phase A Reactive Power Demand for circuit 5	Rx=Q13_Max_DMD	kvar	Float	R
2F4FH - 2F51H	12111 - 12113	Channel 13 Peak Reactive Power Demand Time	Single Phase: Time Stamp for Maximum Reactive Power Demand for circuit 13 Three Phase/Single Phase-three wire: Time Stamp for Maximum Phase A Reactive Power Demand for circuit 5				R

Address (H)	Address (D)	Parameters	Description	Relationship	Property	Data Type	Access Property
2F52H - 2F53H	12114 - 12115	Channel 13 Apparent Power Demand	Single Phase: Apparent Power Demand for circuit 13Three Phase/ Single Phase- three wire: Phase A Apparent Power Demand for circuit 5	Rx=S13_ DMD	kVA	Float	R
2F54H - 2F55H	12116 - 12117	Channel 13 Apparent Power Demand Prediction	Single Phase: Apparent Power Demand Prediction for circuit 13Three Phase/Single Phase- three wire: Phase A Apparent Power Demand Prediction for circuit 5	Rx=S13_ Pred_DMD	kVA	Float	R
2F56H - 2F57H	12118 - 12119	Channel 13 Peak Apparent Power Demand	Single Phase: Maximum Apparent Power Demand for circuit 13Three Phase/Single Phase-three wire: Maximum Phase A Apparent Power Demand for circuit 5	Rx=S13_ Max_DMD	kVA	Float	R

Address (H)	Address (D)	Parameters	Description	Relationship	Property	Data Type	Access Property
2F58H - 2F5AH	12120 - 12122	Channel 13 Peak Apparent Power Demand Time	Single Phase: Time Stamp for Maximum Apparent Power Demand for circuit 13 Three Phase/Single Phase-three wire: Time Stamp for Maximum Phase A Apparent Power Demand for circuit 5				R
2F5BH - 2F5CH	12123 - 12124	Channel 14 Current Demand	Single Phase: Current Demand for circuit 14 Three Phase/Single Phase-three wire: Phase B Current Demand for circuit 5	Rx=I14_DMD	A	Float	R
2F5DH - 2F5EH	12125 - 12126	Channel 14 Current Demand Prediction	Single Phase: Current Demand Prediction for circuit 14 Three Phase/Single Phase-three wire: Phase B Current Demand Prediction for circuit 5	Rx=I14_Pred_DM	A	Float	R

Address (H)	Address (D)	Parameters	Description	Relationship	Property	Data Type	Access Property
2F5FH - 2F60H	12127 - 12128	Channel 14 Peak Current Demand	Single Phase: Maximum Current Demand for circuit 14 Three Phase/Single Phase-three wire: Maximum Phase B Current Demand for circuit 5	Rx=I14_Max_DMD	A	Float	R
2F61H - 2F63H	12129 - 12131	Channel 14 Peak Current Demand Time	Single Phase: Time Stamp for Maximum Current Demand for circuit 14 Three Phase/Single Phase-three wire: Time Stamp for Maximum Phase B Current Demand for circuit 5				R
2F64H - 2F65H	12132 - 12133	Channel 14 Power Demand	Single Phase: Power Demand for circuit 14 Three Phase/Single Phase-three wire: Phase B Power Demand for circuit 5	Rx=P14_DMD	kW	Float	R
2F66H - 2F67H	12134 - 12135	Channel 14 Power Demand Prediction	Single Phase: Power Demand Prediction for circuit 14 Three Phase/Single Phase-three wire: Phase B Power Demand Prediction for circuit 5	Rx=P14_Pred_DMD	kW	Float	R

Address (H)	Address (D)	Parameters	Description	Relationship	Property	Data Type	Access Property
2F68H - 2F69H	12136 - 12137	Channel 14 Peak Power Demand	Single Phase: Maximum Power Demand for circuit 14 Three Phase/Single Phase-three wire: Maximum Phase B Power Demand for circuit 5	Rx=P14_Max_DMD	kW	Float	R
2F6AH - 2F6CH	12138 - 12140	Channel 14 Peak Power Demand Time	Single Phase: Time Stamp for Maximum Power Demand for circuit 14 Three Phase/Single Phase-three wire: Time Stamp for Maximum Phase B Power Demand for circuit 5				R
2F6DH - 2F6EH	12141 - 12142	Channel 14 Reactive Power Demand	Single Phase: Reactive Power Demand for circuit 14 Three Phase/Single Phase-three wire: Phase B Reactive Power Demand for circuit 5	Rx=Q14_DMD	kvar	Float	R

Address (H)	Address (D)	Parameters	Description	Relationship	Property	Data Type	Access Property
2F6FH - 2F70H	12143 - 12144	Channel 14 Reactive Power Demand Prediction	Single Phase: Reactive Power Demand Prediction for circuit 14 Three Phase/Single Phase-three wire: Phase B Reactive Power Demand Prediction for circuit 5	Rx=Q14_Pred_DMD	kvar	Float	R
2F71H - 2F72H	12145 - 12146	Channel 14 Peak Reactive Power Demand	Single Phase: Maximum Reactive Power Demand for circuit 14 Three Phase/Single Phase-three wire: Maximum Phase B Reactive Power Demand for circuit 5	Rx=Q14_Max_DMD	kvar	Float	R
2F73H - 2F75H	12147 - 12149	Channel 14 Peak Reactive Power Demand Time	Single Phase: Time Stamp for Maximum Reactive Power Demand for circuit 14 Three Phase/Single Phase-three wire: Time Stamp for Maximum Phase B Reactive Power Demand for circuit 5				R

Address (H)	Address (D)	Parameters	Description	Relationship	Property	Data Type	Access Property
2F76H - 2F77H	12150 - 12151	Channel 14 Apparent Power Demand	Single Phase: Apparent Power Demand for circuit 14 Three Phase/Single Phase-three wire: Phase B Apparent Power Demand for circuit 5	Rx=S14_DMD	kVA	Float	R
2F78H - 2F79H	12152 - 12153	Channel 14 Apparent Power Demand Prediction	Single Phase: Apparent Power Demand Prediction for circuit 14 Three Phase/Single Phase-three wire: Phase B Apparent Power Demand Prediction for circuit 5	Rx=S14_Pred_DMD	kVA	Float	R
2F7AH - 2F7BH	12154 - 12155	Channel 14 Peak Apparent Power Demand	Single Phase: Maximum Apparent Power Demand for circuit 14 Three Phase/Single Phase-three wire: Maximum Phase B Apparent Power Demand for circuit 5	Rx=S14_Max_DMD	kVA	Float	R

Address (H)	Address (D)	Parameters	Description	Relationship	Property	Data Type	Access Property
2F7CH - 2F7EH	12156 - 12158	Channel 14 Peak Apparent Power Demand Time	Single Phase: Time Stamp for Maximum Apparent Power Demand for circuit 14 Three Phase/Single Phase-three wire: Time Stamp for Maximum Phase B Apparent Power Demand for circuit 5				R
2F7FH - 2F80H	12159 - 12160	Channel 15 Current Demand	Single Phase: Current Demand for circuit 15 Three Phase/Single Phase-three wire: Phase C Current Demand for circuit 5	Rx=I15_ DMD	A	Float	R
2F81G - 2F82H	12161 - 12162	Channel 15 Current Demand Prediction	Single Phase: Current Demand Prediction for circuit 15 Three Phase/Single Phase-three wire: Phase C Current Demand Prediction for circuit 5	Rx=I15_ Pred_DM	A	Float	R

Address (H)	Address (D)	Parameters	Description	Relationship	Property	Data Type	Access Property
2F83H - 2F84H	12163 - 12164	Channel 15 Peak Current Demand	Single Phase: Maximum Current Demand for circuit 15 Three Phase/Single Phase-three wire: Maximum Phase C Current Demand for circuit 5	Rx=I15_Max_DMD	A	Float	R
2F85H - 2F87H	12165 - 12167	Channel 15 Peak Current Demand Time	Single Phase: Time Stamp for Maximum Current Demand for circuit 15 Three Phase/Single Phase-three wire: Time Stamp for Maximum Phase C Current Demand for circuit 5				R
2F88H - 2F89H	12168 - 12169	Channel 15 Power Demand	Single Phase: Power Demand for circuit 15 Three Phase/Single Phase-three wire: Phase C Power Demand for circuit 5	Rx=P15_DMD	kW	Float	R
2F8AH - 2F8BH	12170 - 12171	Channel 15 Power Demand Prediction	Single Phase: Power Demand Prediction for circuit 15 Three Phase/Single Phase-three wire: Phase C Power Demand Prediction for circuit 5	Rx=P15_Pred_DMD	kW	Float	R

Address (H)	Address (D)	Parameters	Description	Relationship	Property	Data Type	Access Property
2F8CH - 2F8DH	12172 - 12173	Channel 15 Peak Power Demand	Single Phase: Maximum Power Demand for circuit 15 Three Phase/Single Phase-three wire: Maximum Phase C Power Demand for circuit 5	Rx=P15_Max_DMD	kW	Float	R
2F8EH - 2F90H	12174 - 12176	Channel 15 Peak Power Demand Time	Single Phase: Time Stamp for Maximum Power Demand for circuit 15 Three Phase/Single Phase-three wire: Time Stamp for Maximum Phase C Power Demand for circuit 5				R
2F91H - 2F92H	12177 - 12178	Channel 15 Reactive Power Demand	Single Phase: Reactive Power Demand for circuit 15 Three Phase/Single Phase-three wire: Phase C Reactive Power Demand for circuit 5	Rx=Q15_DMD	kvar	Float	R

Address (H)	Address (D)	Parameters	Description	Relationship	Property	Data Type	Access Property
2F93H - 2F94H	12179 - 12180	Channel 15 Reactive Power Demand Prediction	Single Phase: Reactive Power Demand Prediction for circuit 15 Three Phase/Single Phase-three wire: Phase C Reactive Power Demand Prediction for circuit 5	Rx=Q15_Pred_DMD	kvar	Float	R
2F95H - 2F96H	12181 - 12182	Channel 15 Peak Reactive Power Demand	Single Phase: Maximum Reactive Power Demand for circuit 15 Three Phase/Single Phase-three wire: Maximum Phase C Reactive Power Demand for circuit 5	Rx=Q15_Max_DMD	kvar	Float	R
2F97H - 2F99H	12183 - 12185	Channel 15 Peak Reactive Power Demand Time	Single Phase: Time Stamp for Maximum Reactive Power Demand for circuit 15 Three Phase/Single Phase-three wire: Time Stamp for Maximum Phase C Reactive Power Demand for circuit 5				R

Address (H)	Address (D)	Parameters	Description	Relationship	Property	Data Type	Access Property
2F9AH - 2F9BH	12186 - 12187	Channel 15 Apparent Power Demand	Single Phase: Apparent Power Demand for circuit 15 Three Phase/ Single Phase- three wire: Phase C Apparent Power Demand for circuit 5	Rx=S15_ DMD	kVA	Float	R
2F9CH - 2F9DH	12188 - 12189	Channel 15 Apparent Power Demand Prediction	Single Phase: Apparent Power Demand Prediction for circuit 15 Three Phase/ Single Phase- three wire: Phase C Apparent Power Demand Prediction for circuit 5	Rx=S15_ Pred_DMD	kVA	Float	R
2F9EH - 2F9FH	12190 - 12191	Channel 15 Peak Apparent Power Demand	Single Phase: Maximum Apparent Power Demand for circuit 15 Three Phase/ Single Phase- three wire: Maximum Phase C Apparent Power Demand for circuit 5	Rx=S15_ Max_DMD	kVA	Float	R

Address (H)	Address (D)	Parameters	Description	Relationship	Property	Data Type	Access Property
2FA0H - 2FA2H	12192 - 12194	Channel 15 Peak Apparent Power Demand Time	Single Phase: Time Stamp for Maximum Apparent Power Demand for circuit 15 Three Phase/Single Phase-three wire: Time Stamp for Maximum Phase C Apparent Power Demand for circuit 5				R
2FA3H - 2FA4H	12195 - 12196	Channel 16 Current Demand	Single Phase: Current Demand for circuit 16 Three Phase/Single Phase-three wire: Phase A Current Demand for circuit 6	Rx=I16_DMD	A	Float	R
2FA5H - 2FA6H	12197 - 12198	Channel 16 Current Demand Prediction	Single Phase: Current Demand Prediction for circuit 16 Three Phase/Single Phase-three wire: Phase A Current Demand Prediction for circuit 6	Rx=I16_Pred_DM	A	Float	R

Address (H)	Address (D)	Parameters	Description	Relationship	Property	Data Type	Access Property
2FA7H - 2FA8H	12199 - 12200	Channel 16 Peak Current Demand	Single Phase: Maximum Current Demand for circuit 16Three Phase/ Single Phase-three wire: Maximum Phase A Current Demand for circuit 6	Rx=I16_ Max_DMD	A	Float	R
2FA9H - 2FABH	12201 - 12203	Channel 16 Peak Current Demand Time	Single Phase: Time Stamp for Maximum Current Demand for circuit 16Three Phase/Single Phase- three wire: Time Stamp for Maximum Phase A Current Demand for circuit 6				R
2FACH - 2FADH	12204 - 12205	Channel 16 Power Demand	Single Phase: Power Demand for circuit 16Three Phase/ Single Phase-three wire: Phase A Power Demand for circuit 6	Rx=P16_ DMD	kW	Float	R
2FAEH - 2FAFH	12206 - 12207	Channel 16 Power Demand Prediction	Single Phase: Power Demand Prediction for circuit 16Three Phase/Single Phase- three wire: Phase A Power Demand Prediction for circuit 6	Rx=P16_ Pred_DMD	kW	Float	R

Address (H)	Address (D)	Parameters	Description	Relationship	Property	Data Type	Access Property
2FB0H - 2FB1H	12208 - 12209	Channel 16 Peak Power Demand	Single Phase: Maximum Power Demand for circuit 16 Three Phase/Single Phase-three wire: Maximum Phase A Power Demand for circuit 6	Rx=P16_Max_DMD	kW	Float	R
2FB2H - 2FB4H	12210 - 12212	Channel 16 Peak Power Demand Time	Single Phase: Time Stamp for Maximum Power Demand for circuit 16 Three Phase/Single Phase-three wire: Time Stamp for Maximum Phase A Power Demand for circuit 6				R
2FB5H - 2FB6H	12213 - 12214	Channel 16 Reactive Power Demand	Single Phase: Reactive Power Demand for circuit 16 Three Phase/Single Phase-three wire: Phase A Reactive Power Demand for circuit 6	Rx=Q16_DMD	kvar	Float	R

Address (H)	Address (D)	Parameters	Description	Relationship	Property	Data Type	Access Property
2FB7H - 2FB8H	12215 - 12216	Channel 16 Reactive Power Demand Prediction	Single Phase: Reactive Power Demand Prediction for circuit 16 Three Phase/Single Phase- three wire: Phase A Reactive Power Demand Prediction for circuit 6	Rx=Q16_ Pred_DMD	kvar	Float	R
2FB9H - 2FBAH	12217 - 12218	Channel 16 Peak Reactive Power Demand	Single Phase: Maximum Reactive Power Demand for circuit 16 Three Phase/Single Phase-three wire: Maximum Phase A Reactive Power Demand for circuit 6	Rx=Q16_ Max_DMD	kvar	Float	R
2FBBH - 2FBDH	12219 - 12221	Channel 16 Peak Reactive Power Demand Time	Single Phase: Time Stamp for Maximum Reactive Power Demand for circuit 16 Three Phase/ Single Phase-three wire: Time Stamp for Maximum Phase A Reactive Power Demand for circuit 6				R

Address (H)	Address (D)	Parameters	Description	Relationship	Property	Data Type	Access Property
2FBEH - 2FBFH	12222 - 12223	Channel 16 Apparent Power Demand	Single Phase: Apparent Power Demand for circuit 16 Three Phase/Single Phase-three wire: Phase A Apparent Power Demand for circuit 6	Rx=S16_DMD	kVA	Float	R
2FC0H - 2FC1H	12224 - 12225	Channel 16 Apparent Power Demand Prediction	Single Phase: Apparent Power Demand Prediction for circuit 16 Three Phase/Single Phase-three wire: Phase A Apparent Power Demand Prediction for circuit 6	Rx=S16_Pred_DMD	kVA	Float	R
2FC2H - 2FC3H	12226 - 12227	Channel 16 Peak Apparent Power Demand	Single Phase: Maximum Apparent Power Demand for circuit 16 Three Phase/Single Phase-three wire: Maximum Phase A Apparent Power Demand for circuit 6	Rx=S16_Max_DMD	kVA	Float	R

Address (H)	Address (D)	Parameters	Description	Relationship	Property	Data Type	Access Property
2FC4H - 2FC6H	12228 - 12230	Channel 16 Peak Apparent Power Demand Time	Single Phase: Time Stamp for Maximum Apparent Power Demand for circuit 16 Three Phase/Single Phase-three wire: Time Stamp for Maximum Phase A Apparent Power Demand for circuit 6				R
2FC7H - 2FC8H	12231 - 12232	Channel 17 Current Demand	Single Phase: Current Demand for circuit 17 Three Phase/Single Phase-three wire: Phase B Current Demand for circuit 6	Rx=I17_ DMD	A	Float	R
2FC9H - 2FCAH	12233 - 12234	Channel 17 Current Demand Prediction	Single Phase: Current Demand Prediction for circuit 17 Three Phase/Single Phase-three wire: Phase B Current Demand Prediction for circuit 6	Rx=I17_ Pred_DM	A	Float	R

Address (H)	Address (D)	Parameters	Description	Relationship	Property	Data Type	Access Property
2FCBH - 2FCCH	12235 - 12236	Channel 17 Peak Current Demand	Single Phase: Maximum Current Demand for circuit 17 Three Phase/Single Phase-three wire: Maximum Phase B Current Demand for circuit 6	Rx=I17_Max_DMD	A	Float	R
2FCDH - 2FCFH	12237 - 12239	Channel 17 Peak Current Demand Time	Single Phase: Time Stamp for Maximum Current Demand for circuit 17 Three Phase/Single Phase-three wire: Time Stamp for Maximum Phase B Current Demand for circuit 6				R
2FD0H - 2FD1H	12240 - 12241	Channel 17 Power Demand	Single Phase: Power Demand for circuit 17 Three Phase/Single Phase-three wire: Phase B Power Demand for circuit 6	Rx=P17_DMD	kW	Float	R
2FD2H - 2FD3H	12242 - 12243	Channel 17 Power Demand Prediction	Single Phase: Power Demand Prediction for circuit 17 Three Phase/Single Phase-three wire: Phase B Power Demand Prediction for circuit 6	Rx=P17_Pred_DMD	kW	Float	R

Address (H)	Address (D)	Parameters	Description	Relationship	Property	Data Type	Access Property
2FD4H - 2FD5H	12244 - 12245	Channel 17 Peak Power Demand	Single Phase: Maximum Power Demand for circuit 17Three Phase/ Single Phase-three wire: Maximum Phase B Power Demand for circuit 6	Rx=P17_ Max_DMD	kW	Float	R
2FD6H - 2FD8H	12246 - 12248	Channel 17 Peak Power Demand Time	Single Phase: Time Stamp for Maximum Power Demand for circuit 17Three Phase/Single Phase- three wire: Time Stamp for Maximum Phase B Power Demand for circuit 6				R
2FD9H - 2FDAH	12249 - 12250	Channel 17 Reactive Power Demand	Single Phase: Reactive Power Demand for circuit 17Three Phase/ Single Phase- three wire: Phase B Reactive Power Demand for circuit 6	Rx=Q17_ DMD	kvar	Float	R

Address (H)	Address (D)	Parameters	Description	Relationship	Property	Data Type	Access Property
2FDBH - 2FDCH	12251 - 12252	Channel 17 Reactive Power Demand Prediction	Single Phase: Reactive Power Demand Prediction for circuit 17 Three Phase/Single Phase-three wire: Phase B Reactive Power Demand Prediction for circuit 6	Rx=Q17_Pred_DMD	kvar	Float	R
2FDDH - 2FDEH	12253 - 12254	Channel 17 Peak Reactive Power Demand	Single Phase: Maximum Reactive Power Demand for circuit 17 Three Phase/Single Phase-three wire: Maximum Phase B Reactive Power Demand for circuit 6	Rx=Q17_Max_DMD	kvar	Float	R
2FDFH - 2FE1H	12255 - 12257	Channel 17 Peak Reactive Power Demand Time	Single Phase: Time Stamp for Maximum Reactive Power Demand for circuit 17 Three Phase/Single Phase-three wire: Time Stamp for Maximum Phase B Reactive Power Demand for circuit 6				R

Address (H)	Address (D)	Parameters	Description	Relationship	Property	Data Type	Access Property
2FE2H - 2FE3H	12258 - 12259	Channel 17 Apparent Power Demand	Single Phase: Apparent Power Demand for circuit 17 Three Phase/ Single Phase- three wire: Phase B Apparent Power Demand for circuit 6	Rx=S17_ DMD	kVA	Float	R
2FE4H - 2FE5H	12260 - 12261	Channel 17 Apparent Power Demand Prediction	Single Phase: Apparent Power Demand Prediction for circuit 17 Three Phase/ Single Phase- three wire: Phase B Apparent Power Demand Prediction for circuit 6	Rx=S17_ Pred_DMD	kVA	Float	R
2FE6H - 2FE7H	12262 - 12263	Channel 17 Peak Apparent Power Demand	Single Phase: Maximum Apparent Power Demand for circuit 17 Three Phase/ Single Phase- three wire: Maximum Phase B Apparent Power Demand for circuit 6	Rx=S17_ Max_DMD	kVA	Float	R

Address (H)	Address (D)	Parameters	Description	Relationship	Property	Data Type	Access Property
2FE8H - 2FEAH	12264 - 12266	Channel 17 Peak Apparent Power Demand Time	Single Phase: Time Stamp for Maximum Apparent Power Demand for circuit 17 Three Phase/Single Phase-three wire: Time Stamp for Maximum Phase B Apparent Power Demand for circuit 6				R
2FEBH - 2FECH	12267 - 12268	Channel 18 Current Demand	Single Phase: Current Demand for circuit 18 Three Phase/Single Phase-three wire: Phase C Current Demand for circuit 6	Rx=I18_DMD	A	Float	R
2FEDH - 2FEEH	12269 - 12270	Channel 18 Current Demand Prediction	Single Phase: Current Demand Prediction for circuit 18 Three Phase/Single Phase-three wire: Phase C Current Demand Prediction for circuit 6	Rx=I18_Pred_DM	A	Float	R

Address (H)	Address (D)	Parameters	Description	Relationship	Property	Data Type	Access Property
2FEFH - 2FF0H	12271 - 12272	Channel 18 Peak Current Demand	Single Phase: Maximum Current Demand for circuit 18 Three Phase/Single Phase-three wire: Maximum Phase C Current Demand for circuit 6	Rx=I18_Max_DMD	A	Float	R
2FF1H - 2FF3H	12273 - 12275	Channel 18 Peak Current Demand Time	Single Phase: Time Stamp for Maximum Current Demand for circuit 18 Three Phase/Single Phase-three wire: Time Stamp for Maximum Phase C Current Demand for circuit 6				R
2FF4H - 2FF5H	12276 - 12277	Channel 18 Power Demand	Single Phase: Power Demand for circuit 18 Three Phase/Single Phase-three wire: Phase C Power Demand for circuit 6	Rx=P18_DMD	kW	Float	R
2FF6H - 2FF7H	12278 - 12279	Channel 18 Power Demand Prediction	Single Phase: Power Demand Prediction for circuit 18 Three Phase/Single Phase-three wire: Phase C Power Demand Prediction for circuit 6	Rx=P18_Pred_DMD	kW	Float	R

Address (H)	Address (D)	Parameters	Description	Relationship	Property	Data Type	Access Property
2FF8H - 2FF9H	12280 - 12281	Channel 18 Peak Power Demand	Single Phase: Maximum Power Demand for circuit 18 Three Phase/Single Phase-three wire: Maximum Phase C Power Demand for circuit 6	Rx=P18_Max_DMD	kW	Float	R
2FFAH - 2FFCH	12282 - 12284	Channel 18 Peak Power Demand Time	Single Phase: Time Stamp for Maximum Power Demand for circuit 18 Three Phase/Single Phase-three wire: Time Stamp for Maximum Phase C Power Demand for circuit 6				R
2FFDH - 2FFEH	12285 - 12286	Channel 18 Reactive Power Demand	Single Phase: Reactive Power Demand for circuit 18 Three Phase/Single Phase-three wire: Phase C Reactive Power Demand for circuit 6	Rx=Q18_DMD	kvar	Float	R
2FFFH - 3000H	12287 - 12288	Channel 18 Reactive Power Demand Prediction	Single Phase: Reactive Power Demand Prediction for circuit 18 Three Phase/Single Phase-three wire: Phase C Reactive Power Demand Prediction for circuit 6	Rx=Q18_Pred_DMD	kvar	Float	R

Address (H)	Address (D)	Parameters	Description	Relationship	Property	Data Type	Access Property
3001H - 3002H	12289 - 12290	Channel 18 Peak Reactive Power Demand	Single Phase: Maximum Reactive Power Demand for circuit 18 Three Phase/ Single Phase-three wire: Maximum Phase C Reactive Power Demand for circuit 6	Rx=Q18_Max_DMD	kvar	Float	R
3003H - 3005H	12291 - 12293	Channel 18 Peak Reactive Power Demand Time	Single Phase: Time Stamp for Maximum Reactive Power Demand for circuit 18 Three Phase/ Single Phase-three wire: Time Stamp for Maximum Phase C Reactive Power Demand for circuit 6				R
3006H - 3007H	12294 - 12295	Channel 18 Apparent Power Demand	Single Phase: Apparent Power Demand for circuit 18 Three Phase/ Single Phase-three wire: Phase C Apparent Power Demand for circuit 6	Rx=S18_DMD	kVA	Float	R

Address (H)	Address (D)	Parameters	Description	Relationship	Property	Data Type	Access Property
3008H - 3009H	12296 - 12297	Channel 18 Apparent Power Demand Prediction	Single Phase: Apparent Power Demand Prediction for circuit 18 Three Phase/Single Phase-three wire: Phase C Apparent Power Demand Prediction for circuit 6	Rx=S18_Pred_DMD	kVA	Float	R
300AH - 300BH	12298 - 12299	Channel 18 Peak Apparent Power Demand	Single Phase: Maximum Apparent Power Demand for circuit 18 Three Phase/Single Phase-three wire: Maximum Phase C Apparent Power Demand for circuit 6	Rx=S18_Max_DMD	kVA	Float	R
300CH - 300EH	12300 - 12302	Channel 18 Peak Apparent Power Demand Time	Single Phase: Time Stamp for Maximum Apparent Power Demand for circuit 18 Three Phase/Single Phase-three wire: Time Stamp for Maximum Phase C Apparent Power Demand for circuit 6				R
300FH - 3010H	12303 - 12304	User Channel 1 Total Power Demand	Three Phase-four wire/Single Phase-three-wire: Total Power Demand for circuit 1	Rx=P1_DMD	kW	Float	R

Address (H)	Address (D)	Parameters	Description	Relationship	Property	Data Type	Access Property
3011H - 3012H	12305 - 12306	User Channel 1 Total Power Demand Prediction	Three Phase-four wire/Single Phase-three-wire: Total Power Demand Prediction for circuit 1	Rx=P1_Pred_DMD	kW	Float	R
3013H - 3014H	12307 - 12308	User Channel 1 Total Power Demand Peak	Three Phase-four wire/Single Phase-three-wire: Maximum Total Power Demand for circuit 1	Rx=P1_Max_DMD	kW	Float	R
3015H - 3017H	12309 - 12311	User Channel 1 Total Power Demand Peak Time	Three Phase-four wire/Single Phase-three-wire: Time Stamp for Maximum Total Power Demand for circuit 1				R
3018H - 3019H	12312 - 12313	User Channel 1 Total Reactive Power Demand	Three Phase-four wire/Single Phase-three-wire: Total Reactive Power Demand for circuit 1	Rx=Q1_DMD	kvar	Float	R
301AH - 301BH	12314 - 12315	User Channel 1 Total Reactive Power Demand Prediction	Three Phase-four wire/Single Phase-three-wire: Total Reactive Power Demand Prediction for circuit 1	Rx=Q1_Pred_DMD	kvar	Float	R

Address (H)	Address (D)	Parameters	Description	Relationship	Property	Data Type	Access Property
301CH - 301DH	12316 - 12317	User Channel 1 Total Reactive Power Demand Peak	Three Phase-four wire/Single Phase-three-wire: Maximum Total Reactive Power Demand for circuit 1	Rx=Q1_Max_DMD	kvar	Float	R
301EH - 3020H	12318 - 12320	User Channel 1 Total Reactive Power Demand Peak Time	Three Phase-four wire/Single Phase-three-wire: Time Stamp for Maximum Total Reactive Power Demand for circuit 1				R
3021H - 3022H	12321 - 12322	User Channel 1 Total Apparent Power Demand	Three Phase-four wire/Single Phase-three-wire: Total Apparent Power Demand for circuit 1	Rx=S1_DMD	kVA	Float	R
3023H - 3024H	12323 - 12324	User Channel 1 Total Apparent Power Demand Prediction	Three Phase-four wire/Single Phase-three-wire: Total Apparent Power Demand Prediction for circuit 1	Rx=S1_Pred_DMD	kVA	Float	R

Address (H)	Address (D)	Parameters	Description	Relationship	Property	Data Type	Access Property
3025H - 3026H	12325 - 12326	User Channel 1 Total Apparent Power Demand Peak	Three Phase-four wire/Single Phase-three-wire: Maximum Total Apparent Power Demand for circuit 1	Rx=S1_Max_DMD	kVA	Float	R
3027H - 3029H	12327 - 12329	User Channel 1 Total Apparent Power Demand Peak Time	Three Phase-four wire/Single Phase-three-wire: Time Stamp for Maximum Total Apparent Power Demand for circuit 1				R
302AH - 302BH	12330 - 12331	User Channel 2 Total Power Demand	Three Phase-four wire/Single Phase-three-wire: Total Power Demand for circuit 2	Rx=P2_DMD	kW	Float	R
302CH - 302DH	12332 - 12333	User Channel 2 Total Power Demand Prediction	Three Phase-four wire/Single Phase-three-wire: Total Power Demand Prediction for circuit 2	Rx=P2_Pred_DMD	kW	Float	R
302EH - 302FH	12334 - 12335	User Channel 2 Total Power Demand Peak	Three Phase-four wire/Single Phase-three-wire: Maximum Total Power Demand for circuit 2	Rx=P2_Max_DMD	kW	Float	R

Address (H)	Address (D)	Parameters	Description	Relationship	Property	Data Type	Access Property
3030H - 3032H	12336 - 12338	User Channel 2 Total Power Demand Peak Time	Three Phase-four wire/Single Phase-three-wire: Time Stamp for Maximum Total Power Demand for circuit 2				R
3033H - 3034H	12339 - 12340	User Channel 2 Total Reactive Power Demand	Three Phase-four wire/Single Phase-three-wire: Total Reactive Power Demand for circuit 2	Rx=Q2_DMD	kvar	Float	R
3035H - 3036H	12341 - 12342	User Channel 2 Total Reactive Power Demand Prediction	Three Phase-four wire/Single Phase-three-wire: Total Reactive Power Demand Prediction for circuit 2	Rx=Q2_Pred_DMD	kvar	Float	R
3037H - 3038H	12343 - 12344	User Channel 2 Total Reactive Power Demand Peak	Three Phase-four wire/Single Phase-three-wire: Maximum Total Reactive Power Demand for circuit 2	Rx=Q2_Max_DMD	kvar	Float	R
3039H - 303BH	12345 - 12347	User Channel 2 Total Reactive Power Demand Peak Time	Three Phase-four wire/Single Phase-three-wire: Time Stamp for Maximum Total Reactive Power Demand for circuit 2				R

Address (H)	Address (D)	Parameters	Description	Relationship	Property	Data Type	Access Property
303CH - 303DH	12348 - 12349	User Channel 2 Total Apparent Power Demand	Three Phase-four wire/Single Phase-three-wire: Total Apparent Power Demand for circuit 2	Rx=S2_DMD	kVA	Float	R
303EH - 303FH	12350 - 12351	User Channel 2 Total Apparent Power Demand Prediction	Three Phase-four wire/Single Phase-three-wire: Total Apparent Power Demand Prediction for circuit 2	Rx=S2_Pred_DMD	kVA	Float	R
3040H - 3041H	12352 - 12353	User Channel 2 Total Apparent Power Demand Peak	Three Phase-four wire/Single Phase-three-wire: Maximum Total Apparent Power Demand for circuit 2	Rx=S2_Max_DMD	kVA	Float	R
3042H - 3044H	12354 - 12356	User Channel 2 Total Apparent Power Demand Peak Time	Three Phase-four wire/Single Phase-three-wire: Time Stamp for Maximum Total Apparent Power Demand for circuit 2				R
3045H - 3046H	12357 - 12358	User Channel 3 Total Power Demand	Three Phase-four wire/Single Phase-three-wire: Total Power Demand for circuit 3	Rx=P3_DMD	kW	Float	R

Address (H)	Address (D)	Parameters	Description	Relationship	Property	Data Type	Access Property
3047H - 3048H	12359 - 12360	User Channel 3 Total Power Demand Prediction	Three Phase-four wire/Single Phase-three-wire: Total Power Demand Prediction for circuit 3	Rx=P3_Pred_DMD	kW	Float	R
3049H - 304AH	12361 - 12362	User Channel 3 Total Power Demand Peak	Three Phase-four wire/Single Phase-three-wire: Maximum Total Power Demand for circuit 3	Rx=P3_Max_DMD	kW	Float	R
304BH - 304DH	12363 - 12365	User Channel 3 Total Power Demand Peak Time	Three Phase-four wire/Single Phase-three-wire: Time Stamp for Maximum Total Power Demand for circuit 3				R
304EH - 304FH	12366 - 12367	User Channel 3 Total Reactive Power Demand	Three Phase-four wire/Single Phase-three-wire: Total Reactive Power Demand for circuit 3	Rx=Q3_DMD	kvar	Float	R

Address (H)	Address (D)	Parameters	Description	Relationship	Property	Data Type	Access Property
3050H - 3051H	12368 - 12369	User Channel 3 Total Reactive Power Demand Prediction	Three Phase-four wire/Single Phase-three-wire: Total Reactive Power Demand Prediction for circuit 3	Rx=Q3_Pred_DMD	kvar	Float	R
3052H - 3053H	12370 - 12371	User Channel 3 Total Reactive Power Demand Peak	Three Phase-four wire/Single Phase-three-wire: Maximum Total Reactive Power Demand for circuit 3	Rx=Q3_Max_DMD	kvar	Float	R
3054H - 3056H	12372 - 12374	User Channel 3 Total Reactive Power Demand Peak Time	Three Phase-four wire/Single Phase-three-wire: Time Stamp for Maximum Total Reactive Power Demand for circuit 3				R
3057H - 3058H	12375 - 12376	User Channel 3 Total Apparent Power Demand	Three Phase-four wire/Single Phase-three-wire: Total Apparent Power Demand for circuit 3	Rx=S3_DMD	kVA	Float	R

Address (H)	Address (D)	Parameters	Description	Relationship	Property	Data Type	Access Property
3059H - 305AH	12377 - 12378	User Channel 3 Total Apparent Power Demand Prediction	Three Phase- four wire/Single Phase-three-wire: Total Apparent Power Demand Prediction for circuit 3	Rx=S3_ Pred_DMD	kVA	Float	R
305BH - 305CH	12379 - 12380	User Channel 3 Total Apparent Power Demand Peak	Three Phase- four wire/Single Phase-three- wire: Maximum Total Apparent Power Demand for circuit 3	Rx=S3_ Max_DMD	kVA	Float	R
305DH - 305FH	12381 - 12383	User Channel 3 Total Apparent Power Demand Peak Time	Three Phase-four wire/Single Phase- three-wire: Time Stamp for Maximum Total Apparent Power Demand for circuit 3				R
3060H - 3061H	12384 - 12385	User Channel 4 Total Power Demand	Three Phase-four wire/Single Phase- three-wire: Total Power Demand for circuit 4	Rx=P4_ DMD	kW	Float	R
3062H - 3063H	12386 - 12387	User Channel 4 Total Power Demand Prediction	Three Phase-four wire/Single Phase- three-wire: Total Power Demand Prediction for circuit 4	Rx=P4_ Pred_DMD	kW	Float	R

Address (H)	Address (D)	Parameters	Description	Relationship	Property	Data Type	Access Property
3064H - 3065H	12388 - 12389	User Channel 4 Total Power Demand Peak	Three Phase-four wire/Single Phase-three-wire: Maximum Total Power Demand for circuit 4	Rx=P4_Max_DMD	kW	Float	R
3066H - 3068H	12390 - 12392	User Channel 4 Total Power Demand Peak Time	Three Phase-four wire/Single Phase-three-wire: Time Stamp for Maximum Total Power Demand for circuit 4				R
3069H - 306AH	12393 - 12394	User Channel 4 Total Reactive Power Demand	Three Phase-four wire/Single Phase-three-wire: Total Reactive Power Demand for circuit 4	Rx=Q4_DMD	kvar	Float	R
306BH - 306CH	12395 - 12396	User Channel 4 Total Reactive Power Demand Prediction	Three Phase-four wire/Single Phase-three-wire: Total Reactive Power Demand Prediction for circuit 4	Rx=Q4_Pred_DMD	kvar	Float	R
306DH - 306EH	12397 - 12398	User Channel 4 Total Reactive Power Demand Peak	Three Phase-four wire/Single Phase-three-wire: Maximum Total Reactive Power Demand for circuit 4	Rx=Q4_Max_DMD	kvar	Float	R

Address (H)	Address (D)	Parameters	Description	Relationship	Property	Data Type	Access Property
306FH - 3071H	12399 - 12401	User Channel 4 Total Reactive Power Demand Peak Time	Three Phase-four wire/Single Phase-three-wire: Time Stamp for Maximum Total Reactive Power Demand for circuit 4				R
3072H - 3073H	12402 - 12403	User Channel 4 Total Apparent Power Demand	Three Phase-four wire/Single Phase-three-wire: Total Apparent Power Demand for circuit 4	Rx=S4_DMD	kVA	Float	R
3074H - 3075H	12404 - 12405	User Channel 4 Total Apparent Power Demand Prediction	Three Phase-four wire/Single Phase-three-wire: Total Apparent Power Demand Prediction for circuit 4	Rx=S4_Pred_DMD	kVA	Float	R
3076H - 3077H	12406 - 12407	User Channel 4 Total Apparent Power Demand Peak	Three Phase-four wire/Single Phase-three-wire: Maximum Total Apparent Power Demand for circuit 4	Rx=S4_Max_DMD	kVA	Float	R

Address (H)	Address (D)	Parameters	Description	Relationship	Property	Data Type	Access Property
3078H - 307AH	12408 - 12410	User Channel 4 Total Apparent Power Demand Peak Time	Three Phase-four wire/Single Phase-three-wire: Time Stamp for Maximum Total Apparent Power Demand for circuit 4				R
307BH - 307CH	12411 - 12412	User Channel 5 Total Power Demand	Three Phase-four wire/Single Phase-three-wire: Total Power Demand for circuit 5	Rx=P5_DMD	kW	Float	R
307DH - 307EH	12413 - 12414	User Channel 5 Total Power Demand Prediction	Three Phase-four wire/Single Phase-three-wire: Total Power Demand Prediction for circuit 5	Rx=P5_Pred_DMD	kW	Float	R
307FH - 3080H	12415 - 12416	User Channel 5 Total Power Demand Peak	Three Phase-four wire/Single Phase-three-wire: Maximum Total Power Demand for circuit 5	Rx=P5_Max_DMD	kW	Float	R
3081H - 3083H	12417 - 12419	User Channel 5 Total Power Demand Peak Time	Three Phase-four wire/Single Phase-three-wire: Time Stamp for Maximum Total Power Demand for circuit 5				R

Address (H)	Address (D)	Parameters	Description	Relationship	Property	Data Type	Access Property
3084H - 3085H	12420 - 12421	User Channel 5 Total Reactive Power Demand	Three Phase-four wire/Single Phase-three-wire: Total Reactive Power Demand for circuit 5	Rx=Q5_DMD	kvar	Float	R
3086H - 3087H	12422 - 12423	User Channel 5 Total Reactive Power Demand Prediction	Three Phase-four wire/Single Phase-three-wire: Total Reactive Power Demand Prediction for circuit 5	Rx=Q5_Pred_DMD	kvar	Float	R
3088H - 3089H	12424 - 12425	User Channel 5 Total Reactive Power Demand Peak	Three Phase-four wire/Single Phase-three-wire: Maximum Total Reactive Power Demand for circuit 5	Rx=Q5_Max_DMD	kvar	Float	R
308AH - 308CH	12426 - 12428	User Channel 5 Total Reactive Power Demand Peak Time	Three Phase-four wire/Single Phase-three-wire: Time Stamp for Maximum Total Reactive Power Demand for circuit 5				R
308DH - 308EH	12429 - 12430	User Channel 5 Total Apparent Power Demand	Three Phase-four wire/Single Phase-three-wire: Total Apparent Power Demand for circuit 5	Rx=S5_DMD	kVA	Float	R

Address (H)	Address (D)	Parameters	Description	Relationship	Property	Data Type	Access Property
308FH - 3090H	12431 - 12432	User Channel 5 Total Apparent Power Demand Prediction	Three Phase-four wire/Single Phase-three-wire: Total Apparent Power Demand Prediction for circuit 5	Rx=S5_Pred_DMD	kVA	Float	R
3091H - 3092H	12433 - 12434	User Channel 5 Total Apparent Power Demand Peak	Three Phase-four wire/Single Phase-three-wire: Maximum Total Apparent Power Demand for circuit 5	Rx=S5_Max_DMD	kVA	Float	R
3093H - 3095H	12435 - 12437	User Channel 5 Total Apparent Power Demand Peak Time	Three Phase-four wire/Single Phase-three-wire: Time Stamp for Maximum Total Apparent Power Demand for circuit 5				R
3096H - 3097H	12438 - 12439	User Channel 6 Total Power Demand	Three Phase-four wire/Single Phase-three-wire: Total Power Demand for circuit 6	Rx=P6_DMD	kW	Float	R
3098H - 3099H	12440 - 12441	User Channel 6 Total Power Demand Prediction	Three Phase-four wire/Single Phase-three-wire: Total Power Demand Prediction for circuit 6	Rx=P6_Pred_DMD	kW	Float	R

Address (H)	Address (D)	Parameters	Description	Relationship	Property	Data Type	Access Property
309AH - 309BH	12442 - 12443	User Channel 6 Total Power Demand Peak	Three Phase-four wire/Single Phase-three-wire: Maximum Total Power Demand for circuit 6	Rx=P6_Max_DMD	kW	Float	R
309CH - 309EH	12444 - 12446	User Channel 6 Total Power Demand Peak Time	Three Phase-four wire/Single Phase-three-wire: Time Stamp for Maximum Total Power Demand for circuit 6				R
309FH - 30A0H	12447 - 12448	User Channel 6 Total Reactive Power Demand	Three Phase-four wire/Single Phase-three-wire: Total Reactive Power Demand for circuit 6	Rx=Q6_DMD	kvar	Float	R
30A1H - 30A2H	12449 - 12450	User Channel 6 Total Reactive Power Demand Prediction	Three Phase-four wire/Single Phase-three-wire: Total Reactive Power Demand Prediction for circuit 6	Rx=Q6_Pred_DMD	kvar	Float	R
30A3H - 30A4H	12451 - 12452	User Channel 6 Total Reactive Power Demand Peak	Three Phase-four wire/Single Phase-three-wire: Maximum Total Reactive Power Demand for circuit 6	Rx=Q6_Max_DMD	kvar	Float	R

Address (H)	Address (D)	Parameters	Description	Relationship	Property	Data Type	Access Property
30A5H - 30A7H	12543 - 12455	User Channel 6 Total Reactive Power Demand Peak Time	Three Phase-four wire/Single Phase-three-wire: Time Stamp for Maximum Total Reactive Power Demand for circuit 6				R
30A8H - 30A9H	12456 - 12457	User Channel 6 Total Apparent Power Demand	Three Phase-four wire/Single Phase-three-wire: Total Apparent Power Demand for circuit 6	Rx=S6_DMD	kVA	Float	R
30AAH - 30ABH	12458 - 12459	User Channel 6 Total Apparent Power Demand Prediction	Three Phase-four wire/Single Phase-three-wire: Total Apparent Power Demand Prediction for circuit 6	Rx=S6_Pred_DMD	kVA	Float	R
30ACH - 30ADH	12460 - 12461	User Channel 6 Total Apparent Power Demand Peak	Three Phase-four wire/Single Phase-three-wire: Maximum Total Apparent Power Demand for circuit 6	Rx=S6_Max_DMD	kVA	Float	R

Address (H)	Address (D)	Parameters	Description	Relationship	Property	Data Type	Access Property
30AEH - 30BOH	12462 - 12464	User Channel 6 Total Apparent Power Demand Peak Time	Three Phase-four wire/Single Phase-three-wire: Time Stamp for Maximum Total Apparent Power Demand for circuit 6				R
30B1- 30B2	12465 - 12466	User Channel 7 Total Power Demand	Two Phase Three Wire: Total Power Demand for Circuit 7	Rx=P7_ DMD	kW	Float	R
30B3- 30B4	12467 - 12468	User Channel 7 Total Power Demand Prediction	Two Phase Three Wire: Total Power Demand Prediction for Circuit 7	Rx=P7_ Pred_DMD	kW	Float	R
30B5- 30B6	12469- 12470	User Channel 7 Total Power Demand Peak	Two Phase Three Wire: Maximum Total Power Demand for Circuit 7	Rx=P7_ Max_DMD	kW	Float	R
30B7- 30B9	12471 - 12473	User Channel 7 Total Power Demand Peak Time	Two Phase Three Wire: Time Stamp for Maximum Total Power Demand for Circuit 7				R

Address (H)	Address (D)	Parameters	Description	Relationship	Property	Data Type	Access Property
30BA-30BB	12474 - 12475	User Channel 7 Total Reactive Power Demand	Two Phase Three Wire: Total Active Power Demand for Circuit 7	Rx=Q7_DMD	kvar	Float	R
30BC-30BD	12476 - 12477	User Channel 7 Total Reactive Power Demand Prediction	Two Phase Three Wire: Total Reactive Power Demand Prediction for Circuit 7	Rx=Q7_Pred_DMD	kvar	Float	R
30BE-30BF	12478 - 12479	User Channel 7 Total Reactive Power Demand Peak	Two Phase Three Wire: Maximum Total Reactive Power Demand for Circuit 7	Rx=Q7_Max_DMD	kvar	Float	R
30C0-30C2	12480 - 12482	User Channel 7 Total Reactive Power Demand Peak Time	Two Phase Three Wire: Time Stamp for Maximum Total Reactive Power Demand for Circuit 7				R
30C3-30C4	12483 - 12484	User Channel 7 Total Apparent Power Demand	Two Phase Three Wire: Total Active Power Demand for Circuit 7	Rx=S7_DMD	kVA	Float	R

Address (H)	Address (D)	Parameters	Description	Relationship	Property	Data Type	Access Property
30C5-30C6	12485 - 12486	User Channel 7 Total Apparent Power Demand Prediction	Two Phase Three Wire: Total Reactive Power Demand Prediction for Circuit 7	Rx=S7_Pred_DMD	kVA	Float	R
30C7-30C8	12487 - 12488	User Channel 7 Total Apparent Power Demand Peak	Two Phase Three Wire: Maximum Total Reactive Power Demand for Circuit 7	Rx=S7_Max_DMD	kVA	Float	R
30C9-30CB	12489-12491	User Channel 7 Total Apparent Power Demand Peak Time	Two Phase Three Wire: Time Stamp for Maximum Total Reactive Power Demand for Circuit 7				R
30CC-30CD	12492-12493	User Channel 8 Total Power Demand	Two Phase Three Wire: Total Power Demand for Circuit 8	Rx=P8_DMD	kW	Float	R
30CE-30CF	12494-12495	User Channel 8 Total Power Demand Prediction	Two Phase Three Wire: Total Power Demand Prediction for Circuit 8	Rx=P8_Pred_DMD	kW	Float	R

Address (H)	Address (D)	Parameters	Description	Relationship	Property	Data Type	Access Property
30D0-30D1	12496-12497	User Channel 8 Total Power Demand Peak	Two Phase Three Wire: Maximum Total Power Demand for Circuit 8	Rx=P8_Max_DMD	kW	Float	R
30D2-30D4	12498-12500	User Channel 8 Total Power Demand Peak Time	Two Phase Three Wire: Time Stamp for Maximum Total Power Demand for Circuit 8				R
30D5-30D6	12501-12502	User Channel 8 Total Reactive Power Demand	Two Phase Three Wire: Total Active Power Demand for Circuit 8	Rx=Q8_DMD	kvar	Float	R
30D7-30D8	12503-12504	User Channel 8 Total Reactive Power Demand Prediction	Two Phase Three Wire: Total Reactive Power Demand Prediction for Circuit 8	Rx=Q8_Pred_DMD	kvar	Float	R
30D9-30DA	12505-12506	User Channel 8 Total Reactive Power Demand Peak	Two Phase Three Wire: Maximum Total Reactive Power Demand for Circuit 8	Rx=Q8_Max_DMD	kvar	Float	R

Address (H)	Address (D)	Parameters	Description	Relationship	Property	Data Type	Access Property
30DB-30DD	12507-12509	User Channel 8 Total Reactive Power Demand Peak Time	Two Phase Three Wire: Time Stamp for Maximum Total Reactive Power Demand for Circuit 8				R
30DE-30DF	12510-12511	User Channel 8 Total Apparent Power Demand	Two Phase Three Wire: Total Active Power Demand for Circuit 8	Rx=S8_DMD	kVA	Float	R
30E0-30E1	12512-12513	User Channel 8 Total Apparent Power Demand Prediction	Two Phase Three Wire: Total Reactive Power Demand Prediction for Circuit 8	Rx=S8_Pred_DMD	kVA	Float	R
30E2-30E3	12514-12515	User Channel 8 Total Apparent Power Demand Peak	Two Phase Three Wire: Maximum Total Reactive Power Demand for Circuit 8	Rx=S8_Max_DMD	kVA	Float	R

Address (H)	Address (D)	Parameters	Description	Relationship	Property	Data Type	Access Property
30E4-30E6	12516-12518	User Channel 8 Total Apparent Power Demand Peak Time	Two Phase Three Wire: Time Stamp for Maximum Total Reactive Power Demand for Circuit 8				R
30E7-30E8	12519-12520	User Channel 9 Total Power Demand	Two Phase Three Wire: Total Power Demand for Circuit 9	Rx=P9_DMD	KW	Float	R
30E9-30EA	12521-12522	User Channel 9 Total Power Demand Prediction	Two Phase Three Wire: Total Power Demand Prediction for Circuit 9	Rx=P9_Pred_DMD	KW	Float	R
30EB-30EC	12523-12524	User Channel 9 Total Power Demand Peak	Two Phase Three Wire: Maximum Total Power Demand for Circuit 9	Rx=P9_Max_DMD	KW	Float	R
30ED-30EF	12525-12527	User Channel 9 Total Power Demand Peak Time	Two Phase Three Wire: Time Stamp for Maximum Total Power Demand for Circuit 9				R

Address (H)	Address (D)	Parameters	Description	Relationship	Property	Data Type	Access Property
30F0-30F1	12528-12529	User Channel 9 Total Reactive Power Demand	Two Phase Three Wire: Total Active Power Demand for Circuit 9	Rx=Q9_DMD	kvar	Float	R
30F2-30F3	12530-12531	User Channel 9 Total Reactive Power Demand Prediction	Two Phase Three Wire: Total Reactive Power Demand Prediction for Circuit 9	Rx=Q9_Pred_DMD	kvar	Float	R
30F4-30F5	12532-12533	User Channel 9 Total Reactive Power Demand Peak	Two Phase Three Wire: Maximum Total Reactive Power Demand for Circuit 9	Rx=Q9_Max_DMD	kvar	Float	R
30F6-30F8	12534-12536	User Channel 9 Total Reactive Power Demand Peak Time	Two Phase Three Wire: Time Stamp for Maximum Total Reactive Power Demand for Circuit 9				R
30F9-30FA	12537-12538	User Channel 9 Total Apparent Power Demand	Two Phase Three Wire: Total Active Power Demand for Circuit 9	Rx=S9_DMD	kVA	Float	R

Address (H)	Address (D)	Parameters	Description	Relationship	Property	Data Type	Access Property
30FB-30FC	12539-12540	User Channel 9 Total Apparent Power Demand Prediction	Two Phase Three Wire: Total Reactive Power Demand Prediction for Circuit 9	Rx=S9_Pred_DMD	kVA	Float	R
30FD-30FE	12541-12542	User Channel 9 Total Apparent Power Demand Peak	Two Phase Three Wire: Maximum Total Reactive Power Demand for Circuit 9	Rx=S9_Max_DMD	kVA	Float	R
30FF-3101	12543-12545	User Channel 9 Total Apparent Power Demand Peak Time	Two Phase Three Wire: Time Stamp for Maximum Total Reactive Power Demand for Circuit 9				R

Power Quality

Address (H)	Address (D)	Parameter	Range	Data Type	Access Property
Incoming Power Quality					
3200H	12800	Voltage Unbalance		word	R
3201H	12801	U1 or U12 Harmonic Distortion THD-U1		word	R
3202H	12802	U2 or U23 Harmonic Distortion THD-U2		word	R

Address (H)	Address (D)	Parameter	Range	Data Type	Access Property
3203H	12803	U3 or U31 Harmonic Distortion THD-U3		word	R
3204H	12804	Average Voltage Harmonic Distortion		word	R
3205H	12805	U1 or U12 2nd Harmonic		word	R
3206H	12806	U1 or U12 3rd Harmonic		word	R
.....			word	R
3222H	12834	U1 or U12 31st Harmonic		word	R
3223H	12835	U2 or U23 2nd Harmonic		word	R
3224H	12836	U2 or U23 3rd Harmonic		word	R
.....			word	R
3240H	12864	U2 or U23 31st Harmonic		word	R
3241H	12865	U3 or U31 2nd Harmonic		word	R
3242H	12866	U3 or U31 3rd Harmonic		word	R
.....			word	R
325EH	12894	U3 or U31 31st Harmonic		word	R
325FH	12895	Current Unbalance		Word	R
3260H	12896	U1 Odd Harmonic Distortion		Word	R
3261H	12897	U1 Even Harmonic Distortion		Word	R
3262H	12898	U1 Crest Factor		Word	R
3263H	12899	U1 Telephone Harmonic Form Factor		Word	R
3264H	12900	U2 Odd Harmonic Distortion		Word	R
3265H	12901	U2 Even Harmonic Distortion		Word	R

Address (H)	Address (D)	Parameter	Range	Data Type	Access Property
3266H	12902	U2 Crest Factor		Word	R
3267H	12903	U2 Telephone Harmonic Form Factor		Word	R
3268H	12904	U3 Odd Harmonic Distortion		Word	R
3269H	12905	U3 Even Harmonic Distortion		Word	R
326AH	12906	U3 Crest Factor		Word	R
326BH	12907	U3 Telephone Harmonic Form Factor		Word	R
32A0H	12960	Channel 1 Current Odd Harmonic Distortion		Word	R
32A1H	12961	Channel 1 Current Even Harmonic Distortion		Word	R
32A2H	12962	Channel 1 Current K Factor		Word	R
32A3H	12963	Channel 2 Current Odd Harmonic Distortion		Word	R
32A4H	12964	Channel 2 Current Even Harmonic Distortion		Word	R
32A5H	12965	Channel 2 Current K Factor		Word	R
32A6H	12966	Channel 3 Current Odd Harmonic Distortion		Word	R
32A7H	12967	Channel 3 Current Even Harmonic Distortion		Word	R
32A8H	12968	Channel 3 Current K Factor		Word	R
32A9H	12969	Channel 4 Current Odd Harmonic Distortion		Word	R

Address (H)	Address (D)	Parameter	Range	Data Type	Access Property
32AAH	12970	Channel 4 Current Even Harmonic Distortion		Word	R
32ABH	12971	Channel 4 Current K Factor		Word	R
32ACH	12972	Channel 5 Current Odd Harmonic Distortion		Word	R
32ADH	12973	Channel 5 Current Even Harmonic Distortion		Word	R
32AEH	12974	Channel 5 Current K Factor		Word	R
32AFH	12975	Channel 6 Current Odd Harmonic Distortion		Word	R
32B0H	12976	Channel 6 Current Even Harmonic Distortion		Word	R
32B1H	12977	Channel 6 Current K Factor		Word	R
32B2H	12978	Channel 7 Current Odd Harmonic Distortion		Word	R
32B3H	12979	Channel 7 Current Even Harmonic Distortion		Word	R
32B4H	12980	Channel 7 Current K Factor		Word	R
32B5H	12981	Channel 8 Current Odd Harmonic Distortion		Word	R
32B6H	12982	Channel 8 Current Even Harmonic Distortion		Word	R
32B7H	12983	Channel 8 Current K Factor		Word	R
32B8H	12984	Channel 9 Current Odd Harmonic Distortion		Word	R

Address (H)	Address (D)	Parameter	Range	Data Type	Access Property
32B9H	12985	Channel 9 Current Even Harmonic Distortion		Word	R
32BAH	12986	Channel 9 Current K Factor		Word	R
32BBH	12987	Channel 10 Current Odd Harmonic Distortion		Word	R
32BCH	12988	Channel 10 Current Even Harmonic Distortion		Word	R
32BDH	12989	Channel 10 Current K Factor		Word	R
32BEH	12990	Channel 11 Current Odd Harmonic Distortion		Word	R
32BFH	12991	Channel 11 Current Even Harmonic Distortion		Word	R
32C0H	12992	Channel 11 Current K Factor		Word	R
32C1H	12993	Channel 12 Current Odd Harmonic Distortion		Word	R
32C2H	12994	Channel 12 Current Even Harmonic Distortion		Word	R
32C3H	12995	Channel 12 Current K Factor		Word	R
32C4H	12996	Channel 13 Current Odd Harmonic Distortion		Word	R
32C5H	12997	Channel 13 Current Even Harmonic Distortion		Word	R
32C6H	12998	Channel 13 Current K Factor		Word	R
32C7H	12999	Channel 14 Current Odd Harmonic Distortion		Word	R
32C8H	13000	Channel 14 Current Even Harmonic Distortion		Word	R

Address (H)	Address (D)	Parameter	Range	Data Type	Access Property
32C9H	13001	Channel 14 Current K Factor		Word	R
32CAH	13002	Channel 15 Current Odd Harmonic Distortion		Word	R
32CBH	13003	Channel 15 Current Even Harmonic Distortion		Word	R
32CCH	13004	Channel 15 Current K Factor		Word	R
32CDH	13005	Channel 16 Current Odd Harmonic Distortion		Word	R
32CEH	13006	Channel 16 Current Even Harmonic Distortion		Word	R
32CFH	13007	Channel 16 Current K Factor		Word	R
32D0H	13008	Channel 17 Current Odd Harmonic Distortion		Word	R
32D1H	13009	Channel 17 Current Even Harmonic Distortion		Word	R
32D2H	13010	Channel 17 Current K Factor		Word	R
32D3H	13011	Channel 18 Current Odd Harmonic Distortion		Word	R
32D4H	13012	Channel 18 Current Even Harmonic Distortion		Word	R
32D5H	13013	Channel 18 Current K Factor		Word	R
18 Single - Phase Data					
3300H	13056	Channel 1 Current THD-I1		word	R
3301H	13057	Channel 1 Current 2nd Harmonic		word	R
.....			word	R
331EH	13086	Channel 1 Current 31st Harmonic		word	R

Address (H)	Address (D)	Parameter	Range	Data Type	Access Property
331FH - 333DH	13087 - 13117	Channel 2 Current Harmonic Data	Same as Channel 1	word	R
333EH - 335CH	13118 - 13148	Channel 3 Current Harmonic Data	Same as Channel 1	word	R
335DH - 337BH	13149 - 13179	Channel 4 Current Harmonic Data	Same as Channel 1	word	R
337CH - 339AH	13180 - 13210	Channel 5 Current Harmonic Data	Same as Channel 1	word	R
339BH - 33B9H	13211 - 13241	Channel 6 Current Harmonic Data	Same as Channel 1	word	R
33BAH - 33D8H	13242 - 13272	Channel 7 Current Harmonic Data	Same as Channel 1	word	R
33D9H - 33F7H	13273 - 13303	Channel 8 Current Harmonic Data	Same as Channel 1	word	R
33F8H - 3416H	13304 - 13334	Channel 9 Current Harmonic Data	Same as Channel 1	word	R
3417H - 3435H	13335 - 13365	Channel 10 Current Harmonic Data	Same as Channel 1	word	R
3436H - 3454H	13366 - 13396	Channel 11 Current Harmonic Data	Same as Channel 1	word	R

AcuRev 2100 Series Power Meter

Address (H)	Address (D)	Parameter	Range	Data Type	Access Property
3455H - 3473H	13397 - 13427	Channel 12 Current Harmonic Data	Same as Channel 1	word	R
3474H - 3492H	13428 - 13458	Channel 13 Current Harmonic Data	Same as Channel 1	word	R
3493H - 34B1H	13459 - 13489	Channel 14 Current Harmonic Data	Same as Channel 1	word	R
34B2H - 34D0H	13490 - 13520	Channel 15 Current Harmonic Data	Same as Channel 1	word	R
34D1H - 34EFH	13521 - 13551	Channel 16 Current Harmonic Data	Same as Channel 1	word	R
34F0H - 350EH	13552 - 13582	Channel 17 Current Harmonic Data	Same as Channel 1	word	R
350FH - 352DH	13583 - 13613	Channel 18 Current Harmonic Data	Same as Channel 1	word	R
Channel 1 - Channel 18 single phase 3 line data					
352EH	13614	User 1 Three-Phase/Single Three Current Unbalance		word	R
352FH	13615	User 2 Three-Phase/Single Three Current Unbalance		word	R
3530H	13616	User 3 Three-Phase/Single Three Current Unbalance		word	R

Address (H)	Address (D)	Parameter	Range	Data Type	Access Property
3531H	13617	User 4 Three-Phase/Single Three Current Unbalance		word	R
3532H	13618	User 5 Three-Phase/Single Three Current Unbalance		word	R
3533H	13619	User 6 Three-Phase/Single Three Current Unbalance		word	R

DI Counter: 03H Read

Address (H)	Address (D)	Symbol	Parameter	Range	Data Type	Access Property
DI Counter						
3A00H - 3A01H	14848 - 14849	DI1	DI1 Pulse Count	0~4294967295	Dword	R
3A02H - 3A03H	14850 - 14851	DI2	DI2 Pulse Count	0~4294967295	Dword	R
3A04H - 3A05H	14852 - 14853	DI3	DI3 Pulse Count	0~4294967295	Dword	R
3A06H - 3A07H	14854 - 14855	DI4	DI4 Pulse Count	0~4294967295	Dword	R
3A08H - 3A09H	14856 - 14857	DI5	DI5 Pulse Count	0~4294967295	Dword	R
3A0AH - 3A0BH	14858 - 14859	DI6	DI6 Pulse Count	0~4294967295	Dword	R

AcuRev 2100 Series Power Meter

Address (H)	Address (D)	Symbol	Parameter	Range	Data Type	Access Property
3A0CH - 3A0DH	14860 - 14861	DI7	DI7 Pulse Count	0~4294967295	Dword	R
3A0EH - 3A0FH	14862 - 14863	DI8	DI8 Pulse Count	0~4294967295	Dword	R
3A10H - 3A11H	14864 - 14865	DI9	DI9 Pulse Count	0~4294967295	Dword	R
3A12H - 3A13H	14866 - 14867	DI10	DI10 Pulse Count	0~4294967295	Dword	R
3A14H - 3A15H	14868 - 14869	DI11	DI11 Pulse Count	0~4294967295	Dword	R
3A16H - 3A17H	14870 - 14871	DI12	DI12 Pulse Count	0~4294967295	Dword	R
3A18H - 3A19H	14872 - 14873	DI13	DI13 Pulse Count	0~4294967295	Dword	R
3A1AH - 3A1BH	14874 - 14875	DI14	DI14 Pulse Count	0~4294967295	Dword	R
3A1CH - 3A1DH	14876 - 14877	DI15	DI15 Pulse Count	0~4294967295	Dword	R
3A1EH - 3A1FH	14878 - 14879	DI16	DI16 Pulse Count	0~4294967295	Dword	R

Address (H)	Address (D)	Symbol	Parameter	Range	Data Type	Access Property
3A20H - 3A21H	14880 - 14881	DI17	DI17 Pulse Count	0~4294967295	Dword	R
3A22H - 3A23H	14882 - 14883	DI18	DI18 Pulse Count	0~4294967295	Dword	R
DI Scaled Value						
3A24H - 3A25H	14884 - 14885	DI1	DI1 Scaled Value	0~4294967295	Dword	R
3A26H - 3A27H	14886 - 14887	DI2	DI2 Scaled Value	0~4294967295	Dword	R
3A28H - 3A29H	14888 - 14889	DI3	DI3 Scaled Value	0~4294967295	Dword	R
3A2AH - 3A2BH	14890 - 14891	DI4	DI4 Scaled Value	0~4294967295	Dword	R
3A2CH - 3A2DH	14892 - 14893	DI5	DI5 Scaled Value	0~4294967295	Dword	R
3A2EH - 3A2FH	14894 - 14895	DI6	DI6 Scaled Value	0~4294967295	Dword	R
3A30H - 3A31H	14896 - 14897	DI7	DI7 Scaled Value	0~4294967295	Dword	R

AcuRev 2100 Series Power Meter

Address (H)	Address (D)	Symbol	Parameter	Range	Data Type	Access Property
3A32H - 3A33H	14898 - 14899	DI8	DI8 Scaled Value	0~4294967295	Dword	R
3A34H - 3A35H	14900 - 14901	DI9	DI9 Scaled Value	0~4294967295	Dword	R
3A36H - 3A37H	14902 - 14903	DI10	DI10 Scaled Value	0~4294967295	Dword	R
3A38H - 3A39H	14904 - 14905	DI11	DI11 Scaled Value	0~4294967295	Dword	R
3A3AH - 3A3BH	14906 - 14907	DI12	DI12 Scaled Value	0~4294967295	Dword	R
3A3CH - 3A3DH	14908 - 14909	DI13	DI13 Scaled Value	0~4294967295	Dword	R
3A3EH - 3A3FH	14910 - 148911	DI14	DI14 Scaled Value	0~4294967295	Dword	R
3A40H - 3A41H	14912 - 14913	DI15	DI15 Scaled Value	0~4294967295	Dword	R
3A42H - 3A43H	14914 - 14915	DI16	DI16 Scaled Value	0~4294967295	Dword	R
3A44H - 3A45H	14916 - 14917	DI17	DI17 Scaled Value	0~4294967295	Dword	R

Address (H)	Address (D)	Symbol	Parameter	Range	Data Type	Access Property
3A46H - 3A47H	14918 - 14919	DI18	DI18 Scaled Value	0~4294967295	Dword	R

DI Status: 02H Read

Address (H)	Address (D)	Symbol	Parameter	Range	Data Type	Access Property
DI Status						
0000H	0	DI1	DI1 Status	0: OFF 1: ON	Bit	R
0001H	1	DI2	DI2 Status	0: OFF 1: ON	Bit	R
0002H	2	DI3	DI3 Status	0: OFF 1: ON	Bit	R
0003H	3	DI4	DI4 Status	0: OFF 1: ON	Bit	R
0004H	4	DI5	DI5 Status	0: OFF 1: ON	Bit	R
0005H	5	DI6	DI6 Status	0: OFF 1: ON	Bit	R
0006H	6	DI7	DI7 Status	0: OFF 1: ON	Bit	R
0007H	7	DI8	DI8 Status	0: OFF 1: ON	Bit	R

AcuRev 2100 Series Power Meter

Address (H)	Address (D)	Symbol	Parameter	Range	Data Type	Access Property
0008H	8	DI9	DI9 Status	0: OFF 1: ON	Bit	R
0009H	9	DI10	DI10 Status	0: OFF 1: ON	Bit	R
000AH	10	DI11	DI11 Status	0: OFF 1: ON	Bit	R
000BH	11	DI12	DI12 Status	0: OFF 1: ON	Bit	R
000CH	12	DI13	DI13 Status	0: OFF 1: ON	Bit	R
000DH	13	DI14	DI14 Status	0: OFF 1: ON	Bit	R
000EH	14	DI15	DI15 Status	0: OFF 1: ON	Bit	R
000FH	15	DI16	DI16 Status	0: OFF 1: ON	Bit	R
0010H	16	DI17	DI17 Status	0: OFF 1: ON	Bit	R
0011H	17	DI18	DI18 Status	0: OFF 1: ON	Bit	R

Alarm Log

Address (H)	Address (D)	Parameter	Range	Data Type	Access Property
3700	14080	Alarm status of currently read record		integer	R
3701	14081	The serial number of the parameter currently being read	0 - 370 (When wiring mode is Network, 0 - 400)	integer	R
3702	14082	The current reading recorded -limit or restore the parameters' values		integer	R
3703 - 3709	14083 - 14089	Occurrence time of current read record	Year, month, day, hour, minute, second, millisecond	integer	R
370A	14090	The group number of the latest alarm record	1- 2 0 , 0 means no alarm record	integer	R
370B	14091	Alarm record number currently read	1- 2 0, other values are invalid	integer	R/W
370CH - 3715H	14092 - 14101	First . 1 Article alarm log (record format with the current read)	The format is the same as the current reading record		R
3716H - 371FH	14102 - 14111	Article 2 Alarm record (the format is the same as the current reading record)	The format is the same as the current reading record		R
3720H - 37D3H	14112 - 14291	Of 3 ~ section 20 is Article alarm records			

Alarm status: the high byte indicates the alarm channel number 1-10, the low byte bit0 is 1 indicates that the alarm is generated, and 0 indicates that the alarm is restored

Only one alarm record can be read at a time, by reading the setting of (a current reading alarm record number)

System Event

Address (H)	Address (D)	Parameter	Range	Data Type	Access Property
3800H - 3805H	14336 - 14341	The time when the current system event record was read	Year, month, day, hour, minute, second	word	R
3806H	14342	Event ID currently reading the system event record	1-16 Indicates 1-16 events	word	
3807H	14343	The latest event record group number	1-100 , 0 means no	word	
3808H	14344	The record number of the currently read event	1-100 , other values are invalid	word	R/W
6000H - 6006H	24576 - 24582	Article 1 System Event Record (The format is the same as the current read system event record)	(The format is the same as the current reading system event record)		R
6007H - 62BBH	24583 - 25275	Of 2 Article ~ section 100 Article System Event Log (reading system event format with the current record)	(The format is the same as the current reading system event record)		R



MAKE ENERGY USAGE SMARTER

ACCUEENERGY INC.

440 Comstock Road
Toronto, ON M1L 2H6, Canada

TF: 1-877-721-8908

INT: +1-416-497-4100

FAX: +1-416-497-4130

E: marketing@accuenergy.com

ACCUEENERGY SOUTH AFRICA (PTY) LTD

Castle Walk Corporate Park,
Block B, Cnr. Nossob & Swakop Street
Erasmuskloof, Pretoria, 0181
South Africa

TF: +27 (0) 87 802 6136

