

AcuPanel 9106X

Pre-Wired Multi-Channel
Submetering Control Panel
Datasheet



DESCRIPTION

The AcuPanel 9106X is a convenient, pre-wired meter enclosure that delivers streamlined meter deployment in OEM or retrofit projects. It is ideal for when installation inside an electrical distribution panel is unavailable, in harsh environments to safeguard instrumentation against the elements, or to limit the time and complexity of installation. Each AcuPanel undergoes rigorous quality testing to ensure years of dependable service.

FEATURES

- + The NEMA 4X rated polycarbonate enclosure is suitable for both indoor and outdoor use.
- + The lockable, plug-and-play housing provides protection against unwanted tampering and the elements
- + Clean, factory pre-wiring for fast, reliable installation. Includes all necessary fuses.
- + Required components are all pre-installed and clearly labeled.
- + Self-powered panel does not require a separate power supply.
- + Enclosure can be drilled for custom conduit connections to suit any application.
- + Simple grounding is included inside each enclosure.
- + Compatible with the AcuRev 2100 Series multi-circuit submeter.

KEY FEATURES

Multi-Circuit Submetering

- + Features AcuRev 2100 multi-circuit submeter.
- + ANSI C12.20 Class 0.5 & IEC62053-22 Class 0.5s compliant revenue-grade metering.
- + Measure 18 single-phase or 6 (or 9) polyphase circuits simultaneously.
- + Measures demand & peak demand, including total & demand within 30 min window.
- + Measures active, reactive & apparent energy.

UL Certified

- + UL Listed & UL 508A Certified
- + Rigorously tested to meet UL safety standards.
- + Assembled with UL-approved components to reduce electrical hazards.
- + Every AcuPanel 9106X model is tested for reliable performance.

Self-Powered Design

- + No separate power source required.
- + Supports direct line-to-line connection for simplified wiring.
- + Reduces installation time for faster deployment.
- + Ideal for OEM projects needing efficient, quick setup.

NEMA 4X Rated Enclosure

- + Built with NEMA 4X rated polycarbonate enclosure.
- + Protects against dust, water, extreme temperatures, and harsh environments.
- + Suitable for indoor and outdoor use, safeguarding sensitive equipment.

Power Quality Analysis

- + The AcuRev 2100 monitors power quality parameters, including voltage and current THD, voltage crest factor, current K factor, and unbalance.
- + Measures individual voltage and current harmonics up to the 31st order.
- + Real-time monitoring with data logged in the built-in 8GB non-volatile memory.

Custom OEM Solutions

- + Showcase your logo with personalized branding.
- + Integrate custom OEM components like gateways, cellular modems, or power supplies.
- + Adjust panel dimensions to fit specific space or equipment requirements.
- + Work with our energy metering specialists for a tailored panel solution.

Pre-Wired & Factory Tested

- + Components are pre-wired, factory assembled, colour-coded, and clearly labelled.
- + Minimizes wiring errors and simplifies maintenance.
- + Speeds up installation while ensuring long-term reliability.

Secure Design

- + Lockable enclosure designed to prevent unauthorized access.
- + Metrology seals defend against tampering.
- + Ensures data integrity and extend lifespan of critical devices.

APPLICATIONS

- + Commercial Complex & Mall
- + Apartment & Condominiums
- + Hospitals & Public Services
- + Hotels & Office Buildings
- + Tenant Submetering & Billing
- + Branch Circuit Monitoring
- + Energy Management Systems
- + Data Centers
- + LEED Project

ACUPANEL SPECIFICATIONS

AcuPanel 9106X



AcuRev 2100

| | |
|--------------------------|--|
| Compatible Meters | |
| Application | Indoor or outdoor installations that require exceptional environmental protection and weather resistance |
| Safety Certifications | UL508A |
| NEMA Rating | NEMA 4X |
| Material | Polycarbonate |
| Anti-Corrosive | • |
| Dust Proof | • |
| Suitable for Indoor Use | • |
| Suitable for Outdoor Use | • |
| Pre-Wired | • |



EACH STANDARD, PRE-WIRED ENCLOSURE INCLUDES:

- + Terminals for voltage inputs
- + Terminals for current inputs
- + Control transformer
- + Three industrial-grade fuses

WIRING DIAGRAMS

AcuPanel 9106X

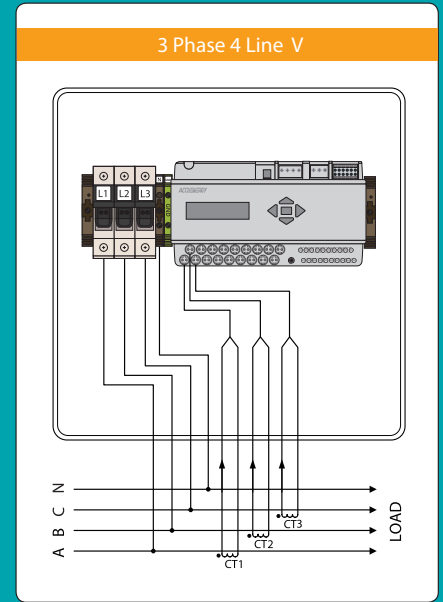
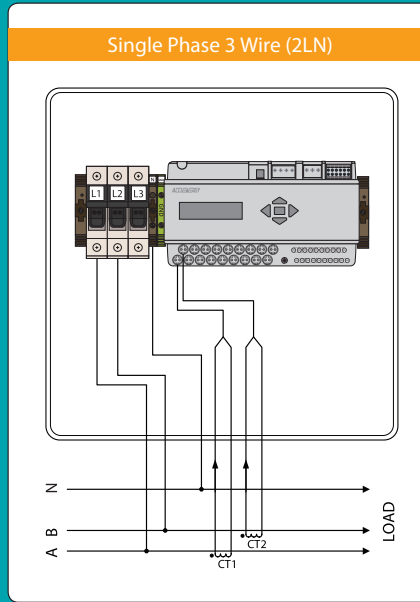
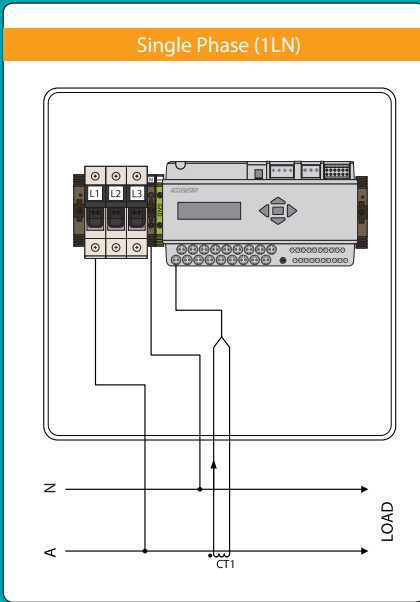

DIMENSIONS

AcuPanel 9106X Polycarbonate Panel

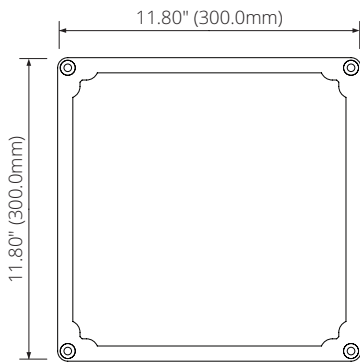

Front View

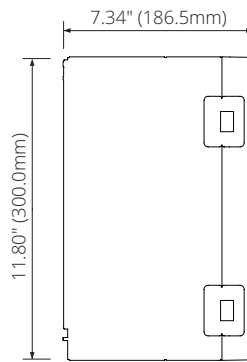

Side View

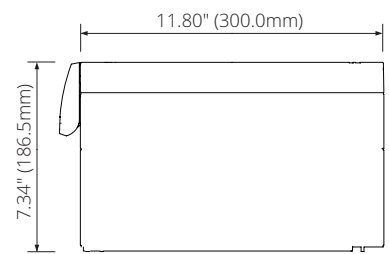

Bottom View

ACCESSORIES & COMPONENTS

AC Current Transformers

Our high-accuracy revenue-grade split-core and solid-core (AcuCT S77) current transformers offer superior accuracy and exceptional performance across the industry.



Test Lead & Voltage Clip

The testing leads feature dual banana connectors for secure connections, while the voltage clip, encased in EPR insulation, ensures CAT IV safety compliance and includes a robust alligator clamp for reliable use.



SnapOn CT Connectors

Comes with SnapOn CT connector heads that plug directly into the AcuRev 2100 submeter. Order extra connectors to outfit additional current transformers or keep a supply on-hand as replacements.



AcuCT C CT Converter

The AcuCT C is a 5A to 80mA/100mA converter. Paired with a 5A primary current transformer, it converts the signal to either 80mA or 100mA secondary current.

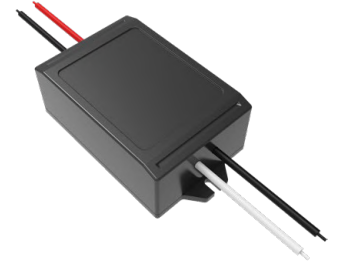

SOFTWARE INTEGRATION

AcuCloud

AcuCloud is a robust cloud-based energy management platform that allows user-friendly access to data from Accuenergy and other power meters. It aggregates energy data management by offering rapid data retrieval, in-depth analysis, and seamless integration for importing and exporting data to external systems.



ORDERING INFORMATION

Pre-Wired Control Panel with AcuRev 2100

| + Pre-Wired Panel | - Current Input | - Communication | - Control Power |
|---|--|---------------------------------------|-----------------------------------|
| AcuPanel 9106X-2110: NEMA 4X Indoor /Outdoor Waterproof Polycarbonate Panel | mV: 333mV CT or Rogowski Coil Input | WEB2: RS485 + Dual RJ45 + WiFi | P1: 100-415Vac, 100-300Vdc |
| | mA: 80mA or 100mA | 485: RS485 | P3: 480Vac |
| | | | P4: 600Vac |

Ordering Example: **AcuPanel 9106X-2110-mV-WEB2-P3**



Accuenergy Inc.

Los Angeles - Toronto - Pretoria
 North America Toll Free: 1-877-721-8908
 Web: www.accuenergy.com
 Email: marketing@accuenergy.com

Revision Date: March 2025 Version: 1.0.4
 Specs Subject To Change Without Notice.



ISO 9001, 14001 & 45001 Certified